

wireless world

FEBRUARY 1978 40p

Microwave hybrid i.c.s
Radio telescope

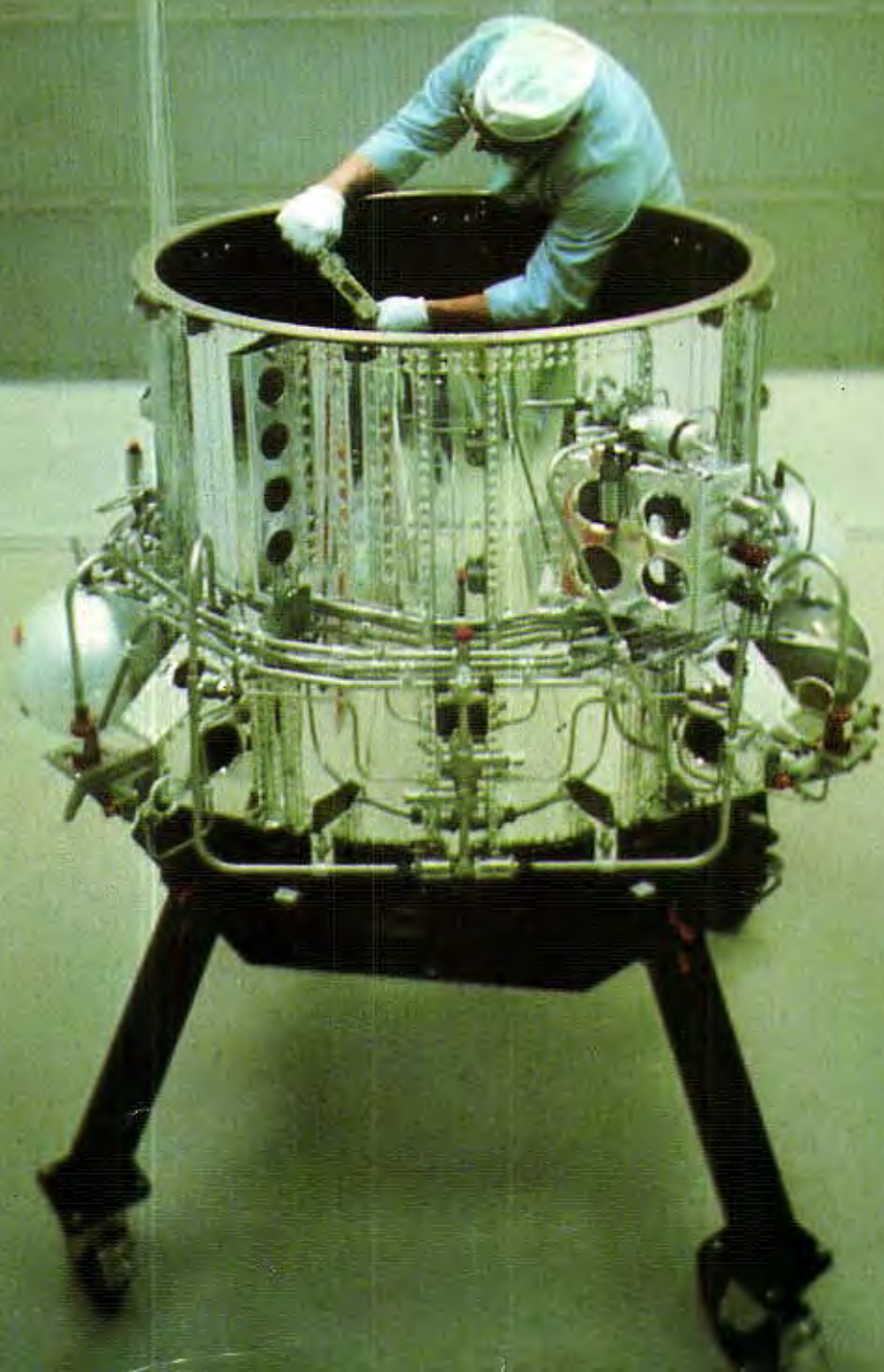

Australia \$A7.20
Canada \$1.75
Denmark Kr. 11.00
Germany Dem. 4.50
Greece Dr. 47.00
Holland Dfl. 4.50
Italy L. 11.00
New Zealand \$NZ1.90
Norway Kr. 11.00 incl. postage
Singapore M. \$3.25
Spain Ptas. 80.00
U.S.A. \$1.65

The better value box for mobile radio servicing.

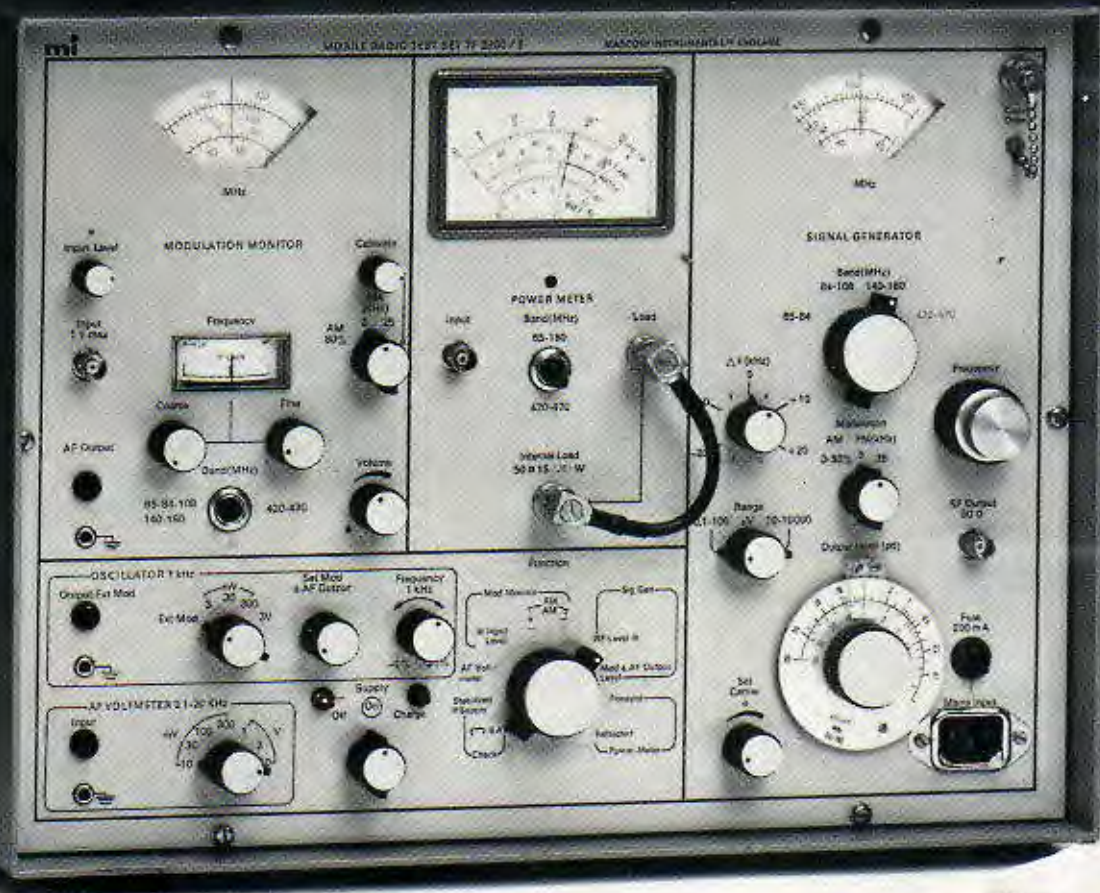

By combining all mobile radio servicing instruments in one portable unit, Marconi Instruments' Mobile Radio Test Set, TF 2950, streamlines your testing and servicing operation. And it is realistically priced.

Signal generator, a.f. voltmeter, modulation monitor, power meter (in-line and absorption) and a.f. oscillator are housed in a compact and robust cabinet - measuring only 315 mm high, 420 mm wide and 230 mm deep, and weighing only 16 kg.

TF 2950 is suitable for all a.m./f.m. mobile radio equipment and is available in a number

of versions to cover a wide frequency range.

For maximum convenience, the equipment operates from internal, rechargeable batteries or mains. A battery state meter is incorporated.

Marconi Instruments' TF 2950 gives you single-handed portability to meet all your mobile test needs.

Put it to the test.

Write or telephone for a full technical description and, if this whets your appetite further, we will be happy to arrange a demonstration.

mi MARCONI INSTRUMENTS

Marconi Instruments Limited · Longacres · St. Albans · Hertfordshire · England AL4 0JN · Tel: (0727) 59292 · Telex: 23350
Marconi Electronics Inc · 100 Stonehurst Court · Northvale · New Jersey 07647 USA · Tel: (201) 767-7250 · Twx: 710-991-9752
Marconi Instruments · 32 avenue des Ecoles · 91600 Savigny-Sur-Orge · France · Tél: 996.03.86 · Télex: 600541.F
Marconi Messtechnik GmbH · 8000 München 21 Jörgstrasse 74 · West Germany · Tel: (089) 58 20 41 · Telex: 5 212642



Front cover shows *Tiros-N*, an advanced environmental satellite designed and constructed by RCA at Princeton, N.J., USA.

IN OUR NEXT ISSUE

Precision pickup arm design. Practical analysis of parameters such as tracking and tracing errors, cartridge resonance, skating force, lateral balancing and arm length.

Semiconductor memories, a survey of types on the market used in microcomputers and other digital systems.

Colouration in loudspeakers, discusses sources of unwanted resonances and methods of eliminating them.

Current issue price 40p, back issue (if available) 50p, at Retail and Trade Counter, Paris Garden, London SE1.

By post, current issue 55p, back issues (if available) 50p, order and payments to Room 11, Dorset House, London SE1 9LU.

Editorial & Advertising offices: Dorset House, Stamford Street, London SE1 9LU.

Telephones: Editorial 01-261 8620, Advertising 01-261 8339.

Telegrams/Telex: Wlworld Businesspres 25137 BISPRS G. Cables: Etheworld, London SE1.

Subscription rates: 1 year: £7.00 UK and overseas (\$18.20 USA and Canada).

Student rate: 1 year, £3.50 UK and overseas (\$9.10 USA and Canada).

Distribution: 40 Bowling Green Lane, London EC1R 0NE. Telephone 01-837 3636.

Subscriptions: Oakfield House, Perrymount Road, Haywards Heath, Sussex, RH16 3DH. Telephone 0444 59188. Subscribers are requested to notify a change of address.

USA mailing agents: Expeditors of the Printed Word Ltd, 527 Madison Avenue, Suite 1217, New York, NY 10022. 2nd-class postage paid at New York.

IPC Business Press Ltd, 1978
ISSN 0043 6062

ibpa

International Business Press Association

ABC

Association of British Circulation

wireless world

ELECTRONICS / TELEVISION / RADIO / AUDIO

FEBRUARY 1978 VOL 84 NO 1506

25 Viewdata needs encouragement

26 A basic radio telescope

by J. R. Smith

31 News of the month

BS9000 and protectionism / EEA plan for CB / Turntable war

35 Low-noise cassette deck — postscript

by J. L. Linsley Hood

41 Reliability

by H. R. Henly

46 Microwave hybrid integrated circuit technology

by R. Davies and B. H. Newton

51 Letters to the editor

Amateurs' power levels / p.m.r. spectrum utilisation / amplifier distortion

55 Radio on the flight deck — 2

by A. Bramson

58 Circuit ideas

Precision timer / variable-speed radio control motor / Triple voltage power supply

63 P.c.b. layout for high-speed Schottky t.t.l.

by D. Walton

66 Microcomputer design — 4

by C. D. Shelton

68 World of amateur radio / 77 New Products / 80 Sidebands by "Mixer"

69 Automatic impedance plotter

by T. F. North

73 Further topics from Radar 77 conference

75 Single-sideband transceiver design

by B. A. Austin

124 Appointments vacant

136 Index of advertisers

Our ideal is
a pipeline to you

SO WE BUILT ONE

General Instrument Microelectronics Limited are the leaders in microcircuits for consumer/telecommunications and other applications.

Our distributors form a direct pipeline from us to you. For easy access to the widest range of advanced microelectronics call them and ask for a free copy of our latest shortform catalogue.

UK DISTRIBUTORS:

- Semiconductor Specialists Ltd.**, Premier House, Fairfield Road, Yiewsley, West Drayton, Middlesex. Tel: West Drayton (08954) 46415 Telex: 21958
- Semicomps Ltd.**, Wellington Road, London Colney, St. Albans, Herts. Tel: Bowmans Green 24522 Telex: 21108
- Semicomps Northern Ltd.**, Ingrow Lane, Keighley, W. Yorks. Tel: Keighley 65191 Telex: 517343
- Semicomps Northern Ltd.**, East Bowmont Street, Kelso, Roxburghshire. Tel: Kelso 2366 Telex: 72692
- Semicomps Ltd.**, 3 Warwick House, Station Road, Kenilworth, Warwickshire. Tel: 0926 59411 Telex: 312212
- Crellon Electronics Ltd.**, 380 Bath Road, Slough SL1 6JE. Tel: Burnham (06286) 4434 Telex: 847571
- Crellon Electronics Ltd.**, 24 Broughton Street, Cheetham Hill, Manchester. Tel: 061-831 7471 Telex: 688304
- Crellon Electronics Ltd.**, 192 Moulsham Street, Chelmsford, Essex CM2 0LG. Tel: 0245 69545 Telex: 99443
- S.D.S. Components Ltd.**, Jubilee Unit, The Airport, Eastern Road, Portsmouth, Hants. Tel: 0705 65311 Telex: 86119
- S.D.S. Components Ltd.**, 111 Alexandra House, East Kilbride, Glasgow G74 1LX. Tel: 0552 48617 Telex: 778044

We help you compete

GENERAL INSTRUMENT MICROELECTRONICS LTD

57-61 Mortimer Street, London W1N 7TD England
Telephone: 01-636 2022 Telex: 23272



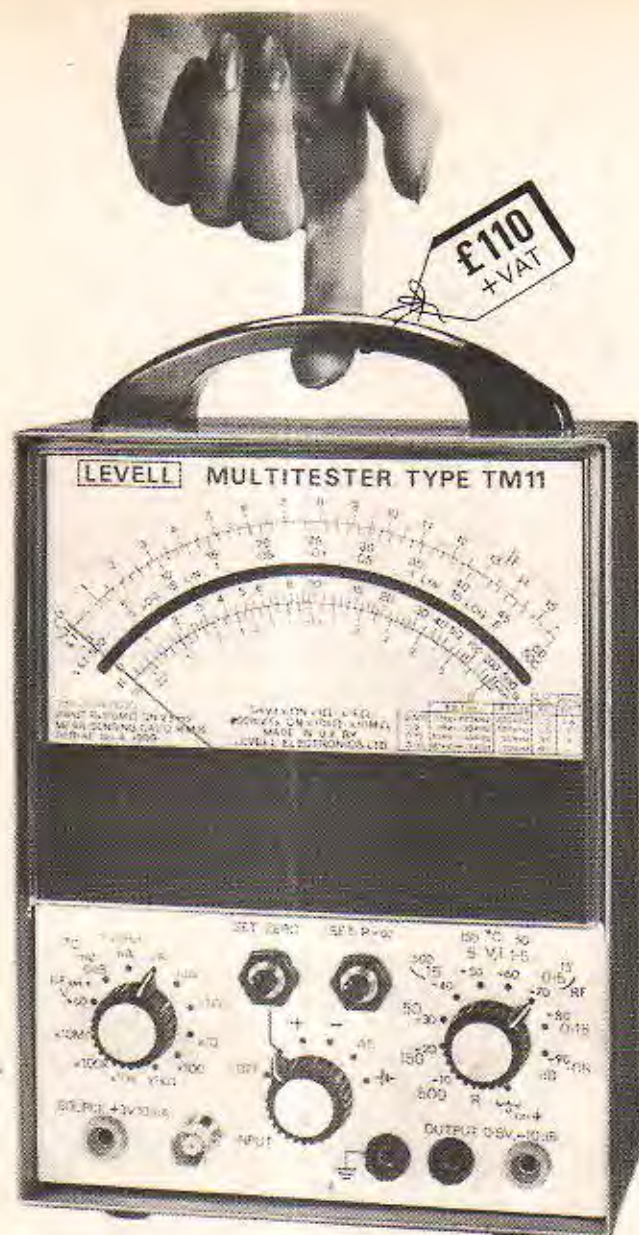

VERSATILE

RELIABLE

PORTABLE

120 BASIC RANGES

- AC V, I & dB : 50 μ V/500V fsd, 50pA/500mA fsd, -90dB/+50dB mid scale. Acc. $\pm 1.5\%$ fsd above 500 μ V & 500pA. Response 3Hz/200kHz above 500 μ V and 500nA. Input R = 100M Ω on volts.
- DC V, I & NULL : 150 μ V/500V fsd, 150pA/500mA fsd, polarity reversible. Acc. $\pm 1.5\%$ fsd above 500 μ V & 500pA. Input R = 100M Ω on volts. 5 Null ranges have centre zero lin/log scale covering ± 4 decades.
- RESISTANCE : 0.2 Ω /10G Ω in 7 ranges, polarity reversible. Low test voltage for solid state circuits.
- LEAKAGE at 3V : Uses 3V source with current ranges to test capacitors, diodes and resistance up to 100G Ω .
- VOLT DROP at 10mA : Uses 10mA source with voltage ranges to test diodes, LED's and resistance down to 10m Ω .

30 OPTIONAL RANGES

- RF VOLTS : 0.5V/500V fsd, 10kHz/1GHz, using RF Probe. Price £22 + VAT.
- HIGH VOLTS : 1.5kV/50kV fsd, AC/DC, using HV Probe. Price £16 + VAT.
- HIGH CURRENT : 1.5A/50A fsd, AC/DC, using Current Shunt. Price £15 + VAT.
- TEMPERATURE : -150 $^{\circ}$ C/+500 $^{\circ}$ C fsd in 7 ranges using Temperature Probe. Price £38 + VAT.

The instrument operates from a 9 volt battery, life 1000 hrs., or, AC mains when optional Power Supply Unit is fitted. Size is 240mm x 150mm x 80mm. Weight is 1.75 kg. Meter scale length is 140mm. Leather case is available at £13 + VAT.

LEVELLE ELECTRONICS LTD.

MOXON STREET, BARNET, HERTS., ENGLAND, EN5 5SD
TEL: 01-449 5028/440 8686

WW — 051 FOR FURTHER DETAILS

MAPLIN

in a modern world of electronics

AUDIO MIXER

A superb stereo audio mixer. It can be equipped with up to 16 input modules of your choice and its performance matches that of the very best tape-recorders and hi-fi equipment. It meets the requirements of professional recording studios, FM radio stations, concert halls and theatres. Full construction details in our catalogue. A component schedule is available on request.



THE "DRUMSETTE" RHYTHM GENERATOR

Organists, pianists, guitarists... an automatic drum set to accompany you! Nine highly realistic instruments play fifteen different rhythms. Fifteen rhythm-select touch switches and a touch plate for stop/start without rhythm change gives absolute ease of operation. Build it yourself for under £65 including smart leak-effect cabinet. See it and hear it in our shop! Send for full construction details now: MES 49. Price 25p.



INTEGRATED CIRCUITS

Over 35 pages in our catalogue devoted to hundreds of useful I.C.s. All with data, pin connections and many with applications circuits and projects to build. Post the coupon now!



T.V. GAME

A fascinating TV game kit that plays football, tennis, squash and practice for only £21.59. Reprint of construction details 35p. Add-on rifle kit only £10.60.

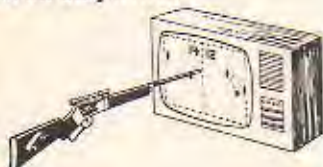

WHO SAYS THE MAPLIN CATALOGUE'S WORTH HAVING??

"In our 'musts' for readers-to-collect list" — P.E.
"contains... just about everything the DIY electronics enthusiast requires." — P.W.
"probably the most comprehensive catalogue we have ever come across." — E.E.
"has been carefully prepared and is very well presented." — R.E.C.
"make the job of ordering components an easy, accurate and enjoyable pastime." — P.W.
"only one word describes the publication — superb!" — E.T.J.
OVER 60,000 COPIES SOLD
DON'T MISS OUT! SEND 60p NOW
MAPLIN ELECTRONIC SUPPLIES
P.O. Box 3, Rayleigh, Essex SS6 8LR
Telephone: Southend (0702) 715155
Shop: 284 London Road
Westcliff-on-Sea, Essex
(Closed on Monday)
Telephone: Southend
(0702) 715157

SYNTHESISER

The International 4600 Synthesiser. A very comprehensive unit. Over 400 sold. We stock all the parts costing less than £500 including fully punched and printed metalwork and a smart teak cabinet. Far less than half what you'd pay for a ready made synthesiser of equal quality. Specification on request, full construction details in our construction book £1.50.



Our bi-monthly newsletter keeps you up to date with latest guaranteed prices — our latest special offers — details of new projects and new lines. Send 30p for the next six issues (5p discount voucher with each copy).

POST THIS COUPON
NOW FOR YOUR COPY OF OUR CATALOGUE
PRICE 60p

Please rush me a copy of your 216 page catalogue. I enclose 60p, but understand that if I am not completely satisfied I may return the catalogue to you within 14 days and have my 60p refunded immediately.

NAME

ADDRESS



WW-017 FOR FURTHER DETAILS

PLASTIC FASTENERS FOR ELECTRONICS

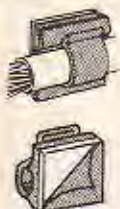

SELF-ADHESIVE CABLE CLIPS are a quick and simple means of securing cables, cords and small looms to flat surfaces. No drilling or fixing screws necessary. The peel-off backing is removed immediately before placing the clip. The coating adheres to most clean, flat surfaces and withstands a wide range of humidity and temperature. Cable clips are moulded in natural nylon and have rounded edges to prevent damage to the cables.

CABLE STRAPS are semi-permanent fasteners for strapping wires and cables into tight, compact looms. The ratchet fastener is adjustable and can be released by pinching-in the sides of the fastener head. Cable straps are made from black nylon.



WIRE TIES are a flexible means of fastening wires and small cables into orderly, compact looms. They are quick and easy to fit and can be re-used, greatly reducing re-loomng times. Wire ties are made from nylon and are available in various sizes each determined by a different colour.

The **P.C. BOARD GUIDE** is a self-retaining edge support for printed circuit boards. It has good panel retention and grips p.c. boards firmly and securely. The guide is available in two types of material - yellow acetal or grey Noryl, for high temperature and voltage applications.



P.C. BOARD SPACERS are simple to fit, one-piece mouldings for use with p.c. boards. They have a self retaining shank for fastening into panels and a T-shaped anchor for securing p.c. boards of 0.062" thickness. They have good resistance to vibration and are suitable for board-to-board or board-to-chassis use.



P.C. BOARD STAND-OFFS are quickly assembled, self-retaining panel supports for p.c. boards. Made from natural (off white) nylon and have good resistance to vibration. Suitable for panels up to 0.079" thickness. Stand-Offs accept a No. 4 self-tapping screw.

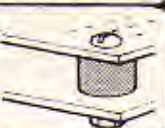

PLASTIC RIVETS fasten panels, fittings and name plates to metal plastic and wood. Resilient enough to fix into brittle materials like fibreglass, hardboard and glass. Shank, head and pin are one piece. Fixing is by driving the pin through the head into the space between the legs, gripping the work.

DRIVE FASTENERS hold two or more panels together. Easily fixed, normally by thumb pressure. No special tools required. Boat-shaped **DRIVE** Fasteners are for panels of thin and medium thickness and are removable. Ribbed **DRIVE** Fasteners are used in blind holes where hole length exceeds length of shank.



PLASTIC HOLE PLUGS are quick, inexpensive means of plugging unwanted holes. Hole Plugs keep out dust, dirt and moisture. Attractively shaped heads give a neat finish. The snap action grip of the Hole Plug makes a vibration resistant seal. Hole Plugs are made from nylon and are non-corrosive.

LOKUT ANCHORS are used to strengthen holes by providing additional screw thread engagement in materials where self-tapping screws would be unsatisfactory. Made from high strength nylon and used in insulation, and electrical chassis work. Easily fitted by hand.



1000's OF OTHER TYPES OF PLASTIC AND METAL FASTENERS
LEAFLETS ON REQUEST

HARMSWORTH

HARMSWORTH, TOWNLEY & CO. LTD.
HAREHILL TODMORDEN LANCS OL14 5JY
Phone TODMORDEN 2601 (STD 070-681 2601)

WW-027 FOR FURTHER DETAILS



Eimac tubes fly everywhere



Eimac stock popular tube types duty free, at Zürich Airport.

For fast, competitive service, contact:
Bob Bowles, Eimac Division,
Varian AG, P. O. Box, 6300 Zug, Switzerland
Tel. 042 / 31 66 55
Telex 78 789 or 78 841
Sales offices in:
Zug, Switzerland and
Paris, London, Munich, Torino,
Amsterdam, Brussels, Stockholm.



WW-045 FOR FURTHER DETAILS

F.M. TUNERS, MODULES & KITS by

Icon Design



This tuner must surely provide the best value for money available today. Combining the best of the modules shown below, it includes a full digital readout of frequency to a resolution of 0.1 MHz, so that exact station identification can be made. In addition, six pre-set stations may be selected by touch controls having internal solid state lamps, while manual tuning allows easy searching for distant stations under the guidance of the digital meter.

A switchable mute system allows reception of the weakest stations while muting inter-station noise and spurious responses. Perfect reception is assured by not permitting any station to be heard which is far enough out of tune to cause distortion. The tuning indicator lamp provides a means of very fine tuning, and is automatically extinguished between stations. A powerful A.F.C. system is also incorporated which holds all stations in tune, while not preventing manual tuning.

Good stereo reception is assured by the use of a phase locked decoder with full 'birdie' and spurious output filtering.

Finally, but not least, the external appearance and styling bring a fresh new look to Hi-Fi. The sturdy wooden cabinet is finished in mat teak veneer, housing an attractive gold and brown anodised aluminium front panel, which carries black controls and inscriptions. The indicator lamps and digital displays are in red, giving the finishing touches to a tuner you will be proud to own.

	Tuner	
T2 TOUCH TUNED	£121.00	Kit
T3 DIGITAL (AS SHOWN)	£149.00	£109.00
		£139.00

MAIN RECEIVER MODULE M1

We have claimed before that this F.M. system is the most advanced on the market, and after nearly three years we repeat our claim. Some have borrowed ideas, some have not, but no other tuner gives you all the features of this unit. How many tuners mute the spurious tuning effects found at either side of a correctly tuned station? How many tuners fade the sound out as you tune too far off station for good quality sound? How many tuners kill the tuning indicator so that it does not indicate when there is no station there? How many offer you drift free tuning? We could go on. If you want a tuner that has been well thought out and engineered, start with this module.

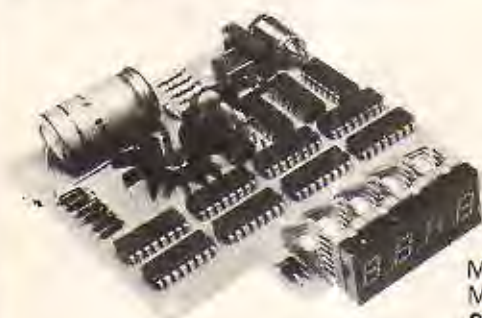

**M6
MODULE ONLY
£44.40**

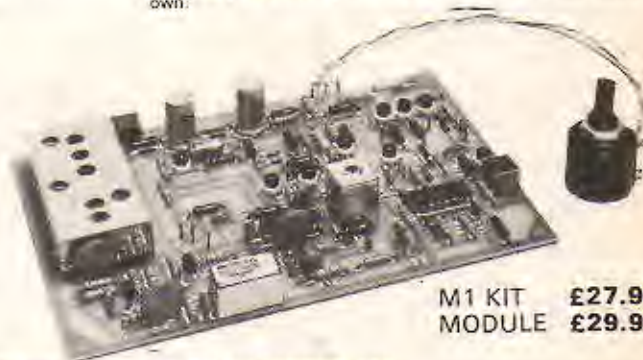

**M1 KIT £27.95
MODULE £29.95**

DIGITAL FREQUENCY METER M6

We are very proud of this one. We don't have to say it's the best, as far as we know it's the only one! On a board less than 4" square is all the electronics of a stable counter with i.f. offset (added) and a stabilized power supply! With the aid of a small daughter board (not shown) which fits neatly into the above module (M1), the exact station frequency is displayed to the nearest 0.1 MHz. It's a tuning scale 20" long with accurate calibrations every 0.1"! You get the transformer, daughter board (ready wired in), polarized filter, and a list of station frequencies. What more do you want?

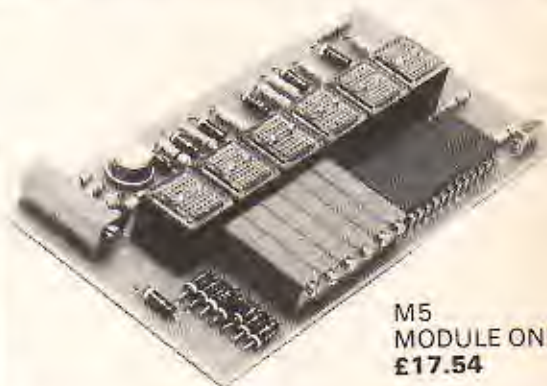

**M5
MODULE ONLY
£17.54**

NEW TOUCH TUNE MODULE M5 Mk. 2

This new module includes several new features for no increase in price. Improved sensitivity with "touch to earth" mode is coupled with remote stopping and changeable "power up" selection. Brighter lamps are also added and 20 turn cermet pre-sets provide reliable pre-selection of stations.

FULL CABINET/METALWORK KIT

(Including all Nuts and Bolts, Plugs and Sockets, etc.)

£28.16

OTHER MODULES etc.

M2 Stereo decoder	£8.36	kit	£6.84
M4 Power supply	£6.93	kit	£6.49
SL1310 decoder IC	£2.15		
TBA750 f.m. i.f.	£1.71		
20v regulator IC	£1.65		
LP1186 front-end	£8.53		
Filter, SFJ10 7MA	£1.71		
7 segment L.E.D. (c/a)	£1.99		
Descriptive booklet	£0.50		(£1.50 export)
Small orders (< £5.00)	£0.50		Handling charge



ALL PRICES + 12.5% VAT, U.K. ONLY

Overseas: Sales by Pro-Forma Invoice, send no money.

TO ICON DESIGN

33 Restrop View
Purton, Wilts., SN5 9DG

Please supply data on: (Circle as required)

M1 M2 M4 M5 Mk. 2 M6 ALL

Address label

Block letters

.....
.....
.....

Mini-priced breadboards for maxi-sized projects.

Experimenter® low-cost solderless breadboards are the first in the world specially designed for 0.3" and 0.6" pitch DIP's.

They clip together by an exclusive interlocking system in any configuration, (just like dominoes), so you arrange the breadboards to suit your circuit, not vice-versa.

They are precision moulded from durable, flame-retardant plastic, and feature alphanumeric coding for easy circuit building, and non-corrosive, pre-stressed nickel-silver alloy contacts — reliable for well over 10,000 insertions.



EXCLUSIVE INTERLOCKING SYSTEM.

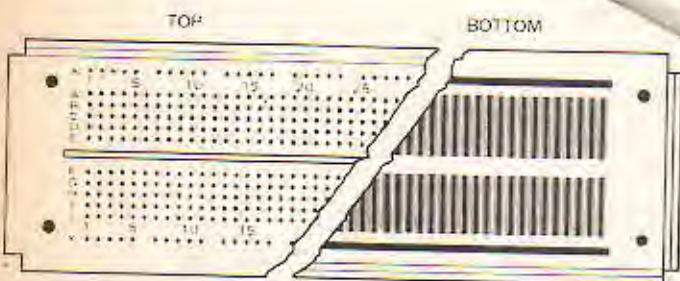

Contact resistance is a mere 0.4 mΩ and interterminal capacitance is typically less than 5 pF. The **Experimenter** is usable to over 100 MHz.

Experimenter 600 and 650 models are ideal for RAM's ROM's and PROM's (0.6" centre IC's) while the 300 and 350 models are for smaller DIP's (0.3" centres). All four models, of course, also take all standard components, the 0.1" grid being compatible with transistors, diodes, LED's, capacitors, resistors, pots — in fact any component with lead sizes between 0.015" and 0.032"



A useful quad bus strip (EXP4B) further

Model	Length"	Width"	Centre channel"	5-way tie points	Bus	Price
EXP300	6.0	2.1	0.3	94(470)	2(80)	£6.77
EXP350	3.6	2.1	0.3	46(230)	2(40)	£3.69
EXP600	6.0	2.4	0.6	94(470)	2(80)	£7.35
EXP650	3.6	2.4	0.6	46(230)	2(40)	£3.99
EXP4B	6.0	1.0	N/A	N/A	4(160)	£2.83

expands the versatility of the system for the MPU user.

Experimenter breadboards can be used alone or mounted on any convenient flat surface, thanks to moulded-in mounting holes and vinyl insulation backing that prevents short circuits. Mount them from the front with 4-40 flathead screws or from the rear with 6-32 self tapping screws.

But however you use them, **Experimenter** breadboards are the quickest and easiest way to build and test circuits. If you're working on IC's, MPU's, memories,

Get your hands on an **Experimenter** and stop wasting time!

displays or any other circuits, buy the breadboards that are designed for you.

Ring us (01-890 0782) with your Access, Barclaycard or American Express number and your order will be in the post that night.

Alternatively, send a cheque, or postal order (don't send credit cards!) and it still only takes a few days.

Otherwise ask for our complete catalogue.

CONTINENTAL SPECIALTIES CORPORATION



The Industrial Tube Guide

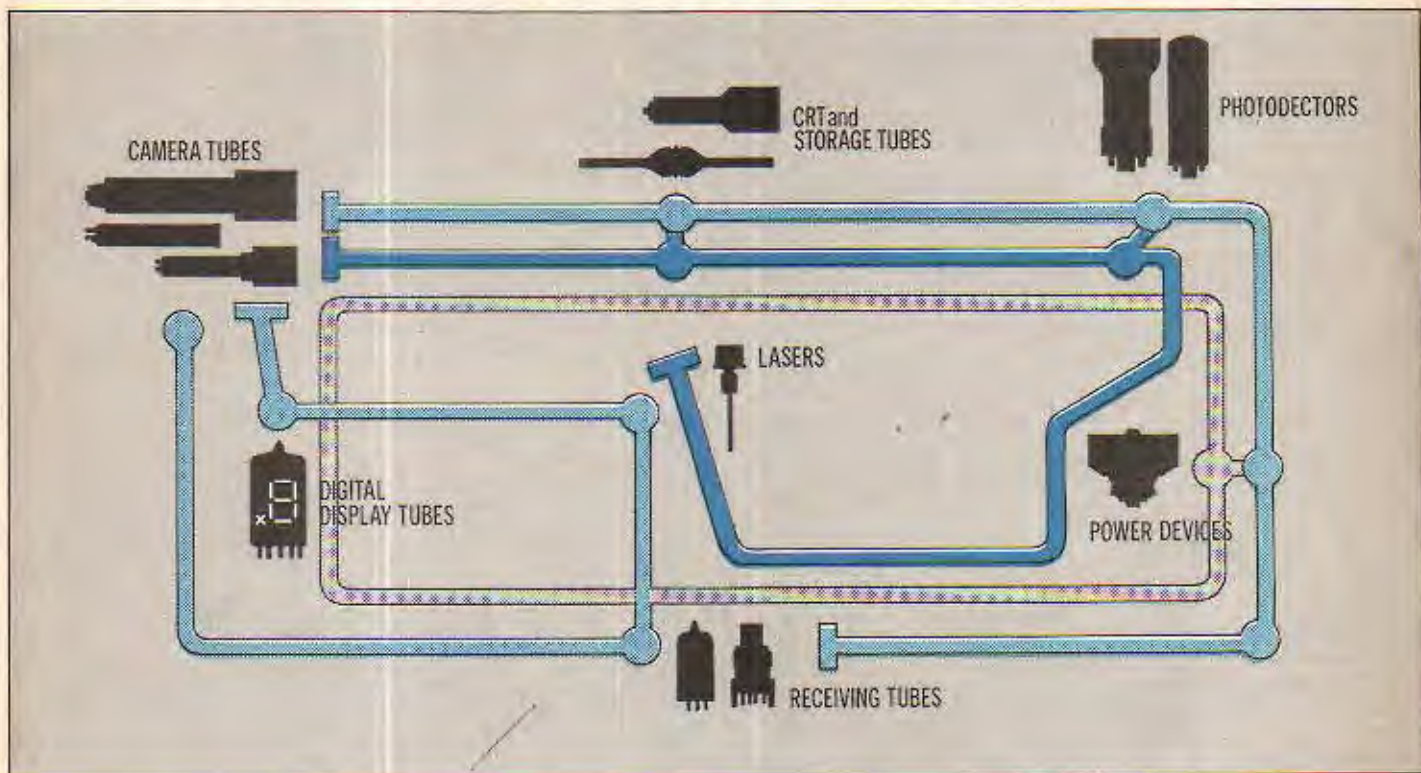

RCA offer the definitive guide to industrial tube products. A collection of literature, full of information on a vast range from camera tubes to digital display tubes. Lasers to photomultipliers. Power devices to

receiving tubes. LEDs to CCD Image Sensors. It can save time, trouble and money, yet it's free on request.

The brochures set out clearly and conveniently, data on a wide and diverse range of product groups. Apart from initially grouping products into types and outlining major parameters, there are expanded catalogues on most products.

These include selection, replacement, equivalents and characteristics tables to help you narrow your choice.

If your business involves industrial tubes, this is one guide you should not be without.

Just call or send the coupon.



Crellon Electronics Ltd.,
(Incorporating ECS and GDS Sales)

RCA

Crellon Electronics Ltd.,
380 Bath Road, Slough, Berks SL1 6JE.
Tel: Burnham (06286) 4434 Telex: 847571
Please send me the RCA Industrial Tube Guide

WW 2/78

Name

Company

Address

Tel:



there are
transformers and
Drake Transformers

A wide range of transformers
manufactured in production
quantities to customers' own
requirements; prompt design
and prototype service.

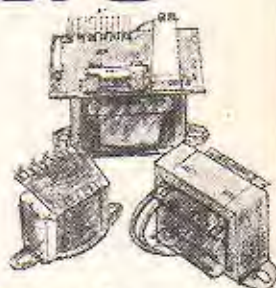

Drake Transformers Limited

South Green Works, Kennel Lane, Billericay, Essex CM11 2SP
Telephone: Billericay 51155. Telex: 99426

WW-048 FOR FURTHER DETAILS

KGM TV CAMERAS

the big choice



Type 130 is a compact 2/3 inch camera with an unusually high specification for a camera of this size. It is a sturdy, reliable camera of great versatility.

Type 113 is an extremely rugged camera designed for critical applications of a very wide nature. Resolution is better than 800 lines.

Type 118 is a day and night camera based on Type 113 but with many unique features to enhance its performance in difficult light conditions.

KGM cameras and monitors are backed by KGM's many years' experience of designing and building CCTV equipment for large industrial users and leading public authorities. *Send for your data sheets now.*

KGM ELECTRONICS
LIMITED

Clock Tower Road, Isleworth, Middlesex TW7 6DU
Tel: 01-568 0151. Telex: 934120

WW-008 FOR FURTHER DETAILS

WHY SETTLE FOR LESS— THAN A 6800 SYSTEM

MEMORY—

All static memory with selected 2102 IC's allows processor to run at its maximum speed at all times. No refresh system is needed and no time is lost in memory refresh cycles. Each board holds 4,096 words of this proven reliable and trouble free memory. Cost—only £80.00 for each full 4K memory.

INTERFACE—

Serial control interface connects to any RS-232, or 20 Ma. TTY control terminal. Connectors provided for expansion of up to eight interfaces. Unique programmable interface circuits allow you to match the interface to almost any possible combination of polarity and control signal arrangements. Baud rate selection can be made on each individual interface. All this at a sensible cost of only £30.00 for either serial, or parallel type

PROCESSOR—

"Motorola" M6800 processor with Mikbug[®] ROM operating system. Automatic reset and loading, plus full compatibility with Motorola evaluation set software. Crystal controlled oscillator provides the clock signal for the processor and is divided down by the MC14411 to provide the various Baud rate outputs for the interface circuits. Full buffering on all data and address busses insures "glitch" free operation with full expansion of memory and interfaces.

POWER SUPPLY—

Heavy duty 10.0 Amp power supply capable of powering a fully expanded system of memory and interface boards. Note 25 Amp rectifier bridge and 91,000 mfd computer grade filter capacitor.

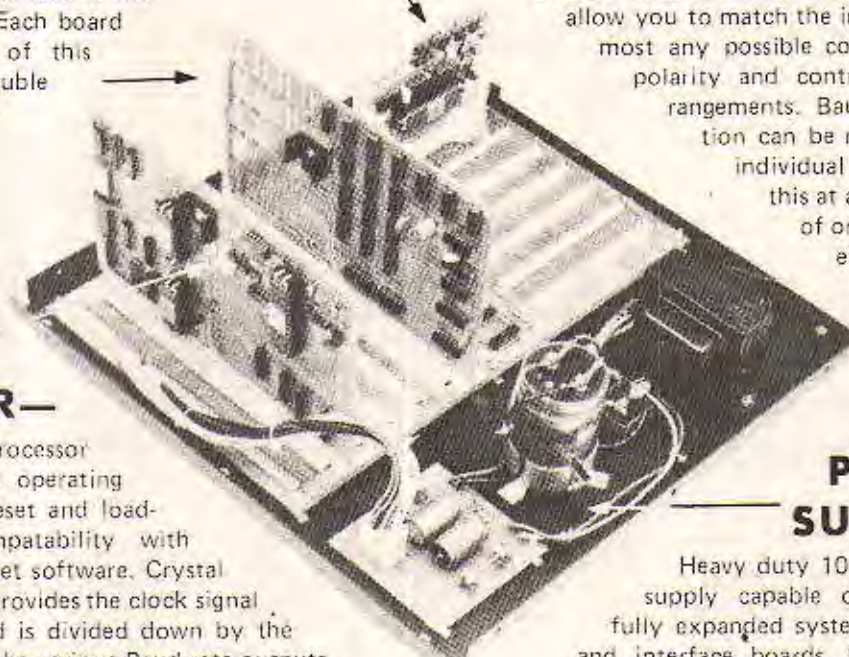

DOCUMENTATION—

Probably the most extensive and complete set of data available for any microprocessor system is supplied with our 6800 computer. This includes the Motorola programming manual, our own very complete assembly instructions, plus a notebook full of information that we have compiled on the system hardware and programming. This includes diagnostic programs, sample programs and even a Tic Tac Toe listing.

Mikbug[®] is a registered trademark of Motorola Inc.

SWT 6800
Computer System

with serial interface and 4,096 words of memory. **£275.00**
(Kit form only)

PRICE EFFECTIVE 1st OCTOBER, 1977



Prices quoted do not include VAT

Please send me details of your full range of computer equipment and software.

Name

Address

.....

.....

Southwest Technical Products Co.
174 Ifield Road, London, SW10

Total Capability in soldering

LITESOLD

PYROMETER Inexpensive check on soldering temperatures



13



TOOLS Hand tools and production aids for electronics

PC/2 SYSTEM Variable power electronic control at economic cost



Send **TODAY** for **FREE** Catalogue with full details of this and other equipment



MINIATURE SOLDERING IRONS
Some of the world's smallest irons, mains and low voltage



SOLDERING IRONS
Comprehensive range of low cost irons 10w to 75w

LIGHT SOLDERING DEVELOPMENTS LTD

97-99 Gloucester Road, Croydon, Surrey CR0 2DN Telephone 01-689 0574, Telex 8811945

WW - 046 FOR FURTHER DETAILS

A. D. BAYLISS & SON LTD.

Behind this name there's a lot of real POWER!

Illustrated right is a **TITAN DRILL**

Mounted in a multi-purpose stand. This drill is a powerful tool running on 12v DC at approx. 9000 rpm with a torque of 350 gm. cm. Chuck capacity 3.00 mm.

The multi-purpose stand is robustly constructed of steel and aluminium. The base and bracket are finished in hammer blue.

Also available for use in the stand is the **RELIANT DRILL** which is a smaller version of the Titan. Approx. speed 9000 rpm, 12v DC, torque 35 gm. cm. Capacity 2.4 mm.

TITAN DRILL & STAND

£19.50

+ 8% VAT = £21.06 + £1 P&P

TITAN DRILL ONLY

£8.90 + 8% VAT = £9.61 + 35p P&P

RELIANT DRILL & STAND

£16.27

+ 8% VAT = £17.52 + £1 P&P

RELIANT DRILL ONLY

£5.22 + 8% VAT = £5.64 + 35p P&P

TITAN MINI KIT DRILL

£14.75

+ 8% VAT = £15.93 + 50p P&P

Plus 20 Tools

RELIANT MINI KIT DRILL

£12.00

+ 8% VAT = £13.08 + 50p P&P

Plus 20 Tools

TRANSFORMER UNIT

£8.55

+ 8% VAT = £9.23 + 75p P&P

These are examples of the extensive range of power tools designed to meet the needs of development engineers, laboratory workers, model makers and others requiring small precision production aids.

To back up the power tools, Expo offer a comprehensive selection of Drills, Grinding Points and other tools.

SEND STAMP for full details to main distributors

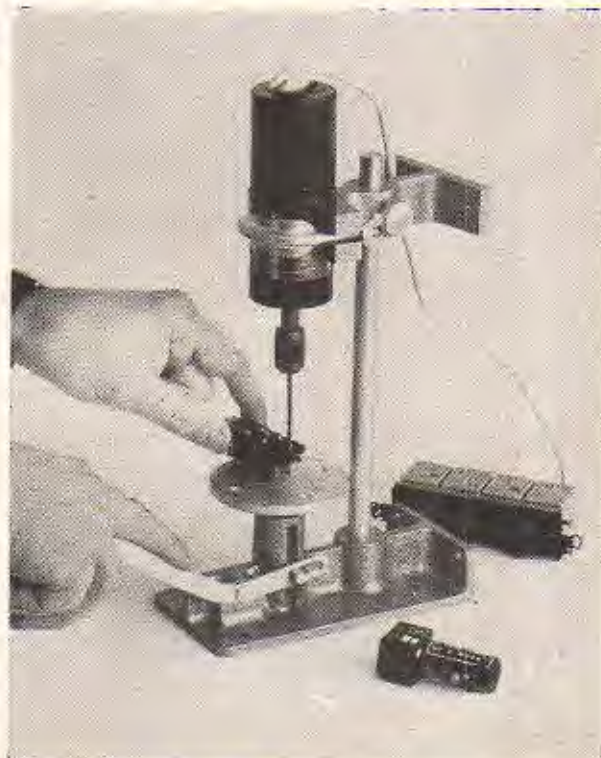

A. D. BAYLISS & SON LTD., Pfera Works, Redmarley, Glos. GL19 3JU

Stockists: Richards Electric, Worcester and Gloucester; Hoopers of Ledbury; Hobbs of Ledbury; D&D Models, Hereford; Bertella, Gloucester

WW-022 FOR FURTHER DETAILS

Stay ahead-follow this sign

GOULD ADVANCE INSTRUMENTS HAVE A WORLDWIDE REPUTATION. BUT THEY NEED NOT COST YOU THE EARTH.



OS245A AND OS250B OSCILLOSCOPES

Two dual trace oscilloscopes, with sensitivity of 5mV/div., and 2mV/cm respectively. The OS250B offers variable trigger level with or without bright line. The OS245A has a bandwidth of 10MHz, the OS250B offers 15MHz. Fully portable, these are the ideal instruments for servicing, educational and general purpose applications.

ALPHA III DIGITAL MULTIMETER

A tough, attractive, 3½ digit multimeter with 25 ranges and a basic accuracy of $\pm 0.2\%$. A bright red LED display gives a clear reading even in high ambient light conditions, and yet power consumption is low enough for extensive field applications.

A purpose built CMOS chip incorporates all analogue and digital circuitry, giving a low component count and increased reliability.



TC 320 TIMER COUNTER

This new, tough, 5-digit unit has an operating frequency of 35MHz. Plated through hole PCB construction keeps the component count down, for exceptional reliability. Frequency measurements up to at least 35MHz can be easily read from the clear 7-segment display. The TC320 offers outstanding performance – including "disciplined" triggering – at a remarkably modest price.

BETA DIGITAL MULTIMETER

A general-purpose multimeter, offering 29 ranges, including temperature (optional), and a basic accuracy figure of $\pm 0.2\%$. A clear, 3½ digit Liquid Crystal Display, 0.5" high, gives a high-contrast read-out. Fully portable, with a minimum of 300 hours' battery life, the Beta has already established a reputation for accuracy and reliability.

For details of any of these instruments and the Gould Advance 2 year guarantee, write or phone today. **Gould Advance Ltd.**, Instruments Division, Roebuck Road, Hainault, Essex IG6 3UE. Telephone: 01-500 1000 Telex: 263785.



GOULD



INSIST ON VERSATOWER

**BY PROFESSIONALS—
FOR PROFESSIONALS**

Designed for Wind Speeds from 85 m.p.h. to 117 m.p.h., conforming with CP3 Chapter V, part II.

First in the field with a fully interchangeable (versatile) telescopic, tilt over, tower system. Acclaimed as the world leader in the field of communications and lighting, both static and mobile.

Since the launching of the Versatower system early in 1968 we have operated a continuous development and applications programme. Consequently from inception right through to the present day, detail design, materials used and production techniques employed are continually updated. This coupled with our quality assurance scheme ensures that we maintain the leader position we enjoy today.

With many thousands of satisfied users throughout the world, coupled with our no nonsense guarantee and immediate spares availability, it makes little sense to settle for an alternative product.



STRUMECH
VERSATOWER
SYSTEM

WW-039 FOR FURTHER DETAILS

ELECTRONIC INDUSTRIAL THERMOMETER



THE MODERN WAY TO MEASURE TEMPERATURE

A Thermometer designed to operate as an Electronic Test Meter. Will measure temperature of Air, Metals, Liquids, Machinery, etc., etc. Just plug-in the Probe, and read the temperature on the large open scale meter. Supplied with carrying case, Probe and internal 1½ volt standard size battery.

Model "Mini-Z 1" measures from -40° C to + 70° C. Price £25.00
Model "Mini-Z 2" measures from -5° C to + 105° C. Price £25.00
Model "Mini-Z Hi" measures from + 100° C to + 500° C. £27.50
(VAT 8% EXTRA)

Write for further details to

HARRIS ELECTRONICS (LONDON)
138 GRAY'S INN ROAD, LONDON, WC1X 8AX
(Phone 01-837 7937)

WW-028 FOR FURTHER DETAILS

Get your copy of the Proline Professional tape recorder leaflet.



Written by professionals only for the professional, the leaflet gives full information on a range of recorders, noted for their

SOPHISTICATION WITHOUT COMPLICATION

Fill in the reader enquiry card or write to:
TONY COSTELLO OR JOHN ROBINSON
LEEVERS-RICH EQUIPMENT LTD
319 TRINITY ROAD LONDON SW18 3SL
01-874 9054

WW-033 FOR FURTHER DETAILS

FAST RESPONSE STRIP CHART RECORDERS

Made in USSR

Series H3020



Basic error: 2.5%
Sensitivity: 8mA F.S.D.
Response: 0.2 sec.
Width of each channel:
Single and three-pen
recorders: 80mm
Five-pen recorders: 50mm

Chart speeds, selected by push buttons: 0.1-0.2-0.5-1.0-2.5-5.0-12.5-25 mm/sec.

Chart drive: 200-250V 50Hz

Recording: Syphon pen directly attached to moving coil frames. Curvilinear co-ordinates.

Equipment: Marker pen, timer pen, paper footage indicator, 10 rolls of paper, connectors, etc.

H3020-1 (Single pen): 285mm wide x 384mm deep x 165mm high

PRICE £108.00

H3020-3 (Three pen): 475mm wide x 384mm deep x 165mm high

PRICE £160.00

H3020-5 (Five pen): 475mm wide x 384mm deep x 185mm high

PRICE £295.00

Series H327



Polarized moving iron movements with syphon pens directly attached. Built-in solid state amplifier (one per channel) provides 8 calibrated sensitivity steps. Two marker pens are provided. Basic error 4%. Frequency response from DC to 100Hz 2dB.

Sensitivity: 0.02 - 0.05 - 0.1 - 0.2 - 0.5 - 1 - 2 - 5 volts/cm

Width of each recording channel: 40mm

Chart drive: 220-250V 50Hz

Chart speeds: 1-2.5-10-50-125-250mm/sec

Type H3271-1. Single pen: Dimensions: 259 x 384 x 165mm

Weight 15 kilos

PRICE £265.00

Type H327-3. Three pen: Dimensions: 335 x 384 x 165mm

Weight 20 kilos

PRICE £520.00

Type H327-5. Five pen: Dimensions: 425 x 385 x 165mm.

Weight 25 kilos

PRICE £770.00.

Note: Prices are exclusive of VAT

Available for immediate delivery

Z & I AERO SERVICES LTD.

44A WESTBOURNE GROVE, LONDON W2 5SF

Tel. 01-727 5641

Telex: 261306

WW-056 FOR FURTHER DETAILS

VERO

For the Professional Amateur

Vero can offer a complete package to help you build your product to a truly professional standard. Full range of veroboards, accessories and housings. Please send 10p plus S.A.E., size 7" x 9" for catalogue.

Vero Electronics Limited. Industrial Estate, Chandler's Ford, Eastleigh, Hampshire, SO5 3ZR.
Telephone: (04215) 2956 Telex 47551 VEROEL G.
Available worldwide through 3 subsidiary Companies and 25 Agents.

WW-014 FOR FURTHER DETAILS

the indispensable
BIRD 43



THRULINE® WATTMETER

0.45-2300 MHz / 0.1-10,000 watts

The Standard of the Industry

What more need we say...

Exclusive UK representative

aspen electronics limited

2 KILDARE CLOSE, EASTCOTE, MIDDX. HA4 9UW
TELEPHONE: 01-868 1188 - TELEX 8812727

WW-021 FOR FURTHER DETAILS

HIGH POWER DC-COUPLED AMPLIFIER



- ★ UP TO 500 WATTS RMS FROM ONE CHANNEL
- ★ DC-COUPLED THROUGHOUT
- ★ OPERATES INTO LOADS AS LOW AS 1 OHM
- ★ FULLY PROTECTED AGAINST SHORT CCT, MISMATCH, ETC.
- ★ 3 YEAR WARRANTY ON PARTS AND LABOUR

The DC300A Power Amplifier is the successor to the world famous DC300 which is so widely used in Industrial, and Research applications in this country. It is DC-coupled throughout so providing a power bandwidth from DC to over 20,000Hz. The ability of the DC300A to operate without fuss into totally reactive loads while delivering its full power, and maintaining its faithful reproduction of Pulse or complex waveforms has established the DC300A as the world's leading power amplifier. Each of the two channels will operate into loads as low as 1 ohm, and the amplifier can be rapidly connected as a single ended amplifier providing over 650 watts RMS into a 4 ohms load, and still providing a bandwidth down to DC. Below is a brief specification of the DC300A, but if you require a data sheet, or a demonstration of this fine equipment please let us know.

Power Bandwidth	DC-20kHz @ 150 watts + 1db. - 0db.	Slewing Rate	8 volts per microsecond
Power at clip point (1 chan)	500 watts rms into 2.5 ohms	Load impedance	1 ohm to infinity
Phase Response	+0. - 15 DC to 20kHz. 1 watt @ 0	Input sensitivity	1.75 V for 150 watts into 8Ω
Harmonic Distortion	Below 0.05% DC to 20kHz	Input impedance	10K ohms to 100K ohms
Intermod. Distortion	Below 0.05% 0.01 watt to 150 watts	Protection	Short, mismatch & open cct. protection
Damping Factor	Greater than 200 DC to 1kHz at 8Ω	Power supply	120 256V, 50-400Hz
Hum & Noise (20-20kHz)	At least 110db below 150 watts	Dimensions	19" Rackmount, 7" High, 9½" Deep
Other models in the range: D60 — 60 watts per channel		D150A — 150 watts per channel	

Other models available from 100 watts to 3000 watts



MACINNES LABORATORIES LTD.

MacInnes House, Carlton Park Industrial Estate
Saxmundham, Suffolk IP17 2NL. Tel: (0728) 2262 2615

MACINNES FRANCE

18 Rue Botzaris
Paris 75019, France
Tel: 206-60-80 or 206-83-61

WW—638 FOR FURTHER DETAILS



KONTAKT 60 FOR INACCESSIBLE CONTACTS

—More than just a cleaner.
KONTAKT 60 guarantees perfect cleaning of contacts chemically in accordance with today's technology.

KONTAKT offers the following advantages:

1. Dissolves oxides and sulphides the safe way without attacking contact substances.
 2. Contains carefully selected solvents which do not attack plastics whereas they do dissolve resinified contact greases and dirt.
 3. Contains no silicones.
 4. Contains a light lubricant in order to avoid the contact paths being corroded.
 5. Prevents further oxidation setting in.
 6. Prevents 'creep' currents.
- Because of these outstanding properties Kontakt 60 is one of the best and most popular contact cleansing agents in the world.

Used by major industrial companies

OTHER KONTAKT PRODUCTS ARE:

- | | |
|-----------------------------------|------------------------------------|
| 70 Protective Lacquer. | 80 Special Siliconized Polish. |
| 72 Insulating Spray. | 100 Antistatic Agent for Plastics. |
| 75 Cold Spray for Fault Location. | 101 Dehydration Fluid. |

Write for full details of above complete range of Kontakt products to:

SPECIAL PRODUCTS DISTRIBUTERS LIMITED

81 Piccadilly, London, W1V 0HL. 01-629 9556.

WW—012 FOR FURTHER DETAILS

Four Good Reasons for using Zettler Relays:

Zettler Relays are first class quality. We have about 50 years experience in producing relays. Zettler Relays are readily available. Most are available ex stock Harrow. Zettler Relays are proved in practical applications. Millions are used in our own electronic systems and products. Zettler has the right relay for most applications, e. g.:



Hybrid Relays AZ 1435...1442

with electronic input and contact output:
AZ 1435 Voltage monitor (9...30 V)
AZ 1436 Pick-up retarder (1...30 s)
AZ 1437 Drop-out retarder (1...30 s)
AZ 1438 Pulse time limiter (50...1500 ms)
AZ 1439 Monoflop (50...1500 ms)
AZ 1440 Multiflop (0.1...30 s)
AZ 1441 Flip-flop (24 V + 10% - 15%, approx. 30 mA max.)
AZ 1442 And-gate (input currents 1 mA max.)



Let us help you with your switching problems.

ZETTLER

est. 1877

Zettler UK Division
Brember Road - Harrow, Middx. HA2 8AS - Tel. (01) 422 0061

Zettler offers more than technology

WW—009 FOR FURTHER DETAILS

BIMCONSOLES BIMBOXES BIMBOARDS BIMDRILLS BIMDICATORS

ABS & DIECAST BIMBOXES

5 sizes, in either ABS or Diecast Aluminium
ABS moulded in Orange, Blue, Grey or Black
Diecast Aluminium available in Gray Hammertone
or Natural



All boxes incorporate guides on all sides for holding 1.5mm thick pcb's and stand-off bosses in base for supporting small sub-assemblies etc. Close fitting flanged lids held by screws running into integral brass bushes (ABS) or tapped holes (Diecast).

	ABS	Diecast	Hammertone	Natural	
(100x50x25mm)	BIM2002/12	£0.95*	BIM5002/12	£1.20*	£0.97*
(112x62x31mm)	BIM2003/13	£1.05*	BIM5003/13	£1.50*	£1.20*
(120x65x40mm)	BIM2004/14	£1.15*	BIM5004/14	£1.86*	£1.49*
(150x80x50mm)	BIM2005/15	£1.30*	BIM5005/15	£2.38*	£1.91*
(190x110x60mm)	BIM2006/16	£2.04*	BIM5006/16	£3.41*	£2.85*

Also available in Gray Polystyrene (112x61x31mm) with no slots and self tapping screws BIM2007/17 £0.88*

MINI DESK BIMCONSOLES

Moulded in Orange, Blue, Black or Grey ABS and incorporating guides on all sides for holding 1.5mm thick pcb's. 1mm Grey Aluminium panel sits recessed into front of console and held by screws running into integral brass bushes. Stand-off bosses in base for supporting small sub-assemblies etc. 4 self adhesive rubber feet also included.

BIM1005
(161x96x58mm)
£2.12*
BIM1006
(215x130x75mm)
£2.94*



LOW PROFILE BIMCONSOLES

1mm Grey Aluminium panel sits recessed into front of console base, which is moulded in Orange, Blue, Black or Grey ABS and sits on 4 self adhesive rubber feet. Incorporating guides for holding 1.5mm thick pcb, the base also has stand-off bosses for supporting small sub-assemblies etc. and ventilation slots. Front panel is held by 4 screws which run into integral brass bushes.

BIM6005 (143x105x55.5 [31.5] mm) £2.32*
BIM6006 (143x170x55.5 [31.5] mm) £3.08*
BIM6007 (214x170x82 [31.5] mm) £4.12*



MULTI-PURPOSE BIMBOXES

Moulded in Orange, Blue, Black or Grey ABS with 1mm thick Grey aluminium recessed front cover which is retained by 4 screws running into integral brass bushes. 1.5mm pcb guides are incorporated on all sides and as with all ABS boxes they are 85°C rated, 4 self adhesive rubber feet also included.

BIM 4003 (85x56x28.5mm) £1.24*
BIM 4004 (111x71x41.5mm) £1.56*
BIM 4005 (161x96x52.5mm) £2.08*

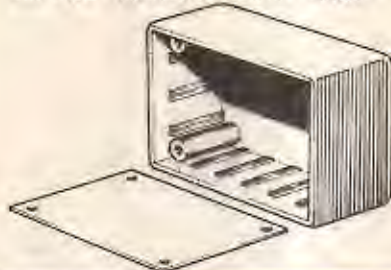

All aluminium, 2 piece desk consoles with either 15° or 30° sloping fronts, sit on 4 self-adhesive non slip rubber feet. Ventilation slots in base and rear panels permit efficient cooling.

Colour Code	Top Panel	Base
A	Off White	Blue
B	Sand	Green
C	Satin Black	Gold

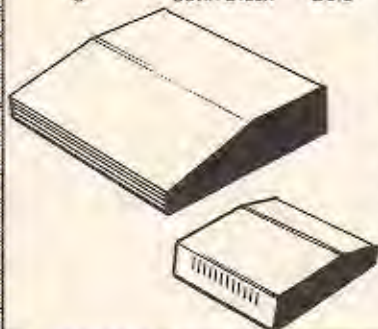

15° Sloping Panel	
BIM7151 (102x140x51 [28] mm)	£ 9.43*
BIM7152 (165x140x51 [28] mm)	£10.43*
BIM7153 (165x216x51 [28] mm)	£11.42*
BIM7154 (165x211x76 [33] mm)	£12.39*
BIM7155 (254x211x76 [33] mm)	£13.66*
BIM7156 (254x287x76 [33] mm)	£14.65*
BIM7157 (356x211x76 [33] mm)	£15.80*
BIM7158 (356x287x76 [33] mm)	£16.78*

30° Sloping Panel	
BIM7301 (102x140x76 [28] mm)	£ 9.43*
BIM7302 (165x140x76 [28] mm)	£10.43*
BIM7303 (165x183x102 [25] mm)	£11.42*
BIM7304 (254x140x76 [29] mm)	£12.39*
BIM7305 (254x183x102 [28] mm)	£13.66*
BIM7306 (254x259x102 [28] mm)	£14.65*
BIM7307 (356x183x102 [28] mm)	£15.80*
BIM7308 (356x259x102 [28] mm)	£16.78*

MAINS BIMDRILL

Operates directly from 220-240Vac and supplied with 2 metres long cable fitted with 2 pin DIN plug. Will drill brass, steel and aluminium as well as pcb's etc. Has integral biased-off switch and accepts tools with 1,2 and 3.2mm dia shanks £9.72*

Accessory Kit including 1mm, 2mm, .125" twist drills, 5 burs and 2.4mm collet £2.20*



12 VOLT BIMDRILLS

2 small but powerful 12V dc drills, easily held in hand or used with lathe/stand adaptor. Both drills have integral on/off switches and 1 metre long cable.

Mini Bimdrill with 2 collets up to 2.4mm capacity £7.58*

Major Bimdrill with 3 collets up to 3mm capacity £12.96*

Mains to 12 Volts adaptor, lathe, stand and accessory kits also available, details on request.



DIL COMPATIBLE BIMBOARDS

Bimboards accept all sizes of DIL packages as well as resistors, diodes, capacitors and LED's etc. They have integral Bus Strips running up each side for carrying Vcc and ground as well as Component Support Brackets for holding lamps, fuses and switches etc. Available as either single or multiple units, the latter mounted on 1.5mm thick, matt black aluminium back plates which stand on non slip rubber feet and have 4 screw terminals for incoming power.

Bimboard 1 contains 500 individual sockets whereas the multiple units containing 2, 3 or 4 Bimboards incorporate 1,100, 1,650 or 2,200 individual sockets, all arranged on a 2.5mm (0.1") matrix.

Bimboard 1 £ 9.72* Bimboard 2 £22.68*
Bimboard 3 £32.40* Bimboard 4 £42.12*



BIMDICATORS



Remember we are also one of Europe's largest manufacturers of Filament, Neon and LED indicators. Send for our BIMINDICATOR DATA

BOSS

INDUSTRIAL MOULDINGS LIMITED

2 Herne Hill Road, London SE24 0AU

Telephone: 01-737 2383

Telex: 919693 Answer Back 'LITZEN G'

Cables & Telegrams: 'LITZEN LONDON SE24'

*All quoted prices are 1 off and include Postage, Packing and VAT. Terms are strictly cash with order unless you have authorised BOSS account. For individual data sheets on all BOSS products send stamped, self addressed envelope

15 — 240 Watts!

HY5 Preamplifier

The HY5 is a mono hybrid amplifier ideally suited for all applications. All common input functions (mag Cartridge, tuner, etc.) are catered for internally, the desired function is achieved either by a multi-way switch or direct connection to the appropriate pins. The internal volume and tone circuits merely require connecting to external potentiometers (not included). The HY5 is compatible with all I.L.P. power amplifiers and power supplies. To ease construction and mounting a P.C. connector is supplied with each pre-amplifier.

FEATURES: Complete pre-amplifier in single pack — Multi-function equalization — Low noise — Low distortion — High overload — two simply combined for stereo

APPLICATIONS: Hi-Fi — Mixers — Disco — Guitar and Organ — Public address

SPECIFICATIONS:

INPUTS: Magnetic Pickup 3mV, Ceramic Pickup 30mV, Tuner 100mV, Microphone 10mV, Auxiliary 3-100mV, input impedance 47k Ω at 1kHz

OUTPUTS: Tape 100mV, Main output 500mV R.M.S.

ACTIVE TONE CONTROLS: Treble \pm 12dB at 10kHz, Bass \pm at 100Hz

DISTORTION: 0.1% at 1kHz, Signal/Noise Ratio 58dB

OVERLOAD: 38dB on Magnetic Pickup, SUPPLY VOLTAGE \pm 16.50V

Price £5.22 + 65p VAT P&P free

HY5 mounting board BT 48p + 8p VAT P&P free.



HY30 15 Watts into 8 Ω

The HY30 is an exciting New kit from I.L.P. It features a virtually indestructible I.C. with short circuit and thermal protection. The kit consists of 1 I.C., heatsink, P.C. board, 4 resistors, 5 capacitors, mounting kit, together with easy to follow construction and operating instructions. This amplifier is ideally suited to the beginner in audio who wishes to use the most up-to-date technology available.

FEATURES: Complete kit — Low Distortion — Short, Open and Thermal Protection — Easy to Build, Application: Updating audio equipment — Guitar practice amplifier — Test amplifier — Audio oscillator.

SPECIFICATIONS:

OUTPUT POWER: 15W R.M.S. into 8 Ω , **DISTORTION:** 0.1% at 15W.

INPUT SENSITIVITY: 500mV, **FREQUENCY RESPONSE:** 10Hz-16kHz — 3dB

SUPPLY VOLTAGE: \pm 18V.

Price £5.22 + 65p VAT P&P free.



HY50 25 Watts into 8 Ω

The HY50 loads I.L.P.'s total integration approach to power amplifier design. The amplifier features an integral heatsink together with the simplicity of no external components. During the past three years the amplifier has been refined to the extent that it must be one of the most reliable and robust High Fidelity modules in the World.

FEATURES: Low Distortion — Integral Heatsink — Only five connections — 7 Amp output transistors — No external components.

APPLICATIONS: Medium Power Hi-Fi systems — Low power disco — Guitar amplifier.

SPECIFICATIONS: INPUT SENSITIVITY 500mV

OUTPUT POWER: 25W RMS in 8 Ω , **LOAD IMPEDANCE:** 4-16 Ω , **DISTORTION:** 0.04% at 25W at 1kHz.

SIGNAL/NOISE RATIO: 75dB, **FREQUENCY RESPONSE:** 10Hz-45kHz — 3dB.

SUPPLY VOLTAGE: \pm 25V, **SIZE:** 105.50 x 25mm.

Price £6.82 + 85p VAT P&P free



HY120 60 Watts into 8 Ω

The HY120 is the baby of I.L.P.'s new high power range, designed to meet the most exacting requirements including load line and thermal protection, this amplifier sets a new standard in modular design.

FEATURES: Very low distortion — Integral Heatsink — Load line protection — Thermal protection — Five connections — No external components.

APPLICATIONS: Hi-Fi — High quality disco — Public address — Monitor amplifier — Guitar and organ.

SPECIFICATIONS:

INPUT SENSITIVITY: 500mV

OUTPUT POWER: 60W RMS into 8 Ω , **LOAD IMPEDANCE:** 4-16 Ω , **DISTORTION:** 0.04% at 60W at 1kHz.

SIGNAL/NOISE RATIO: 90dB, **FREQUENCY RESPONSE:** 10Hz-45kHz — 3dB, **SUPPLY VOLTAGE:** \pm 35V.

Size: 114 x 50 x 85mm.

Price £15.84 + £1.27 VAT P&P free.



HY200 120 Watts into 8 Ω

The HY200, now improved to give an output of 120 Watts, has been designed to stand the most rugged conditions, such as disco or group while still retaining true Hi-Fi performance.

FEATURES: Thermal shutdown — Very low distortion — Loadline protection — Integral Heatsink — No external components.

APPLICATIONS: Hi-Fi — Disco — Monitor — Power Slave — Industrial — Public address.

SPECIFICATIONS:

INPUT SENSITIVITY: 500mV.

OUTPUT POWER: 120W RMS into 8 Ω , **LOAD IMPEDANCE:** 4-16 Ω , **DISTORTION:** 0.05% at 100W at 1kHz.

SIGNAL/NOISE RATIO: 96dB, **FREQUENCY RESPONSE:** 10Hz-45kHz — 3dB, **SUPPLY VOLTAGE:** \pm 45V.

SIZE: 114 x 100 x 85mm.

Price £23.32 + £1.87 VAT P&P free.

HY400 240 Watts into 4 Ω

The HY400 is I.L.P.'s "Big Daddy" of the range producing 240W into 4 Ω . It has been designed for high power disco or public address applications. If the amplifier is to be used at continuous high power levels a cooling fan is recommended. The amplifier includes all the qualities of the rest of the family to lead the market as a true high power hi-fidelity power module.

FEATURES: Thermal shutdown — Very low distortion — Load line protection — No external components.

APPLICATIONS: Public address — Disco — Power slave — Industrial.

SPECIFICATIONS:

OUTPUT POWER: 240W RMS into 4 Ω , **LOAD IMPEDANCE:** 4-16 Ω , **DISTORTION:** 0.1% at 240W at 1kHz.

SIGNAL/NOISE RATIO: 94dB, **FREQUENCY RESPONSE:** 10Hz-45kHz — 3dB, **SUPPLY VOLTAGE:** \pm 45V.

INPUT SENSITIVITY: 500mV, **SIZE:** 114 x 100 x 85mm.

Price £32.17 + £2.57 VAT P&P free.



POWER SUPPLIES

PSU38 suitable for two HY30's **£5.22** plus 65p VAT P&P free.

PSU50 suitable for two HY50's **£6.82** plus 85p VAT P&P free.

PSU 70 suitable for 2 HY 120's **£19.75** plus £1.10 VAT P&P free.

PSU140 suitable for one HY200 **£12.65** plus £1.01 VAT P&P free.

PSU180 suitable for two HY200's or one HY400 **£29.10** plus £1.88 VAT P&P free.

BT 48p plus 8p VAT.

TWO YEARS' GUARANTEE ON ALL OF OUR PRODUCTS

I.L.P. Electronics Ltd
Crossland House
Nackington, Canterbury
Kent CT4 7AD
Tel (0227) 63218

Please Supply _____
Total Purchase Price _____
I Enclose Cheque Postal Orders Money Order
Please debit my Access account Barclaycard account
Account number _____
Name & Address _____
Signature _____

IF YOU NEED JACKFIELDS WHY NOT TALK TO THE SPECIALISTS?

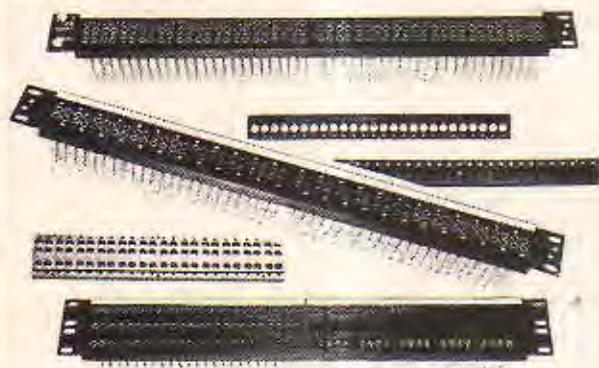

PANELS AND ASSEMBLIES

No supplier offers a wider range of panels, inserts and accessories for just about any configuration. And you can get them in any stage of assembly . . . individual components, sub-assemblies, or complete pre-wired and connectorised assemblies ready to install. Our Bantam range gives a space saving of up to 50 per cent.



JACKS AND PLUGS

Singles . . . twins . . . back-to-back . . . 2+1 . . . patch and switchboard cords . . . in long frame and Bantam . . . and our new Printed Circuit Board Jacks . . . most standard types are available for immediate off-the-shelf delivery.

For further information on these and our range of B.P.O. type components telephone or send the attached below to:

C.A.E. LIMITED

70/82 Akeman Street
Tring, Herts. HP23 6AJ
Tel. (044 242) 4011 Telex: 82362 BATECO G

Please send us copy of current catalogue.

NAME
COMPANY
POSITION
ADDRESS

Tel

Join the Digital Revolution

Understand the latest
developments in calculators,
computers, watches, telephones,
television, automotive instrumentation . . .

Each of the 6 volumes of this self-instruction course measures 11 1/2" x 8 1/4" and contains 60 pages packed with information, diagrams and questions designed to lead you step-by-step through number systems and Boolean algebra, to memories, counters and simple arithmetic circuits, and on to a complete understanding of the design and operation of calculators and computers.

Design of Digital Systems.



£7.10

plus 90p packing and surface post anywhere in the world.

Overseas customers should send for Proforma invoice. Quantity discounts available on request.

VAT zero rated.

Also available — a more elementary course assuming no prior knowledge except simple arithmetic.
Digital Computer Logic and Electronics.

In 4 volumes:

1. Basic Computer Logic
2. Logical Circuit Elements
3. Designing Circuits to Carry Out Logical Functions
4. Flipflops and Registers

£4.60

plus 90p P. & P.

Offer Order both courses for the bargain price £11.10 plus 90p P. & P.
A saving of £1.50.

Designer Manager Enthusiast Scientist Engineer Student

These courses were written so that you could teach yourself the theory and application of digital logic. Learning by self instruction has the advantages of being quicker and more thorough than classroom learning. You work at your own speed and must respond by answering questions on each new piece of information before proceeding to the next.

NEW from Cambridge Learning Enterprises:

FLOW CHARTS & ALGORITHMS £2.95
use, design & layout: vital for computing.
training, wall charts, etc. plus 45p p & p

Guarantee — If you are not entirely satisfied your money will be refunded.

To: Reg. Office: Cambridge Learning Enterprises, Dep COM FREEPOST
Riverside House, St Ives, Huntingdon, Cambs. PE17 4BR
Proprietors: Drayridge Ltd. Registered in England No. 132875

Please send me _____ set(s) of Design of Digital Systems at £8.00 each, p & p included

or _____ set(s) of Digital Computer Logic and Electronics at £5.50 each, p & p included

or _____ (combined set(s)) at £12.00 each, p & p included
or _____ The Algorithms Writer's Guide at £3.40 each, p & p included

Name _____

Address _____

*delete as applicable

No need to use a stamp — just print FREEPOST on the envelope

WW 2

THE **baker** QUALITY



150 watt mixer amplifier

- All purpose Bass, Lead, Rhythm Guitars, Discotheque, Vocal, Public Address, etc.
- Amplifier "Mains switch" for instant sound or muting.
- Three loudspeaker outlets for 4, 8 or 16 ohms operation.
- Four high gain inputs, each 28 mv, 50K ohm for full output.
- Individual volume controls with "Four channel" mixing facilities.
- 150 watts into 8 ohms. R.M.S. Music Power.
- Distortion less than 1% at full output.
- Slave output 500 M.V. 25 K.ohm.
- Accepts loudspeakers from 4 ohms upwards. Standard jack sockets.
- Frequency Response 25 Hz — 20kHz = 3dB integral Hi Fi preamp.
- 32dB Variation on wide range separate Bass & Treble controls.
- Fully Short and Open circuit proof, electronic and fused.
- Compact — 16" x 8" x 5 1/2" approximately.
- Lightweight — Only 14lb. — approximately.
- Blue wording on Black fascia.
- Made in England. 12 months' guarantee. 200/250v A.C. mains or 120V to order.
- All transistor and solid state devices.

Distributors required in certain countries and parts of UK.

Baker Loudspeakers Limited

NEW! Star sound

A high power full range quality loudspeaker produced to give exceptional reproduction. Ideal for electronic guitars, organs, public address or discotheques. This loudspeaker is recommended where high power handling is required with quality results. The high flux ceramic magnet assembly ensures clear treble response so necessary for today's musician.



GROUP 50/12 inch

Voice Coil Impedance	4 or 8 or 16 ohms
Maximum Power	80 watts (120 watts U.S.A.)
Bass Resonance	55 c.p.s.
Useful Response	30-16,000 c.p.s.
Flux Density	15,000 lines
Voice Coil	1 1/2" / 38 mm
Overall diameter	12 1/2" / 310 mm
Overall depth	4 3/4" / 120 mm
Fixing holes diagonal	13" / 330 mm
Baffle aperture	11" / 280 mm
Nett weight	10 lbs / 4.5 kgt

GROUP 25 12 inch

Voice Coil Impedance	4 or 8 or 16 ohms
Maximum Power	30 watts (60 watts U.S.A.)
Bass Resonance	55 c.p.s.
Useful Response	30-13,000 c.p.s.
Flux density	12,000 lines
Voice coil	1 1/2" / 38 mm
Overall diameter	12 1/4" / 310 mm
Overall depth	4 3/4" / 120 mm
Fixing holes diagonal	13" / 330 mm
Baffle aperture	11" / 280 mm
Nett weight	5 lbs. / 2.3 kg.

GROUP 35 12 inch

Voice Coil Impedance	4 or 8 or 16 ohms
Maximum Power	40 watts (80 watts U.S.A.)
Bass Resonance	55 c.p.s.
Useful Response	30-13,000 c.p.s.
Flux Density	14,000 lines
Voice coil	1 1/2" / 38 mm
Overall diameter	12 1/4" / 310 mm
Overall depth	4 3/4" / 120 mm
Fixing holes diagonal	13" / 330 mm
Baffle aperture	11" / 280 mm
Nett weight	6 lbs. / 2.7 kg.

GROUP 50 15 inch

Voice Coil Impedance	8 or 16 ohms
Maximum Power	75 watts (150 watts U.S.A.)
Bass Resonance	45 c.p.s.
Useful Response	30-13,000 c.p.s.
Flux Density	15,000 lines
Voice coil	2" / 51 mm
Overall diameter	15 1/2" / 390 mm
Overall depth	8" / 193 mm
Fixing holes diagonal	16 3/4" / 417 mm
Baffle aperture	11" / 280 mm
Nett weight	15 lbs. / 6.8 kg.

337 Whitehorse Road, Croydon, Surrey, England

Telephone: 01-684 1665

METER PROBLEMS?

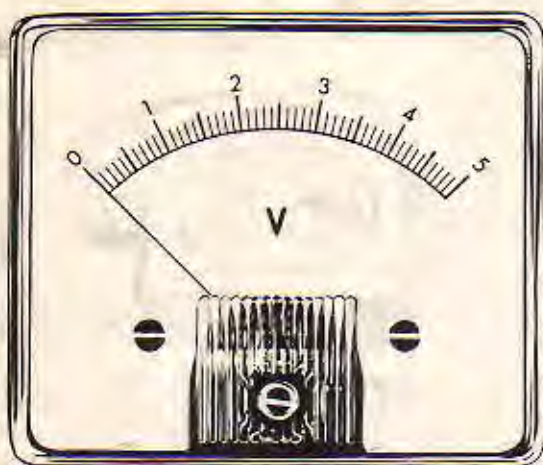

137 Standard Ranges in a variety of sizes and stylings available for 10-14 days delivery. Other Ranges and special scales can be made to order.

Full Information from:

HARRIS ELECTRONICS (London)

138 GRAYS INN ROAD, W.C.1 Phone: 01/837/7937

WW-029 FOR FURTHER DETAILS

New The British Plot



The CR600 and CR700 Chart Recorders have been designed for the discerning user who requires a combination of fast writing speed, high accuracy plus versatility and good looks.

- 1000 mm/sec. writing speed
- 0.05% Linearity
- 0.05% Repeatability
- 0.1% Accuracy
- 0.02 mm/min. — 20 mm/sec. Chart speed

Standard features include: — 18 electronically controlled chart speeds with forward/reverse and remote operation. Chart feed and take up for Z fold or roll chart paper. Two separate channels with full pen overlap, self calibrate stepped range attenuators and span controls, 1000% precisely calibrated zero suppression. Remote operated event marker, pen lift and chart control. Both recorders are suitable for mains or battery operation and may be mounted horizontally or vertically.

Write today for full illustrated specification.

JJ
INSTRUMENTS

J.J. LLOYD INSTRUMENTS LIMITED
Brook Avenue, Warsash, Southampton SO3 6HP,
England. Tel: Locks Heath 4221 (STD 048 95)
Telex: 477042 - JAY JAY - SOTON
Cables Eddymes, Southampton



WW — 050 FOR FURTHER DETAILS



DIGITAL CASSETTE RECORDERS

Low power analogue or digital input data loggers and terminal readers. Cassettes compatible with TI Silent 700, Wang 2200 or ECMA34. Read/write units for data storage or programme load/dump applications up to 32'000 bits/sec. Continuous and incremental transport and complete systems for OEM and end user applications.

WW-064 FOR FURTHER INFORMATION

DATA ACQUISITION SYSTEMS

Modules and cards which plug into NOVA, PDP8, PDP11, LSI11, SBC80 and MDS800 computers, scan 64 analogue channels, includes 12 bit ADC and programme interrupt logic plus analogue outputs. Also, complete intelligent mains powered systems with analogue and digital input/output used for stand alone or front end data acquisition and control.

WW-065 FOR FURTHER INFORMATION

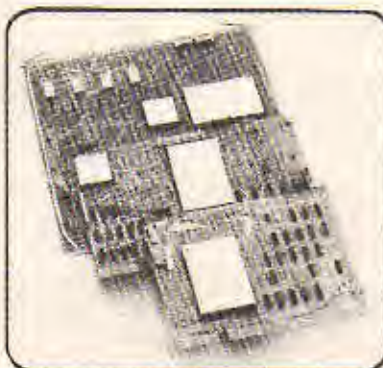

DIGITAL PANEL METERS

Mains or 5VDC powered, scale lengths from 999 to 49999 with resolution down to one microvolt. DIN or NEMA case sizes, 0.5 or 0.8 inch LED, Beckman gas discharge or liquid crystal displays.

WW-066 FOR FURTHER INFORMATION

AMPLICON
AMPLICON ELECTRONICS LTD.,
 Lion Mews, Hove BN3 5RA.
 Tel: Brighton (0273) 720716
 Telex: 87323 Amplicon

**AUDIBLY SUPERIOR
 AMPLIFICATION**

**HIGH DEFINITION — 'MUSICAL' — POWER AMP
 MODULES**

- * T.H.D. TYPICALLY .007%
- @ 10W, 500Hz
- * ZERO T.I.D. (SLEW-RATE LIMIT 16 V/μS)

Module size: 120 x 80 x 25 mm, using glass fibre pcb with idem and solder resist. Illustrated with light duty heatsink.

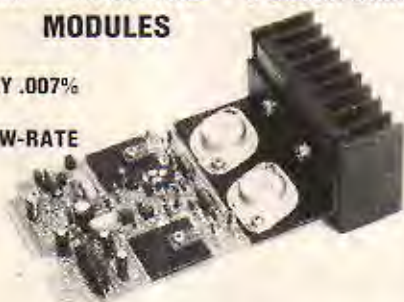

CRIMSON ELEKTRIK power amplifier modules are fast gaining a reputation as the best sounding, most musical modules available. Perhaps the most important features of this design are exceptional freedom from crossover distortion due to the use of output triodes and zero T.I.D. The amplifier is protected against open and short circuit loads and yet will drive a highly reactive, lower impedance load, which is more representative of a real loudspeaker. Square waves maintain their true shape up to full power while simulated electrostatic loads are easily handled, with negligible overshoot and a settling time of 12.5. Other specs: S/N: 110dB, Rise time 10:8, Sensitivity 275mV, DC coupled, 5Hz-35kHz, -30dB, THD: 0.15%, 100mW clipping, 500Hz.

CRIMSON ELEKTRIK power supplies are at all times for maximum flexibility and feature a low loss, wide range transformer with a 120-240v primary and screen, two large capacitors, bridge rectifier and all fittings.

POWER AMP MODULES	HOME	EUROPE
CE 808 50Wms-8 ohms 35v ac	£16.30	£16.30
CE 1004 100Wms-4 ohms 25v ac	£19.22	£19.00
CE 1008 100Wms-8 ohms 45v ac	£23.22	£22.70
POWER SUPPLIES		
CP5 1 For 2x25008 or 1x4F100A	£12.85	£14.20
CP5 2 For 2x251305 or 2 or 4x25008	£14.25	£17.90
CP5 3 For 2x251306	£15.85	£19.20
HEATSINKS		
Light duty 50mm 2 C/W	50	£1.30
High power 100mm 1.4 C/W	£1.80	£2.40
Cluck group 1500mm 1.1 C/W	£2.30	£3.65

**CRIMSON
 ELEKTRIK**
 (WV)
 1A STAMFORD STREET
 LEICESTER
 LE1 6HL
 Tel: (0533) 537722

Home prices include VAT and carriage. Payment by cheque, PO, CDD 60p, £50 limit. Export orders problem. European prices include carriage, insurance and handling, payment in Sterling by bank draft, P.I. International Giro or Money Order. Outside Europe, please refer to our specific quote by return. Special SAE or two International Reply Coupons for full literature. Favourite trade quantity price list on request. Sample price apply from 200.

WW-023 FOR FURTHER DETAILS

NEW LINES

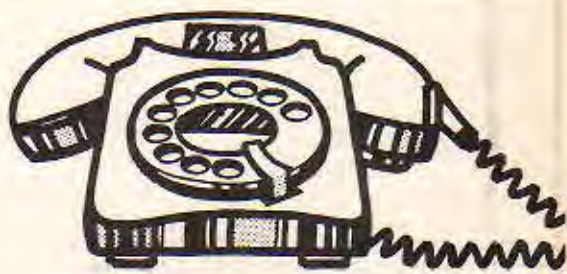

FROM VEROSPEED HOTLINE

- Battery Wire Wrapping Tool ● Standard Toggle Switches
- Sub Min Toggle Switches ● Cyanoacrylate Adhesive
- Nylze Enamelled Wire ● Thumbwheel Switches ● Filament Indicators ● Crystal Oscillators ● Precision Resistors ● P. C. Terminal Blocks ● Keyboard Switches ● Potting Compound
- Rocker Switches ● Neon Indicators ● Cermet Trimmers
- Circuit Lacquer ● Micro Switches ● Epoxy Adhesive ● LED Indicators ● Label Holders ● Foot Switches ● Mini Shears..

AVAILABLE EX STOCK BY RETURN
 For your new catalogue write to:
VEROSPEED, Barton Park Industrial Est., Eastleigh, Hants.
 or phone 0703 618525

WW - 072 FOR FURTHER DETAILS

WE KNOW OF ONLY ONE OTHER POWER AMPLIFIER MODULE SUPERIOR TO OUR

JPS 100 — The JPS 150

For starters, JPS Power Amplifier Modules are designed, manufactured and tested in England, yet sold throughout the world.

Incorporating comprehensive protection circuits including mismatch, short and open circuits, impedance and thermal protection, these Modules will ensure a high standard of both reliability and top performance.

Unlike other models, they offer an indefinite life-span! Should they ever require any attention or repair, all components on both Modules are easily replaceable. And, what's more, they both also carry a full two-year guarantee. That's confidence for you!

Power Output
Frequency Response
Power Bandwidth
Slew Rate
Total Harmonic Distortion
Hum and Noise
Damping Factor
Input Sensitivity
Input Impedance
Power Requirements
Transistor Complement
Module Dimensions
Guarantee

JPS 100 £28.50
110 watts RMS 8 ohms
10-22kHz — 0.05%
10-22kHz — 0.05%
3.4 Volts per microsecond
0.04% @ 1kHz
115dB below 150 watts
Greater than 300 to 1kHz
0dB (0.775 Volts) 100 watts
47k
+ 45 Volts
12 transistors, 1 integrated circuit
4" H x 5" W x 2" D
Full 2 year

JPS 150 £33.30
170 watts RMS 8 ohms
10-22kHz + 0dB — 0.05%
10-22kHz + 0dB — 0.05%
9.00 Volts per microsecond
0.04 @ 1kHz
115dB below 150 watts
Greater than 400 to 1kHz
0dB (0.775 Volts) 150 watts
47k
+ 35 Volts
12 transistors, 1 integrated circuit
6" H x 5" W x 2" D
Full 2 year



* These parameters may be changed to suit particular requirements.
For industrial usage frequency response can be extended DC to 30kHz + 0dB — 0.2dB (150 only)

JPS Associates

BELMONT HOUSE, STEELE ROAD, PARK ROYAL, LONDON NW10 7AR
TELEPHONE 01-961 1274 TELEX: TITTS 916226

POWER SUPPLIES

PS1 Powers 1 JPS 60 price £15.50
PS2 Powers 1 JPS 100
Powers JPS 150
Price £21.50

PS3 powers 2 JPS 150 £31.50

All prices are subject to 6% VAT

All module drive cards are based on industry standard Eurocard system (100 x 150 mm)
A 60 watt version is also available with a similar specification. Price £23.30 + VAT

WW-031 FOR FURTHER DETAILS

ANNOUNCING THE MICROS

JOIN THE MICRO REVOLUTION!

£550 for a Z80 based microcomputer, built and tested



- * Includes CPU, ROM, RAM, TV and Audio cassette interface, UHF modulator, ASCII keyboard, power supplies and cabinet.
- * Connect to domestic TV or video monitor to complete the system.
- * 48 x 16 character video matrix
- * Hard copy on teletype
- * Also available in kit form £470, or 5 kitpacks at £95 each
- * Designed for educational establishments, personal computing and small business users
- * Load and dump programmes on unmodified cassette recorder
- * 57 key contactless ASCII keyboard
- * British designed and built
- * Credit terms available

THE MICRONICS COMPANY

1, STATION ROAD TWICKENHAM MIDDLESEX

PART OF THE MICRO REVOLUTION

Prices exclusive of VAT and carriage

WW-052 FOR FURTHER DETAILS

**QUARTZ
CRYSTALS
— FAST!**



AEL

AEL CRYSTALS LIMITED
Dewick House, Horley, Surrey, England RH6 6SU
Telephone: Horley (02934) 5353 Telex: 87116 (Aerocon Horley)
Cable: Aerocon Telex Horley

WW-019 FOR FURTHER DETAILS

JES AUDIO INSTRUMENTATION



Illustrated the Si452
Distortion Measuring
Unit—low cost distortion
measurement down to
.01% £48.00

Si451 £60.00 Si453 £60.00
Comprehensive Millivoltmeter Low distortion Oscillator
350µ Volts 20 ranges sine — square — RIAA

prices plus VAT

J. E. SUGDEN & CO. LTD. Tel. Cleckheaton (0274) 872501
CARR STREET, CLECKHEATON, W. YORKSHIRE B19 5LA

WW-042 FOR FURTHER DETAILS

TRUE PROFESSIONALS

Including: EMI, Decca (UK), BBC, Pink Floyd, Hawker Sidley, Metropolitan Police, The Who, Queen, Thames TV, ITN, Capital Radio, Decca (France), Ministry of Defence, Birds Eye, Rolls Royce, Crown Agents, Madame Tussaud's, Island Music, Chappells, Dick James Music, Neve, Alice, Israel Defence Ministry, Yes Music, University of Bucharest, Pye TVT, Avon Health Authority, Government of Seychelles, Philippines Radio, London Broadcasting, Rolling Stones, Thin Lizzie, British Railways, Natural History Museum, Virgin Records, Kirilo Savic Institute of Belgrade, all British Universities, London Weekend TV, BOC, Wings, IBM, every Local Radio Station, Post Office Research, Rank Organisation, and many others.

ACKNOWLEDGE

That ITA has more to offer:

- **Location.** In Central London — easy parking.
- **Delivery.** Large stockholding covering 500 versions for immediate delivery.
- **Servicing** by ITA factory trained staff. Quickest turnaround time. Machines supplied or rebuilt for special requirements.
- **Pricing.** Check our prices — you will find them lowest ALWAYS.

ITA'S ADVANTAGES

1-7 Harewood Avenue, Marylebone Road, London NW1. Tel: 01-724 2497.
Telex: 21879.

WW-081 FOR FURTHER DETAILS



REVOX

A wide range of two channel recorders from this famous manufacturer, with tape speeds from 15/16 ips to 30 ips. Options include variable speed and sel-sync. Models include A77, B77 and 377 with 3 speeds and editing (designed and modified by ITA specifically for professional applications).



TEAC

Recorders for logging and studio use — tape speeds from 1 1/2 to 15 ips, 2, 4 or 8 channel. A range of mixers is also available.



ITAM

4 and 8 channel recorders for studio use. Any tape speed from 1 1/2 ips for logging and data recording.



OTARI

Duplicating equipment for high speed cassette copying, including the DP4050 model — the world's finest in-cassette copier, with 6 slave units.

ITA

At the end of the test session the communications engineer sang the praises of our filters.

"What performance" he said, referring to the capability of the Barr & Stroud EF3 Filter System in satisfying his signal conditioning needs. He and other engineers in many fields are equally complimentary about our supporting range of Active Filter Modules and our Custom-Built Filter Service.

We have fully descriptive literature which will generate similar enthusiasm in yourself. Use the journal reply system or call us, Barr & Stroud Limited, 1 Pall Mall East, London SW1Y 5AU (Dept. WW/1). Telephone 01-930 1541. Telex 261877.

EF3 Variable Filter System

Designed on a modular basis to give flexibility in use and to match your budget. A plug-in system developed for use in labs., test departments, anywhere where signal conditioning is required.

Filter units can be used separately or combined to give a wide variety of functions from low-pass to band-separate.

The current pass-band capacity is from d.c. to 10 MHz.

Active Filter Modules

The ready-to-use convenience of small, encapsulated filter units, each with a basic function.

No filter knowledge required to set up for specific characteristic or cut-off frequency. These filters are equally suited to the one-off lab. application and the large quantity production requirement.

Available in low-pass, high-pass, universal and notch designs with a range of cut-off frequencies and attenuation rates.

Custom-Built Filters

The basis of our filter activity, this service has for 20 years provided solutions to customers specific requirements. Based on in-house computer facilities and an extensive programme library we can design and manufacture the filters not provided in our standard range.

Designs can be passive or active with cut-off rates up to several hundred dB per octave in a frequency range up to around 70 MHz.



Barr & Stroud

Add us to your resources

ELECTRONIC FILTERS, OPTICAL FILTERS, FIBRE OPTICS, LASERS, SCIENTIFIC AND MEDICAL INSTRUMENTATION.

wireless world

Viewdata needs encouragement

Editor:

TOM IVALL, M.I.E.R.E.

Deputy Editor:

 PHILIP DARRINGTON
 Phone 01-261 8435

Technical Editor:

 GEOFFREY SHORTER, B.Sc.
 Phone 01-261 8443

Projects Editor:

 MIKE SAGIN
 Phone: 01-261 8429

Communications Editor:

 RAY ASHMORE, B.Sc., G8KYY
 Phone 01-261 8043

News Editor:

 JOHN DWYER
 Phone 01-261 8620

Production:

D. R. BRAY

Advertisement Controller:

G. BENTON ROWELL

Advertisement Manager:

 BOB NIBBS
 Phone 01-261 8622

CHRIS PRIER

Phone 01-261 8037

Classified Manager:

 BRIAN DURRANT
 Phone 01-261 8508 or 01-261 8423

 EDDIE FARRELL (*Classified Advertisements*)
 Phone 01-261 8508

 JOHN GIBBON (*Make-up and copy*)
 Phone 01-261 8353

Publishing Director:

GORDON HENDERSON

DURING THE coming months Viewdata, the Post Office's experimental information system, will be undergoing market trials, and by this time next year we may be getting some idea of the extent and nature of the demand for such a service. One thing is certain. There's no use in waiting hopefully for as yet unknown applications to reveal themselves magically like buds responding to the sun. Viewdata is a new type of service and it has got to be sold. From an engineering and economic point of view it is obviously a good system, giving greater utilisation of the existing public telephone network by means of established television and computer technology, but this alone will not impress the man who has to pay the bill. It will be a great pity if Viewdata does not attract sufficient demand to make it a commercial success. If the Post Office is left in sole charge of it there is a strong chance it will not.

This is not to criticize the able Post Office executives who have the marketing job to do, but the nature of the organization itself. The Post Office is a public corporation that is also a monopoly. However great its capital resources, however competent its engineering and skilful its marketing, it will always lack one vital element — an awareness of the possibility of failure. By definition it cannot fail because, whatever it does, there is no other comparable organization against which to measure its performance (cf. the BBC before the arrival of independent broadcasting). In principle it is accountable to the public, but this only means explaining aloofly what profits or losses are made on the basis of charges it fixes for itself. In the event of losses the people concerned are unlikely to lose their jobs or

reputations or suffer a reduction of income.

Last year the National Association of Radio Communication Services issued a manifesto declaring that the Post Office should not monopolise the very services that stimulate the use of the telecommunications network if these services can be provided as cheaply and as efficiently by private industry. It listed nine areas of activity and services including Viewdata, car radiotelephones, radio paging, facsimile and conference television, and claimed that private companies could have provided some of them far earlier than the Post Office has and at competitive prices. It also asserted that the monopoly "has been self defeating in that the Post Office has lost revenue from the lack of expansion of these services."

There is much good sense in these claims, even if some of the facts are in dispute, and NARCS's call for an Act of Parliament to remove the Post Office's monopoly powers deserves the support of everyone who wants to see our communication services developed fully and effectively. As for Viewdata in particular, there is no reason why such a service should not be run by competing private operators using the Post Office network and with nationally agreed technical standards but with their own data bases, computers, software and competing types of service. At such an early stage it is still not too late for the Government to allow at least an experiment with private operation, without necessarily affecting the Post Office's monopoly in any formal sense. If the experiment failed the losses would be borne by private investors, who are prepared for financial risks, and not by the taxpayer.

A basic radio telescope

Portable two aerial system for detecting the sun, milky way, and sources beyond the solar system.

by J. R. Smith

This radio telescope is a general purpose instrument that can be used for demonstration purposes, or adapted for specific observations as required. The units making up the receiver, excluding the pen recorder, can be carried in a briefcase and two aerials can be folded to pack on a car roofrack.

THE BASIC system operates as a phase-switched interferometer between 160 and 190 MHz where a clear space in

the band can be found. It can also be used in the full power, Dicke, drift interferometer and beam switching systems which are described separately. Components preceding the i.f. amplifier can be replaced for operation on other frequencies as required. The instrument consists of several self-contained blocks which can be adapted for specific experiments. A single positive 12V supply is used to simplify portable operation, and a car battery will provide a stable

supply voltage for two or three weeks. The total load current is about 55mA.

Both aerials were designed for 178MHz, although at present they are being used at 182MHz. In each aerial the reflector surfaces are of a cylindrical parabolic form consisting of parallel plastic-covered steel wires spaced at approximately 0.1 of a wavelength as shown in Fig. 1. Four flat panels of the reflector are placed to within 0.1λ of a parabola where $y = x^2/1.68$ m.

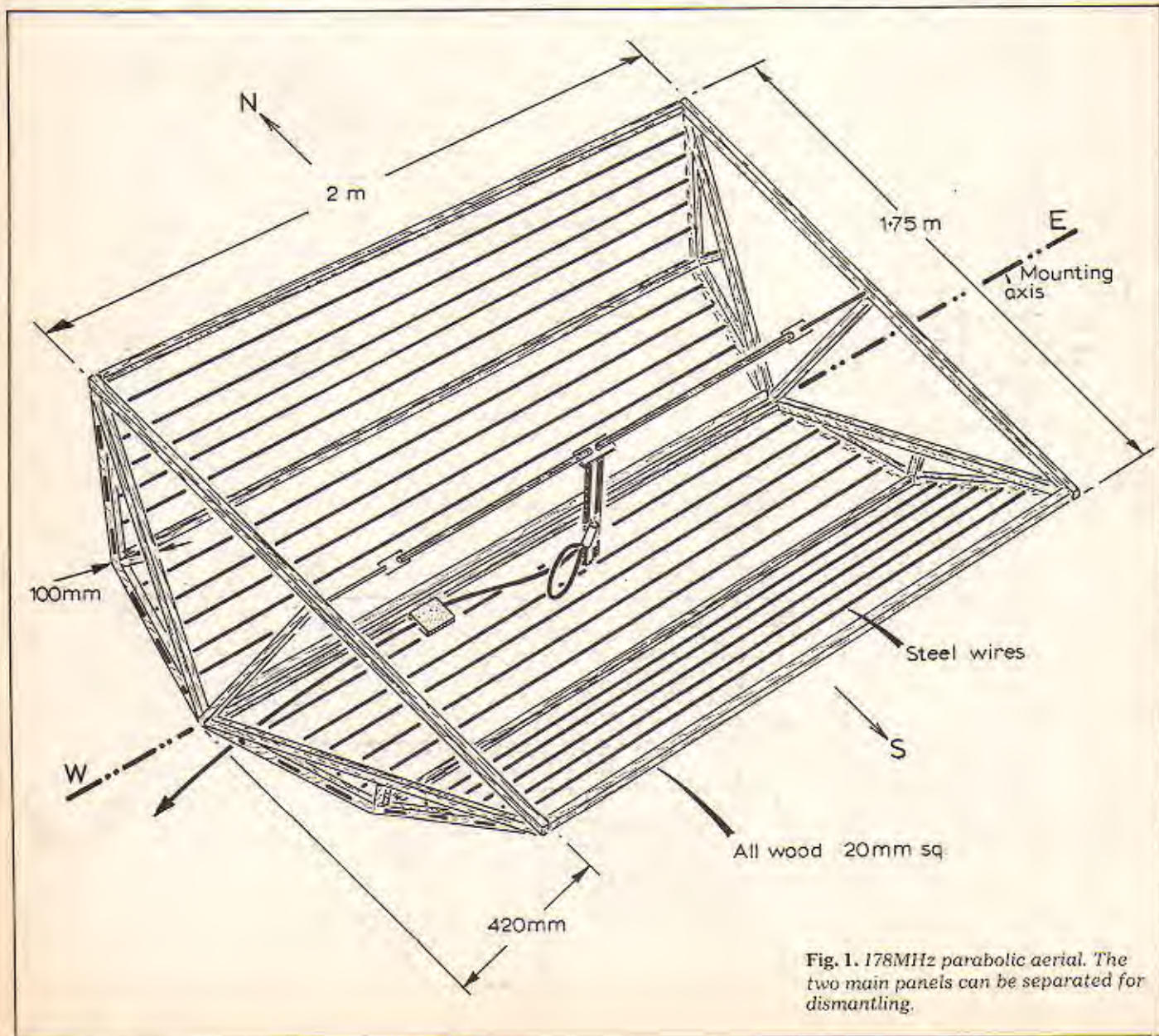

R.f. switching is performed by series diodes as shown in Fig. 2. The coaxial plug arrangement permits the switch to be used as a selector between two signal inputs, or by the addition of a $\lambda/2$ length of coaxial cable, as a phase reversing switch. The two-pole, four-way switch permits phase reversal of the switching square wave, or locking of the diodes to assist in tuning and testing the complete system.

The aerial amplifiers in Fig. 3 are located as close to the aeriels as possible to avoid degradation of the signal. A dual gate m.o.s.f.e.t. which is equivalent to a cascaded pair of transistors is used, and is resistant to cross modulation. Because these devices are susceptible to damage by voltage surges the input and output transformers are double wound and a zener diode is placed across the

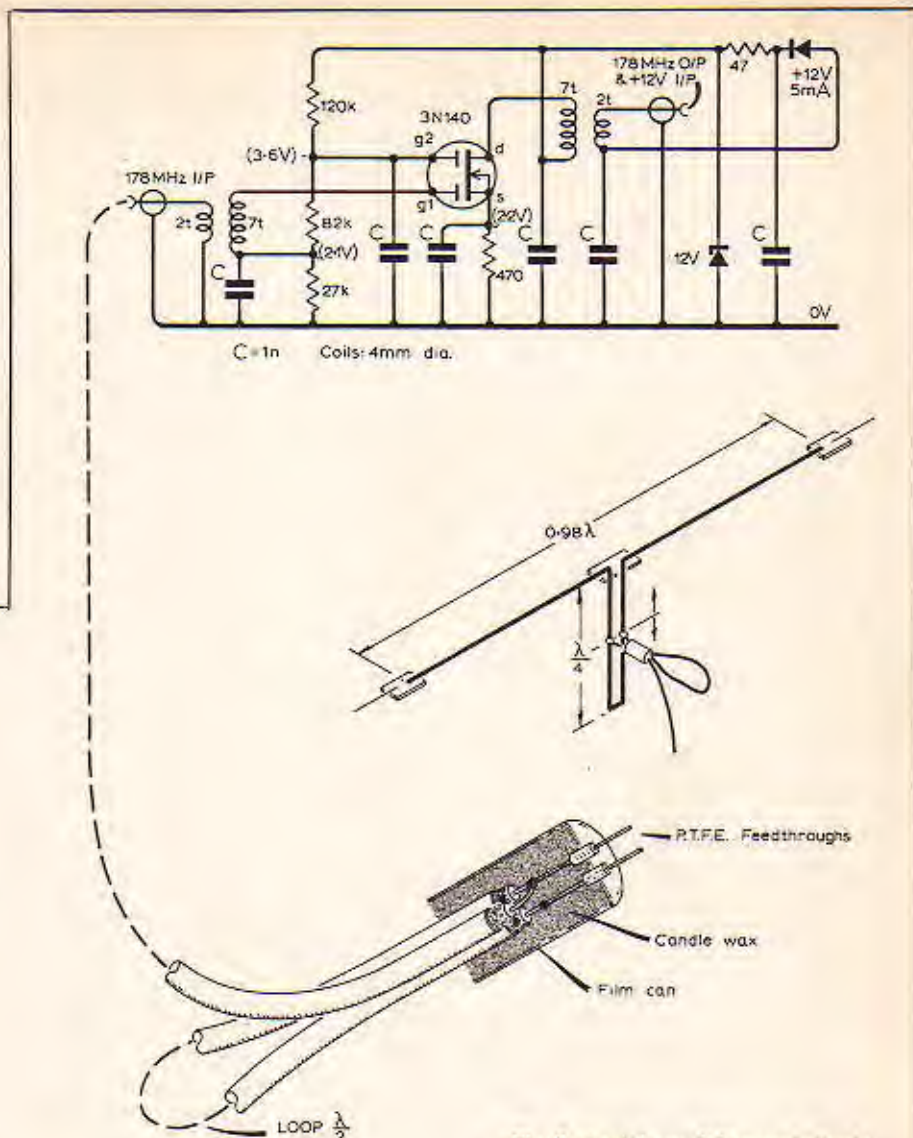

Fig. 2. Aerial amplifier and dipole matching system.

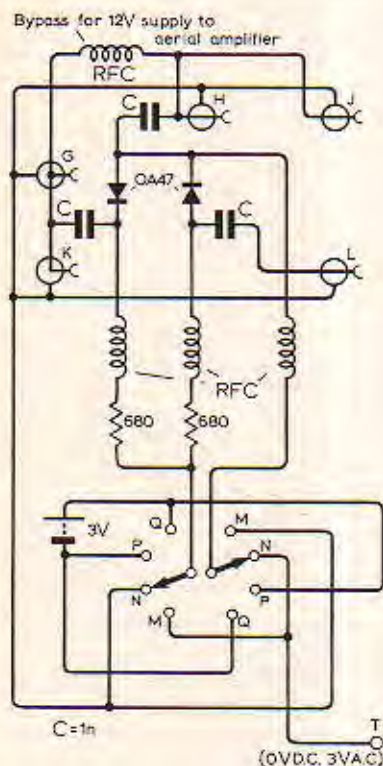
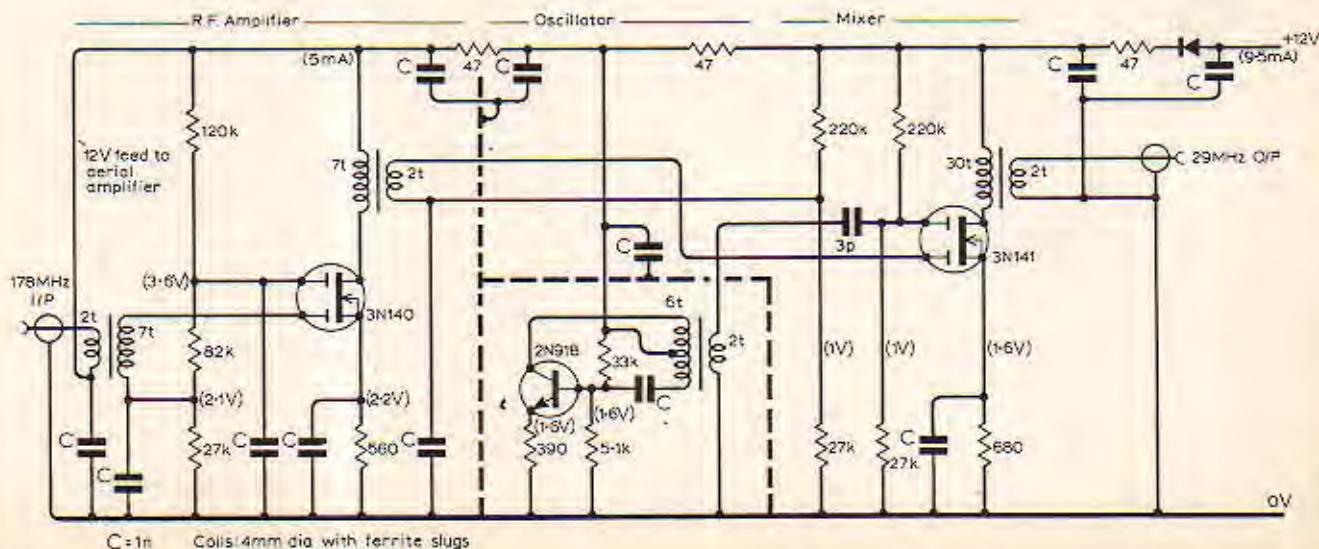

Fig. 3. Aerial switch.

Fig. 4. R.f. amplifier, oscillator and mixer.



C=1n Coils: 4mm dia with ferrite slugs

supply. A series diode protects the f.e.t. from reverse voltages.

The r.f. section in Fig. 4 is similar to the aerial amplifiers. A separate oscillator is used in the frequency changer, and mixing is performed by a dual gate m.o.s.f.e.t. Although a radio telescope for general purposes should have the widest bandwidth possible, it is difficult to find a clear space in the band. For this reason a narrow band filter consisting of three well-isolated parallel LC tuned circuits is used as shown in Fig. 5. Coupling is by capacitors of about 0.2pF made from two short pieces of wire twisted together. A single transistor amplifier is included to partly compensate for the insertion loss. The bandwidth is about 0.5MHz and the net

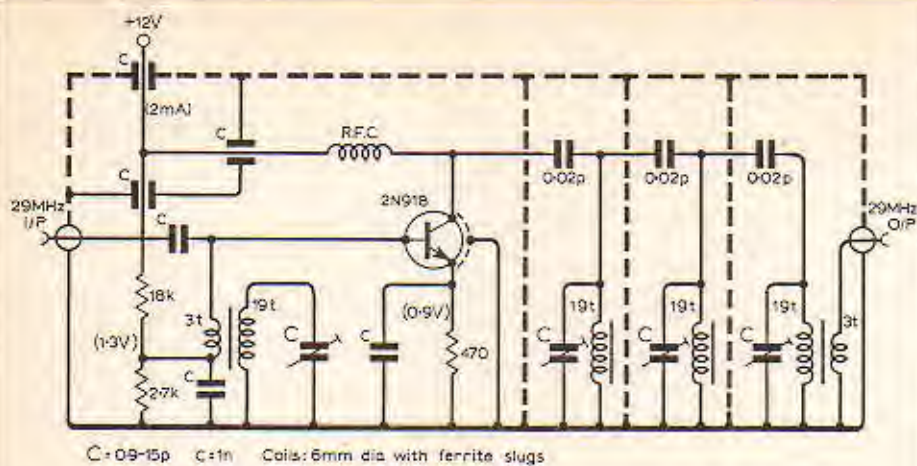

Fig. 5. Narrow band i.f. filter.

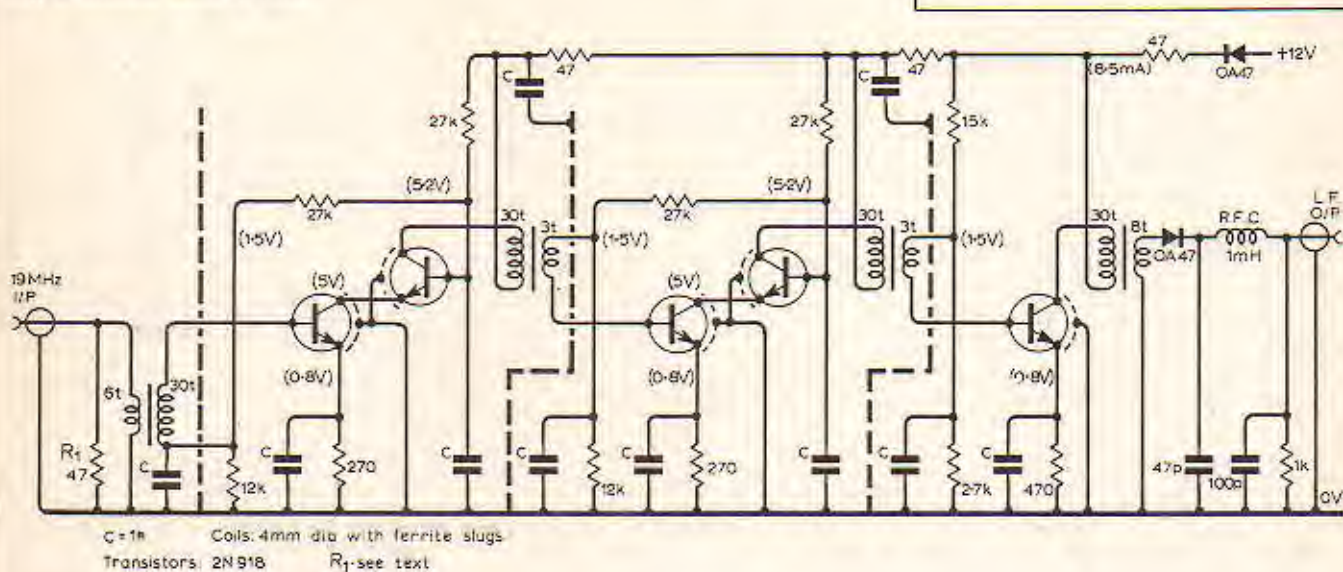

Fig. 6. I.f. amplifier and detector.

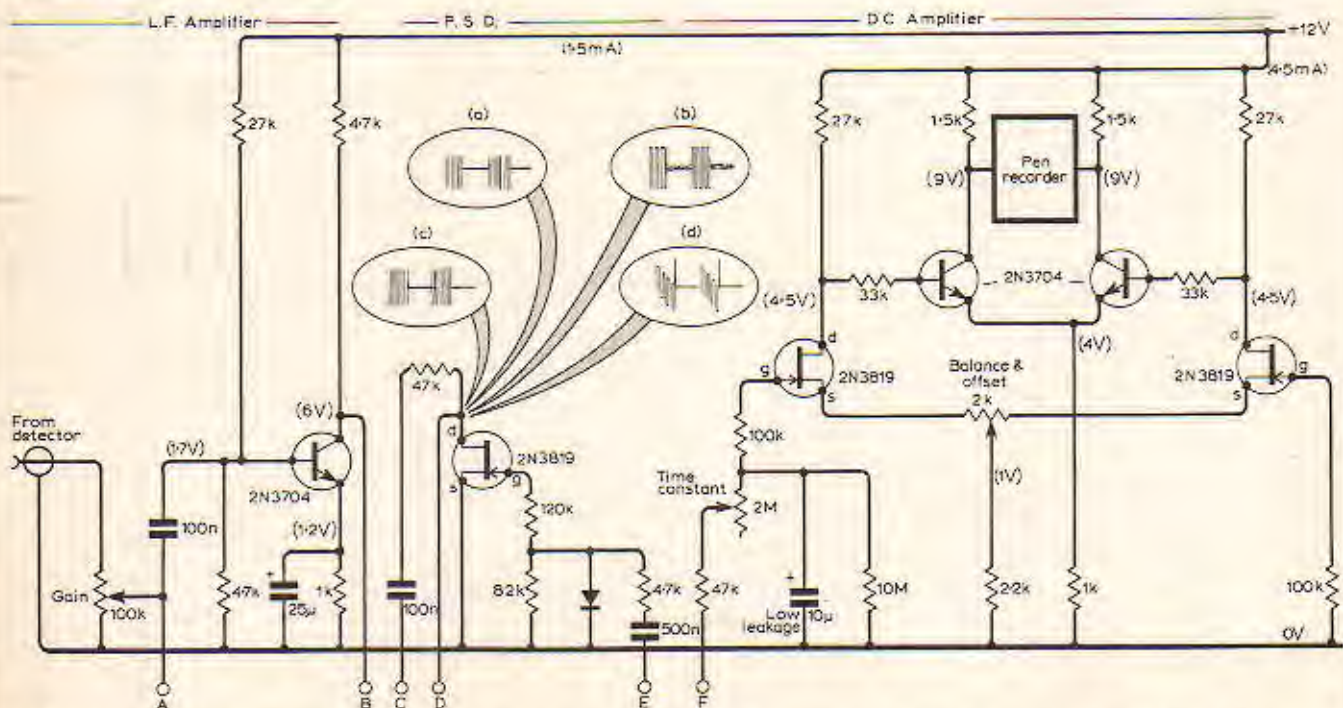

Fig. 7. L.f. amplifier, phase sensitive detector, and d.c. amplifier. Oscilloscope waveforms from point D: (a) Normal signals at aerial switch unequal - d.c. output proportional to the difference. (b) Normal, both inputs equal - zero d.c. output, (c) Overload. (d) L.f. phase shift in the system, and spikes also leaking from the square wave generator.

insertion loss is about 10dB. The i.f. amplifier and detector in Fig. 6 consists of two cascode pairs followed by a single transistor stage to give up to 2V from a 1000Ω output impedance. The original measured power gain was about 92dB, but this was reduced to 70dB by the inclusion of resistor R₁ across the input terminal, and some retuning to improve stability.

Construction

The aerial framework is constructed from 25 x 25mm timber, and the two main panels are joined by removeable wire pegs to permit easy dismantling. A full wave dipole is used as this conveniently fills the aperture. The dipole high impedance is transformed to a low impedance to match the balun by a short circuited λ/4 line. The position of the tap to the balun is found by trial and error. The dipole and λ/4 matching stub is made from one piece of 3.18mm diameter aluminium or copper wire and the insulators are cut from perspex sheet with holes at 25mm spacing. Brass connectors to the aluminium, and soldered connections to the balun are greased to prevent corrosion.

Each balun consists of a λ/2 section of 50Ω coaxial cable which gives a 4 to 1 impedance transformation as shown in Fig. 2. The coax and feed-through connections are housed in a 35mm film can which is subsequently filled with candle wax to form a hermetic seal. Similar baluns made eleven years ago and exposed to the weather are still working satisfactorily. The components are mounted on p.t.f.e. insulated studs or ceramic stand off tags attached to copper clad insulating board. The boards are bolted to the inside of diecast-box lids. All external connections pass through holes in the boards and lids. This method permits easier access for construction and maintenance. The transistors are located in holes which are drilled in the boards, and their screen leads are cut a short as possible and soldered to the copper cladding. All leads are kept as short as possible, particularly for the decoupling capacitors. Vertical screens cut from copper clad board are placed between stages, and where possible they are cut to bridge the transistors to provide electrostatic and electromagnetic isolation between the bases and collectors or gates and drains. The coils are wound on 4 or 6mm diameter formers with ferrite slugs. In the r.f. circuits the number of turns required is affected by the circuit layout and variations in the transistors.

As the detector output level is fairly high the i.f. amplifier in Fig. 7 is very simple. For some observations it can be omitted. In the phase sensitive detector of the same circuit the f.e.t. acts as a simple switch driven by the square wave generator.

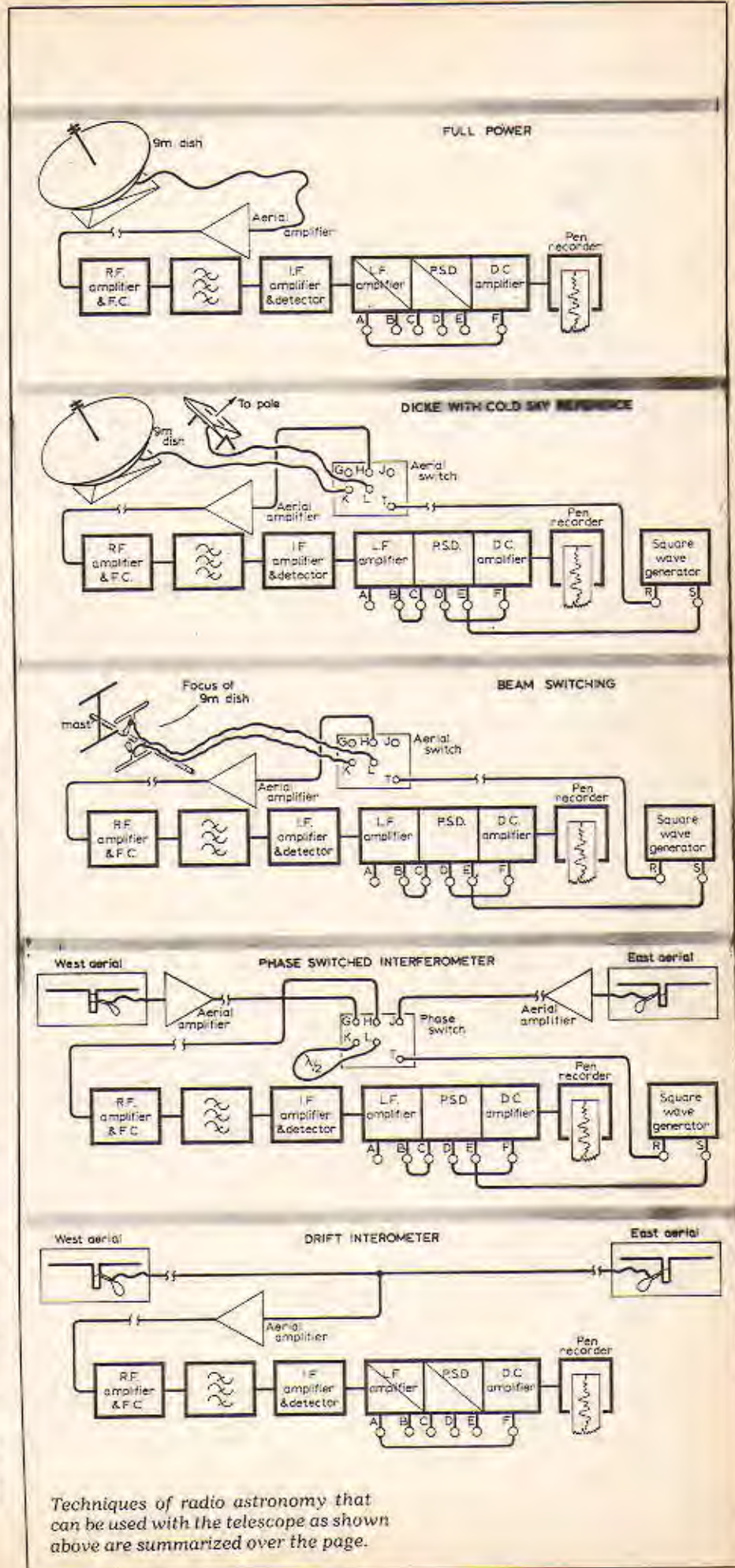

Techniques of radio astronomy that can be used with the telescope as shown above are summarized over the page.

To be concluded.

Radio telescope systems

Most natural signals from space are in the form of white noise and are similar in character to the noise generated in a receiver. Factors affecting the overall sensitivity of a radio telescope are receiver system noise, gain fluctuations, aerial collecting area, aerial efficiency, aerial feeder loss, receiver bandwidth B , and receiver output time constant T . The minimum detectable signal at the receiver is roughly equivalent to the noise recorded on the pen recorder. The system noise fluctuations and hence the minimum detectable signal level can be reduced by using a wide bandwidth and a long time constant which produces an improvement proportional to \sqrt{BT} . Bandwidths greater than 1 MHz and time constants greater than 10 seconds are desirable but unfortunately the bandwidth often has to be reduced to find part of the spectrum clear of man-made transmissions. This causes a loss of sensitivity. The output time constant needs to be between 0.1 and 2.5 seconds for recording rapid bursts from the sun, and from about ten seconds to several hours for galactic sources. This choice often depends upon the presence and type of interference.

The full power system consists of a single aerial connected directly to the receiver. The detector output is measured by a d.c. amplifier and a pen recorder. Often the d.c. component due to receiver noise is backed off by a stable bias supply. The full power system is very susceptible to receiver gain variations due to changes of temperature, supply voltage and component characteristics. These changes vary the output due to receiver noise and mask the output due to the signal. In the case of the Crab Nebula, the signal seen by the receiver is only 10^{-21} watts/Hz and will be lost in the smallest of receiver gain variations.

In the Dicke system the signal is continuously compared with the thermal noise produced by a high quality resistor that has been matched to the system input impedance. The receiver is switched alternately to the aerial and the resistor at about 500 Hz and the detector output polarity is also switched synchronously so that over a complete cycle the system output is

$$\propto \frac{(s+n) - (r+n)}{2} \propto \frac{s-r}{2}$$

where s is the signal, r is the resistor noise and n is the receiver noise. Because s , r , and n are all randomly varying quantities, the output still needs to be averaged by the output time constant and wide bandwidth.

A disadvantage of the Dicke system is that the temperature of the reference resistor is different to the equivalent temperature of most celestial sources, and therefore these signals can differ considerably. Any variations of system gain will be modified by this difference and show up as drift on the pen recorder.

The cold sky reference is a simpler system where the resistor is replaced by

an aerial pointing at a cold part of the sky which will have an equivalent temperature of a few degrees above absolute zero. If the aerial is pointing to the celestial pole, it will always see the same portion of the sky in spite of the Earth's rotation.

In the drift interferometer two aerials are set up on an East West base line facing a selected point in the sky on the meridian. The aerials are connected in parallel through two equal lengths of feeder and the rotation of the Earth scans the aerial beams across the sky at a fixed declination. When a radio source is on the meridian, the path lengths through each aerial to the receiver are equal and the signals collected by each aerial add together. The pen recorder responds to the sum of the signals plus the receiver noise. When the Earth has rotated so that the path length through the West aerial has shortened by a quarter of a wavelength, and increased through the East aerial by a quarter of a wavelength, the signals will be 180° out of phase and will therefore cancel. At this point the pen recorder trace will fall to the receiver noise level. After the path lengths have each changed by half a wavelength the signals are again in step and add together.

A sinusoidally varying multi-lobe or fringe pattern is recorded above the receiver noise bounded by an envelope corresponding to the overall beam-width of the two aerials.

One advantage of this system is that the signals from a celestial source can often be distinguished from unwanted signals.

In the phase switched interferometer the advantages of the Dicke, drift interferometer and cold sky reference systems can be combined. If the connections to one of the aerials of the drift interferometer system are reversed the fringe pattern is shifted sideways by half of a fringe width. A source located at a fringe maximum will then be located at a fringe minimum. Therefore, at any one moment the system is seeing the source, and in the next moment the cold sky alongside it. Reversal of the aerial polarity can be by two germanium diodes acting as r.f. switches to alternately insert or remove half a wavelength of the aerial feeder. Separation of the signal from the receiver noise is accomplished by feeding the receiver output to a synchronous detector as in the Dicke system.

When the source is on the meridian, the output is

$$\frac{(2s+n) - n}{2} \propto s$$

where s is the signal due to one aerial and n is the receiver noise. When the source has moved by half a fringe, the output is

$$\frac{n - 2s + n}{2} \propto -s$$

Unwanted signals reaching one aerial only or both aerials incoherently are treated as receiver noise unless there is gross overloading.

IN BRIEF

●SEMA, whose gas detection equipment we described in December (P.42), have moved to Unit 32, Dundonald Camp, Irvine, Ayrshire, KA11 5BJ. The telephone number is Irvine 311252.

●Millbank Electronics have been awarded an Export Year Award by the Federation of Sussex Industries for overseas sales of industrial sound equipment. The scheme was judged by the British Overseas Trade Board and the prize was presented by Sir Derek Ezra in November.

●A new 25,000 line local telephone exchange and expansion of existing exchanges by 42,000 lines are planned for Hong Kong. The largest exchange at Kwai Chung will be expanded from 54,000 to 69,000 lines. In the centre of Hong Kong 13 out of every 100 subscribers are on the phone at once in peak periods, each call lasting just over a minute. In Germany the figures are 7 and $2\frac{1}{2}$ minutes. The work will be done by Siemens.

●The Spanish Government is to build 28 h.f. communications transmitters to US Defense Communications Agency standards. Twenty-three will be 10,000W and the rest 40,000W, all supplied by Communications Electronics of Dallas, Texas.

●Mr P. F. Fenton is to succeed Sir Edward Fennessy as managing director, Post Office Telecommunications. Sir Edward retired in July, since when the acting managing director has been Mr Kenneth Cadbury, who is to become deputy managing director.

●The German magazine *Funkschau* reports that Bogen, the makers of magnetic heads, are in financial difficulties. Wolfgang Bogen has left the company and a minority shareholder, Dr Helmut Becker, is now manager. The property of the company, as well as that of Bogen himself, has been taken over by the Berlin Senate.

●New TXE4 exchanges will be installed in Birmingham and Bristol early this year. The £35 million Bristol contract will increase the city centre exchange's capacity from 16,000 to 28,000 lines, and the £25 million for two exchanges in the Midlands exchange building near Birmingham's New Street Station will begin by replacing 19,000 lines of Strowger equipment.

●Radio London have sent us a letter they have received from a South African listener requesting a QSL card. For about seven minutes at around 10pm on November 17 Mr V. Korinek received the allegedly local radio broadcast on 1,457 kHz.

A basic radio telescope — 2

Construction, performance and testing

by J. R. Smith

WHEN NO SIGNAL coherent with the square-wave generator is present the noise blocks are symmetrical about the zero line and the mean d.c. output is zero. If the signal and the square-wave are coherent the noise blocks are not symmetrical about the zero line and the d.c. output appears with a polarity dependent upon the phase of the noise blocks with respect to the square wave. Integration of the output signal is carried out by a RC circuit. The time constant is adjusted by a variable 2MΩ resistor and the capacitor is selected for low leakage. The maximum time constant obtainable is 20 seconds. The d.c. amplifier consists of a bootstrapped pair of transistors with some carefully matched devices to provide an acceptable temperature stability. Field effect transistors are used for the input stage to provide a high input impedance which permits a long time constant. To obtain an equal mark-to-space ratio, an asymmetrical astable multivibrator is used to drive a divide-by-two monostable multivibrator, see Fig. 8. Buffer transistors provide low impedance outputs, and normal or inverted square-wave outputs at 1kHz

are available as required. Early trials showed that these outputs require filtering to prevent radiation of r.f. fields. Values for r.f. chokes and capacitors are best found by trial and error, but excessive filtering degrades the shape of the square wave. The 12V power supply must be stable to within 5mV. As the total load current is about 55mA dry batteries can be used for short periods or a car battery for longer periods. With the last mentioned the

voltage should be stable, after a charge, if it is partially discharged before use by about 5%.

The values of most of the components are not critical although high stability resistors are used in potential divider circuits and the d.c. amplifier. Radio frequency chokes are made by winding between twenty and thirty turns of enamelled wire on polythene tubing of 5mm in diameter. The i.f. chokes consist of twenty to thirty turns

Measured performance of various stages

Stage	V_d when	I _d to double	Noise factor	Noise figure	I_d/V_d	dI_d/dV_d	Stage gain	
	I is 0 V						V_d mA	Absolute
Aerial amplifier and coax	0.37	4.7	5.7	6.7*	0.8 0.1	8	16.2	12*
Frequency changer	0.15	14	15	11.5	13 0.1	130	11.3	10.5
Filter	0.12	—	—	—	38 0.03	1270	1/28	-14.5
I.f. amplifier	0.12	5	6	7.7	4.5 0.1	45	1.05×10^7	70.2

* A 3N140 i.e.t. should achieve a noise figure of 4dB. Some improvement in gain should also be possible.

I_d is the diode anode current. The diode resistor is 50Ω and the voltage gain of the d.c. amplifier is 18.5 (absolute).

V_d is the detector voltage. Output power is assumed to be proportional to V_d because a square law detector is used.

Fig 8. Square-wave generator

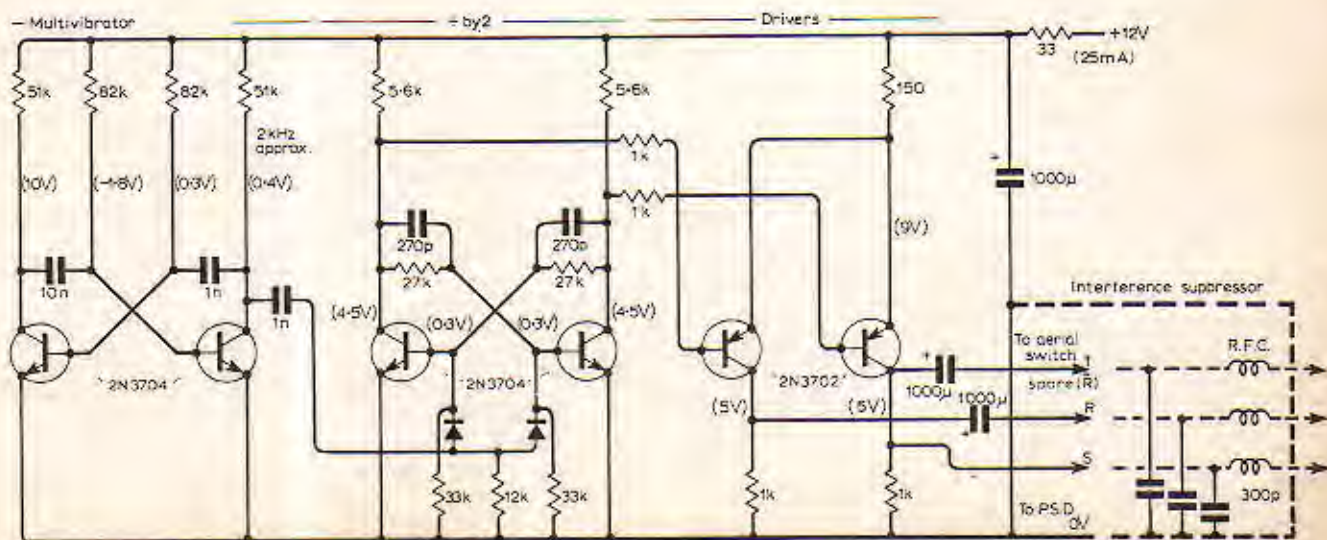

EEA conditions for CB

The Electronic Engineering Association's working party on citizens' band, set up a year ago, recommends that the service should operate in a frequency band "between 60MHz and 500 MHz". The system should avoid "the worst aspects of the 27MHz systems now operating in the US and some 15 other countries," should provide work here, and should provide an outlet in overseas markets, especially Europe.

The working party's view that the service should be priced so as to be attractive to a large number of people — it recommends a unit price of no greater than £150 and a licence fee of £5 to £10 — indicates that the EEA is now in favour of the introduction of some form of c.b. They estimate that between two and ten million domestic and small business users would welcome a c.b. service in the UK.

The report also recommends that equipment should be approved to an agreed Home Office standard, and that all units should have a "unique and continuously transmitted identity", which should be stamped on the licence form supplied with the unit. This echoes a view of the Citizens' Band Association.

Hand-held transmitters should not exceed a power of 100mW e.r.p. and vehicle and fixed units should not exceed 1W e.r.p. in any direction. Distances should not exceed 8km, normally 2 to 3km.

There should be 40 channels with a maximum of 12.5kHz. Spurious emissions should be no more than 200 nW, depending on the band chosen. "It may be prudent that the service be opened with approximately ten channels in the middle of this block with the remainder held in reserve." Aerials should be no higher than 10m above the ground.

Users should not regard the service as reliable for emergency, security or business use, and action should be taken "to obtain European (EEC) agreement to a future c.b. service which would eventually replace the existing service".

The EEA working party will continue to examine developments in attitudes to c.b. The report had to obtain approval from the EEA mobile radio committee before it could be disseminated.

The Home Office told us they had no comment to make other than that they had already made clear their position about the shortage of frequencies and the dangers of interference to existing users. □

Hitachi update

Hitachi's announcement of their intention to withdraw an application to build a tv factory in the North-East came after our last issue went to press (January, p.34). The government has not been pleased by the result of the lobbying by the set makers, though it is difficult to believe that they were not relieved to have the decision taken off their hands.

In a radio interview the minister responsible, Mr Alan Williams, said it was his impression that Jack Akerman and Sir Richard Cave, the chiefs of Mullard and Thorn, were first of all asking for guarantees from Hitachi if the factory were built. "Having got the guarantees they then said, 'Well we don't care what guarantees you have because we don't believe them anyway'."

John Hobbs of the North-East Development Council described it as "A campaign of



figures which have been wrong, of racial arguments... It has been a disgraceful episode for the country as a whole." His reference to racial arguments concerned a remarkable lapse from *World in Action's* usually-high standards in which a film clip showed a ferocious sword-wielding Samurai.

The *Financial Times* devoted considerable space to the decision on December 8. A leading article said the decision had made the government the laughing stock of the international business community. "It is an ironic commentary on the so-called industrial strategy that a decisive role in persuading

the government to give in to the protectionist pressure has apparently been played by two of the sector working parties. It is well known that the main role of these bodies is to serve as lobbying instruments for the industry concerned, but up to now they have not been noted for getting things done. The National Economic Development Office, which often finds difficulty in explaining the work of the sector working parties, can now point to a concrete achievement; they have protected a domestic industry from a new source of competition and dealt a damaging blow to the government's stated policy of encouraging inward investment."

Elsewhere the paper points out that the government's embarrassment is due to their having promised Hitachi a year ago that permission to come to Britain would be granted under certain conditions. The embarrassment is compounded by the fact that one of the main planks in the opposition case was that Hitachi could not be trusted.

It may be, however, that Hitachi can turn the present hangover from the protectionist binge to their own advantage. It is too early to consider their decision final.

● US restrictions on tv imports from Japan have caused Hitachi to form a joint tv company with General Electric. The new company, to be called General Television of America Inc, will have headquarters in Portsmouth, Virginia, provided government approval is obtained. □

CEI counter-attack

Last year was a tough one for the Council of Engineering Institutions. There were times, just before the Finniston committee was announced, when it seemed the CEI didn't have anyone to speak up for it. But it begins to look as though the CEI is taking account of the criticism, even if only to ensure its own survival. Commonsense and technology committee chairman Arthur Palmer has been a persistent critic of the council yet, referring to the CEI's offer to hold regional conferences as we reported last month, he told us he thought it was "extraordinary" how completely the CEI had turned over a new leaf.

In mid-October there was a declaration on trade union recognition the vehemence of which would normally be considered astonishing from what the civil service calls a quasi-autonomous, non-governmental organisation, or quango.

The CEI's view is that professional engineers should join an appropriate trade union in their own interests. When, therefore, W. H. Allen of Bradford refused to grant recognition to the United Kingdom Association of Professional Engineers, and ACAS, despite a 79% vote in favour of trade union membership by those at Allens, failed to recommend such union recognition, the CEI issued a statement condemning ACAS. "The conclusion reached... is totally opposed to the overwhelming weight of evidence submitted by the negotiating parties," said the CEI. The decision "makes a mockery of the democratic process and poses a serious threat to the interests not only of professional engineers but all those to whom freedom of personal choice remains important." Strong stuff. Now the CEI have published a 20 page booklet summarising all the industrial relations legislation of the past few years and its effects on the engineer's working life. It costs 50p.

On top of all this comes the latest survey of

professional engineers, the CEI's sixth since 1966. It shows that an engineer's income has fallen even further behind that of his colleagues since the last survey in 1975. According to the CEI, this is attributable to incomes policy and inflation. The median income of an engineer, adjusted to allow for the increasing cost of living, actually fell for the first time since the surveys began, from £2,315 to £2,180. Taking the year 1965/6 as 100, the engineer is now getting 112, compared with 119 last year, and the real average earnings index of all industries is 131 compared with 135. The chairman of the committee which produced the survey, Mr Brian Hildrew, described the figures as "rather alarming."

The report shows that Engineers in the East Midlands earn less than anywhere else, and that the lowest pay is earned by those working for firms of consultants. If you live in the Irish Republic, however, you're probably well-off, especially if you're a self-employed man; the self-employed, contrary to their own propaganda, earn a median income of £8,000, their nearest rivals being university teachers at £6,650. If you take into account that consultants are mostly self-employed, the picture is of a group who earn more but are prepared to pay less than anyone else.

Another feature to emerge from the survey is that there has been a steady decline in the number of engineers who work in commercial or industrial companies (44% compared with 46% in 1975) and a corresponding increase in the number of engineers who work in the public sector (42% and 39.5%). This may be because salaries are better for the engineer in the public sector, especially if he belongs to a trade union.

This may account for an increase in trade union membership from 41 to 44% in the last year. □

BS9000, the hidden face of protectionism

If a recent symposium at British Standards Institution headquarters is anything to go by, users of electronics components are firmly in favour of the universal adoption of BS9000. Questions centred on problems of implementation rather than doubt about the scheme itself. Over 1,100 approvals have now been granted for various components.

In the past component makers had to contend with a number of similar but distinct standards according to whom they were supplying. These have included CV and DEF military standards, and Post Office, CEEB, BS and commercial specifications.

Now, a supplier who has won BS9000 approval for his products can guarantee, if the scheme works properly, that his components can meet consistently any standard he agrees with his customer and this saves the customer the trouble of having to check the components at goods in. It also means he can use any BS9000 supplier he likes, and it may also result in more uniform finished products.

Nevertheless, acceptance of the scheme has been slow. The component manufacturers were in favour but the users, fearing that it would not be flexible enough to meet their particular requirements, dragged their feet. The Post Office seemed particularly slow to come into the fold.

When BS9000 surfaced ten years ago it met almost universal indifference. In the first five years the number of approvals applied for and granted was only 270, roughly a quarter of the present total. A year ago the figure was

651, so that nearly half the approvals have been granted in the last year.

There have been various explanations for the sudden rush or enthusiasm. The BSI attribute it to the wider range of components which can now gain approval and the wider publicity the BS9000 has received of late. But two other reasons, one national, the other international, lurk behind the snowballing growth of the scheme.

In the first place there is no doubt that the Ministry of Defence has been putting pressure on component makers to come into the system. This may be because, as the defence purse strings are pulled tighter, the MOD wants to shed itself of costly peripheral activities like component approval, though the MOD's Electrical Quality Assurance Directorate (EQD) is supervising all the approvals on behalf of the BSI.

BSI officials admit that suspicion of the scheme so far has been based on the (unjustified) notion of a plot between MOD and the component makers to force users to accept only military spec components.

But the international implications are what make BS9000 so attractive, and go a long way to explaining why most of the enthusiasm for the system has come from the component makers.

BS9000 is but the first stage towards the international standardisation of components. A standard will first be drawn up for Western Europe under the auspices of the CECC, the Electronic Component Committee of the European Electrical Standards Committee.

Based upon experience in Western Europe the world regulating body, the International Electrotechnical Commission (IEC) will draw up a standard which will make components made according to it saleable anywhere in the world. In theory it is this that the BS9000 advocates are working towards.

But the real game was given away several times at the BSI symposium. It looks very much as though BS9000 will be the basis of the CECC standard — in many cases the corresponding CECC and BS9000 documents are the same but for the name — and hence of the IEC standard.

This is more than a matter of national prestige, they think. In their minds it means that British companies who have already been conforming to BS9000 standards will have an advantage when the other countries, especially America and Japan, are still catching up on the necessary procedures.

Thus the talk was not so much of how quickly the world standard could be adopted as of how far behind those dreadful foreigners were. The official reason given for excluding Hong Kong from the scheme, for example, was that the distance involved would make the crown colony difficult to administer within the scheme. Behind that, however, might lie concern about the level of electronic imports from the Far East.

In truth the foreigners no longer seem behind at all. Two years ago a Japanese team visited this country to find out all about BS9000. A system based on BS9000 is now operating in Japan. In January last year legislation was introduced into the American Congress to overcome the legal difficulties, caused by the anti-trust laws, of American manufacturers banding together to bring about component standardisation.

Anyone imagining, therefore, that BS9000 is going to give the British components industry any kind of advantage in world markets is deluding himself. □

Gatwick to manage without ground radar

It may be another five years before Gatwick airport is equipped with ground radar, according to a House of Lords answer in mid-December. The installation, to cost about £½ million at current prices, is awaiting the building of an elevated control room in the terminal area.

The answer came in response to a question from Conservative Peer Lord Braye, who suggested that there might be a serious accident at Gatwick before the equipment goes in which could be avoided if the authorities acted sooner. The Lord in Waiting, Lord Oram, replied that "Expenditure on ground radar could only be justified where traffic levels and the complexities of the taxiway system are such that real dividends would accrue in terms of safety and expedition."

● Lord Braye's question may have been prompted by the Tenerife disaster in March, the worst in aviation history, when 577 people were killed as two jets collided on the ground. Ground radar could have helped to avoid the disaster.

Heathrow is the only British airport, and one of the few in the world, which has radar-monitored movements of aircraft on the ground, though until recently the equipment, Decca's airfield surface movement indicator (ASMI) was better suited to use at night. One reason for its installation is the large number of passengers the airport

handles; at 24 million a year this makes it the busiest airport in the world. Gatwick handles a mere 6.4 million a year.

In addition, the ground movement control cabin where the equipment would go, now in Gatwick's 'old office block', is to move to

a new position above a block on which work began in December. Since, however, the old and new buildings are at right angles, part of the apron will be hidden. The finishing date for this new block is 1979, according to a Gatwick spokesman, but Lord Oram gave the likely finishing date as 1981 to 1982. At that time another building, called the North Pier development, is planned for completion as part of a £100 million improvement plan, so it could even be that any ground radar installation may be put there.

A spokesman for the Civil Aviation Authority, which is responsible for safety at Britain's airports, told *Wireless World*: "If we find it is going to be of value there then we will do something about it, but so far it hasn't been proved."

A Gatwick spokesman said that, while it would be foolish to say there was no chance of an accident happening in the next five years which ground radar might have avoided, "we would like to think that we're better off than Tenerife." A larger worry at the moment was the movement of passengers through the building work.

But it seems likely that a case will eventually be made for Gatwick's having the equipment. The airport is now taking an even greater share of Heathrow traffic. It will take ten million passengers in 1980 and 16 million five years later, most of the increase attributable to the use of larger aircraft. □



Airfield surface movement indicator (ASMI) screen at Heathrow airport. See 'Gatwick to manage without ground radar.'

Investment plans look to Viewdata/teletext

Mullard has spent £3.5 million in the last two years on the l.s.i. plant at Southampton and a further £4.5 million is planned for the next two or three years. At a recent press conference the director of Mullard's industrial division, Bill Everden, said that at present the consumer i.c. market was around £12 million, but that by 1982 the figure would exceed £30 million, of which Mullard expect to take a healthy £18 million.

One of Mullard's main products is a remote controlled teletext/Viewdata package which is currently being prepared for market trials. This system comprises a set of four, recently-announced l.s.i. chips for teletext, a video processor i.c., data acquisition and control i.c., digital timing chain i.c., and a character generator i.c. These devices are used together with seven 1k rams, two synchronous counters, and an adder. Mullard expect to have complete teletext units in production at Southampton later this year.

The Viewdata section at present consists of two modules. A line coupling unit (l.c.u.) which enables a standard telephone line to be connected via a jack socket, and provides all of the necessary interface for the microprocessor-based Viewdata acquisition/control section which itself acts as an interface between the l.c.u. and the teletext decoder. The v.a.c. module receives information from the Viewdata computer and feeds it to the teletext display circuit. Also, it transmits requests for new information from the remote control to the computer. The automatic user-identifier and password generator is included and uses a p.r.o.m. for the number storage.

The Viewdata modules can be added to the teletext system without any modification. Although the modules at present use standard components supplied on two printed-wiring boards measuring about 165 x 305 mm and 150 x 230 mm, Mullard say that l.s.i. chips for Viewdata should be available in 1979.

The cordless remote control end of the package is based on the SAA5000 and SAA5010 i.c.s which have recently been available to the industry. These devices have been designed to operate with a colour television receiver and teletext decoder, while a Viewdata mode of operation allows the control of an additional viewdata-terminal.

Mullard are also working on video games again based on the 2650 microprocessor together with the 2636 programmable video interface. Their system uses the object oriented approach where r.a.m.s contain the object description specified by the microprocessor. Each r.a.m. has its own co-ordinate register with which the position of the object is controlled. During a game the 2650 transfers each object pattern into a r.a.m. and sends out the appropriate location codes to the corresponding co-ordinate registers. This system, say Mullard, simplifies the software requirement as compared with the alternative r.a.m. mapping system. The hardware for the video games will be the cartridge format which enables the system to be easily expanded.

Digital tuning is another area where Mullard have recently produced i.c.s. Called



In the background Mullard's microprocessor-based Viewdata acquisition/control unit. Bottom left shows their teletext module based on four l.s.i. chips, and bottom right shows an infra-red remote control transmitter and receiver.

digital channel selection, this system operates by storing the frequency of each t.v. channel in a r.o.m. The t.v. receiver is tuned to the selected frequency by comparing the tuned frequency with an internal quartz-controlled oscillator. With this system, pre-setting can be carried out without any channels on the air. Because each channel number is stored in a r.o.m. the number can be displayed to identify a station. □

Meteosat: no hitches, almost

The first white light and infra-red pictures of the earth's surface and cloud cover have come back from Meteosat, Europe's first weather satellite. To NASA's immense relief the Thor Delta 2914 rocket took off at 1.45 GMT on November 23, and went into geostationary orbit over the equator at 0° longitude at quarter past six the following evening. There had been three postponements, one from November 15 to 17, another to November 21, and then to the 23rd.

Meteosat is one of five equally-spaced weather satellites which will be taking part in a world wide programme. There will also be two American, one Japanese and one Russian craft. Additional information will be gained from platforms, buoys, balloons and other sources. Together they will provide a continuously-changing picture of the world's weather, offering advance warning of typhoons, hurricanes and torrential rain. World Weather Watch involves 145 countries apart from those sending up satellites and the first collective observation period is due to start no later than December 1978.

Meteosat revolves 100 times a minute, building up its pictures by tilting its telescope. One line by line scan picture is taken every 30 minutes, the visible image being of 5,000 lines and the infra-red 2,500 lines. Resolution is 2.5km in daylight on the visible picture and 5km on the infra-red. The picture includes Europe, Africa, and parts of the Middle East and South America.

Another part of the payload transmits data and relays meteorological information to ten ground stations operated by those taking part in the programme. It collects and re-transmits information from the remote weather stations and from other satellites.

Users can receive the Meteosat pictures direct or, via Meteosat, from Darmstadt in West Germany, where the pictures are improved by computer processing. □

"Instrument makers prospering"

Britain's makers of electronic instruments have held on to their share of the export market despite recent rises in the value of sterling, according to the managing director of Jordan Dataquest financial analysts. Mr Roger Coghill, speaking on publication of Jordan's survey of the instruments and communications industry, said that although the sterling rise had eroded British competitiveness slightly this had not been reflected in the volume of exports, and had resulted in increased profits for those in the industry. He pointed out, however, that this had not been reflected in wages and salaries. Even American subsidiaries, who paid higher wages than British companies, still paid less than could be obtained in other industries.

The instrument companies could expect even better profits this year as the recent dramatic improvement in the sterling rate worked its way through. "This is likely to be a boom year." Last year's survey had shown 19% of companies were loss-making, but this year the figure had dropped by 6%.

In the first half of the 1970s, says Coghill, the companies went all out for exports, largely because of depressed home demand. This led them to set up dealer networks in a great many foreign countries but the cost of this combined with changing trade condi-

tions meant that at one point about three years ago Jordan were able to demonstrate that there was an inverse relationship between profits and the amount of production exported.

Now the picture has changed to such an extent that not only are British companies making "acceptable profits", but they are buying into companies in the US in quite a large way. Jordan attribute this to low US company profits, high UK company liquidity as a result of earlier write-offs, and a reluctance to invest in new plant and machinery because of the low volume, specialised nature of the product.

The survey covers 376 companies and costs £38. In the last couple of months Jordan have also published surveys on computers and data processing, electronic component distributors, and component manufacturers. The ten largest private component manufacturers are making profits or around 3.6%, while the largest public companies, at nearly 11%, "remain one of the most profitable and growing sectors of British industry." In component distribution the number of loss-making companies has gone up from 10.3% to 16.1%, and there are only a few which have shown exceptional growth. These three reports cost £32 each. □

British hi-fi scene drama

A curiously bitter storm has been raging in the hi-fi teacup. Some audio manufacturers feel so strongly about equipment reviews now appearing in the hi-fi magazines that they have grouped together to agree not to submit equipment for review. So far the group includes KEF, Quad, Armstrong and B & W.

There appear to be two reasons for their strong feelings. One, they say, is that the writers are not truly independent and may, as consultants, be working for a company whose equipment is being reviewed or, worse, for one of its competitors. A more widely-held source of friction, however, is that they believe the tests and measurements aren't being properly conducted.

Although there have been rumblings of this kind for some time the row first emerged over the compilation of the second *Hi Fi Choice* on loudspeakers, due to be published this spring. There had been a violent reaction to the first, written in 1976 by Angus McKenzie. One remark about an American speaker had attracted threats of legal action. This time *Hi Fi Choice* hoped to review 60 loudspeakers, written by Martin Colloms.

Curiously, in view of their action in refusing to submit equipment for review, the manufacturers appear to have a high opinion of Martin Colloms, and mean to imply no criticism of his abilities. What they object to is that on the one hand he did a considerable amount of work for speaker makers Monitor Audio and, on the other, that the equipment he has at his disposal does not meet the standards of the equipment they have in their expensively-equipped laboratories. They do not agree with the methods of measurement, and say that in any case you cannot carry out a serious comparative study of as many as 60 speakers, especially if you have to work to a deadline.

Martin Colloms told us that as he had done a number of these large reviews he had come to realise what the pitfalls were and how to avoid them. He was not using entirely his own resources but had been given or was paying for whatever was necessary to do the job properly, including some equipment or facilities loaned by other manufacturers, or at independent laboratories and he had hired the largest anechoic chamber in Europe at Watford. The panel would consist of members of his regular team as well as others who would be paid for their time. The source material would be of studio standard, and the results would be based on measurements as good as anything the manufacturers could obtain, with the possible exception of those makers who had their own computers. This would not affect the value of the results. He said that most projects had to be done to a timetable in any activity, and you merely planned accordingly.

What really irks the manufacturers, however, is that the younger reviewers cannot be relied upon to see things the manufacturers' way. Before hi-fi became a huge industry the relationship between manufacturers and the writers for such magazines as there were was so close as to be almost cosy.

Now all that has changed. The audio consumer boom attracted new manufacturers and more magazines. More to the point, the confused buyer of equipment often has no patience with long rambling pieces of text sprayed with distortion figures and dBs,

especially when they come to no conclusion for fear of giving offence.

With the arrival of the consumer movement it was inevitable that someone would apply similar ideas to the audio industry, and that journals would appear which attempted to speak the consumer's language, even if they sometimes used it to say the wrong thing, and often scaled new heights of inarticulacy with each issue. The audio punter cannot understand why it is necessary to hear speakers in dimensionless rooms when his front room isn't like that, and he doesn't see why a group of people who take an interest in sound quality shouldn't listen to a lot of different speakers and publish what they think.

It was equally inevitable that manufacturers used to having magazines run for their benefit should look round for a scapegoat when the cold wind of competition blew in from the East.

The manufacturers now feel beleaguered. They resent the pressure exerted on them to co-operate with what they regard as a parasitic reviewing industry that has grown on the back of their own enterprise. They also feel that if a reviewer makes totally unjustified criticisms of their products a legal remedy is ineffective because the damage to their business has already been done, and they, unlike the reviewers, have employees to consider.

Hi Fi Choice reacted to the initial threat by inviting speaker makers to a lunch at a London restaurant, at which an agreed method of testing the speakers could be hammered out. The magazine said that KEF and the other three manufacturers did not take the opportunity to come. Raymond Cooke of KEF told us that he had not been invited, but that, having been to such occasions before, it would have been a waste of his time.

Hi Fi Choice aren't too worried. They're going to go out and buy the missing speakers anyway.

Peter Walker, of Acoustical Manufacturing, who make Quad equipment, and Chris Rogers, one of the newer school of audio reviewers are to take part in a debate on "Musicality, fact or fiction?" at the IEE. The date? St Valentine's Day. □

Post Office replies to Carter

The Post Office disagrees with the Carter committee's recommendation that there should be a Telecommunications Advisory Council. "Improvements will not be obtained by having layer upon layer of advice and monitoring for the new boards. In fact performance could be adversely affected if top management had to spend time servicing an additional body."

The Post Office welcomed the recommendation to split the Post Office into two corporations, one each for posts and telecommunications, but said it thought the Carter committee's assessment of the progress of System X (WW September 1977, p.51) under-estimated the extent of the preparatory work which had already been completed and the scale of the Post Office commitment. Contracts worth £30 million had already been placed. □

Tough next stage for optical fibre

If the optical fibre market reaches even a fifth of the £500 million a year predicted for it in 1985 then it will be well worth going into, according to Mr Ralph Baskett, head of STC's optical communications unit at Harlow. STC would hope to get a one-third market share.

In the year during which the unit has been operating it has made sales of £½ million, say STC. They refused to discuss individual contracts or orders, but say that telecommunications, military and industrial customers have bought optical fibre, fibre made up into cable, and optical systems such as terminal equipment, repeaters and multiplex equipment. Some customers are beginning to order optical equipment to solve problems, though most has been bought for evaluation.

Eighteen months ago the unit was a one man operation — Baskett himself — who was deputed to investigate optical fibre as a potential threat to STC's well-established coaxial cable business. By Christmas 1976 the number of people involved had reached ten, and now stands at 25. In a year, he estimates, it will be around 40, though recruiting the right people to manage the transition from a research to a supervisory and production operation will be hard.

Telecommunications will form 20% of the market in 1980, and lot of interest will centre on it because it is a familiar market. STC expect that telecommunications will take a bigger share of sales as time goes on, but not until well into the 1980s. Home sales will be depressed by the existing investment in copper conductors and only new links or "troublesome areas" will attract the use of optical fibre technology.

A strong point in optical's favour, however, is that it is, for the moment, virtually eavesdrop-proof, and our authorities are becoming ever more obsessed with security.

Similar considerations make the military market an accessible one, especially when added to optical's much smaller size for the same carrying capacity, lighter weight and rapidly improving ruggedness. But the military market is subject to political pressures.

A large home market may develop, however, among public utilities, such as the CEBG — who could use optical fibre communications without difficulty in the most electrically-noisy conditions that exist — and the Post Office, who have to connect to those electrically-nasty CEBG installations.

Optical fibres also make it possible to see directly into hazardous environments, such as those in ovens, areas of toxic or flammable gases or at nuclear plants, without the intervention of a camera. It would also be surprising if STC did not press the knowledge they have gained in submarine repeaters into service to advocate the use of fibre-optics under water. Baskett expects sales to reach £1 million in 1978. "The hard work will come next year. That first £1 million will show whether there's any market there or not."

● The BBC has sent colour tv pictures over 12 miles of optical cable and five repeaters spaced every two miles. The experiments began in November. The pictures were sent from Hitchin to Stevenage over the optical fibre link opened in June last year and then, via a loop at the Stevenage exchange, back to Hitchin. Some minor changes to the BBC's equipment were necessary to change its bit rate from 120Mbit/s to the optical link's 140Mbit/s. □

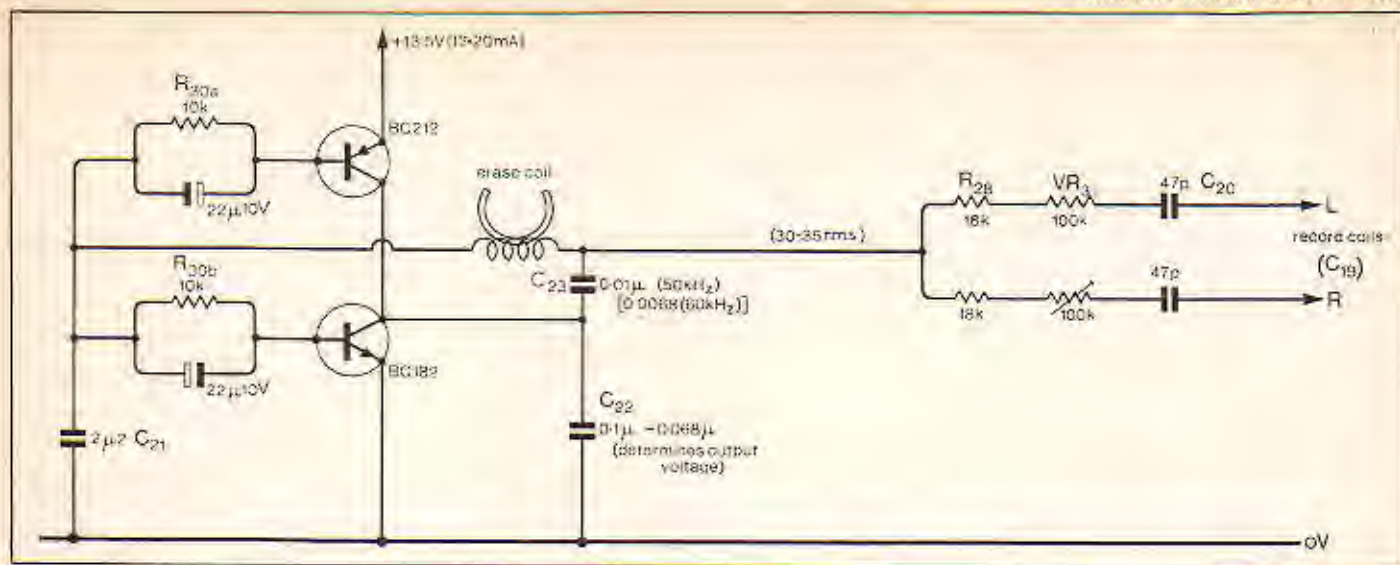

Fig. 2. Alternative higher efficiency bias/erase oscillator. (Note: Output voltage can be increased, to 80V r.m.s., by increasing C_{22} and reducing R_{20a} , R_{20b} if needed for future tape types).

erasure was 'wiping it dirty'. However, using a separate, though identical, bias oscillator, so that the on-cassette erase head could be disconnected, made no improvement in this respect. Indeed, the off-line oscillator was somewhat worse than the on-line one. Disconnecting the record amplifier also made no measurable improvement, while leaving the erase head in use but disconnecting the bias circuit from the record head left a tape noise level which was closely similar to that of the tape as received.

It was at this stage that the reason finally became clear. Typically, during recording, the magnitude of the h.f. bias waveform applied to the recording head in parallel with the signal is some 40-50dB greater than that of the signal. If the signal-to-noise ratio of the incoming signal is not to be impaired in the recording process, since the head is not able to discern the source of the signals which it receives, the s/n ratio of the bias waveform must be at least 60dB better than that of the record amplifier and signal source. It is probably this fact which has given rise to the widespread belief that good bias waveform purity is essential to low recorded noise level. Experimentally, it seems perfectly feasible to record with triangular and square-wave bias voltages (of the possible options a square-wave bias seems to have many advantages), non-sinusoidality seeming to be important only when this leads to bias waveform asymmetry and consequent even-harmonic distortion of the recorded signal. This arises because the recorded signal amplitude - in either direction - is bias voltage dependent.

Two steps can be taken to improve the oscillator signal-to-noise ratio: to improve its efficiency in terms of output-voltage swing for a given input power, and to reduce the proportion of wide-band noise generated by the oscillator which is transmitted to the record head along with the bias waveform. Improvement in the efficiency of the erase oscillator is effective in improving its s/n ratio because the

transistor collector current is the major source of wide-band noise, assuming that the losses in the LC network containing the erase coil are small. An alternative oscillator circuit giving about 35V r.m.s. for about 12-15mA h.t. supply is shown in Fig. 2. The original circuit requires some 100-120mA for 30V r.m.s. Although the waveform purity of the two oscillator circuits is very similar, there is a small s/n improvement in the use of the later one.

The second possibility, that of reducing the component of oscillator noise within the audio pass-band which is fed to the record coil along with the 50kHz bias waveform, can be accomplished very simply by reducing the value of the coupling capacitor in the bias circuit (C_{20}) to the smallest value which will give adequate bias voltage; 33-47pF is suitable. This change is more effective in reducing zero-recorded-level noise than the improvement to the oscillator, and for those who have already built this cassette recorder, this is the only recommended change. Together, these modifications lead to about 1.5-2dB improvement in tape background noise level.

Although each of the changes suggested above will, in normal circumstances, lead only to a small, and perhaps imperceptible improvement in overall s/n ratio, taken together the improvement can be 2-3dB, which is worthwhile.

Factors affecting signal-to-noise ratio

In the earlier article, attention was drawn to the need to avoid excessive caution in the recording process, in that the overall quality of a recording in which the recording-level meter needles

were occasionally driven 'into the red' would be likely to be much better than one in which, in the interests of low recorded distortion levels, the overload zone was always given a wide berth, and this point is worth restating.

However, it was expected, at the time of the earlier article, and this has been borne out by later experience, that the performance of the record/replay heads themselves would have a dominant effect upon the performance of the recorder. It seems, alas, to be a general rule that if a circuit design or process is evolved around some readily-available piece of commercial equipment or material, the publication of an article describing this will coincide with the discontinuation of the item upon which it was based.

Fortunately, in the case of the cassette deck, the Lenco cassette mechanism is identical mechanically, and at least as well made, as the Garrard unit upon which the prototype was based. However, the Garrard deck used the National Panasonic (Matsushita) record-replay head, type WY 435Z, which has a higher output and better h.f. response, and also a lower motor-noise pick-up, than some of the alternative types fitted in the Lenco unit. Luckily, it is a relatively simple matter to replace head units and to check the azimuth setting. Both the original head type and a superior unit of the same make are easily available so, in this particular instance, it is still practicable to copy the characteristics of the prototype if this is wished.

In view of the confusion which still seems to surround the design of cassette recording heads, and the relative merits of the materials used, it seems worthwhile to consider how these things will affect performance, and the basic characteristics of three different type record/replay heads are shown in Fig. 3. It can be seen from this that the use of a smaller head gap leads to a reduction in output at lower frequencies, but allows the increase in output with frequency to continue to a higher turn-over

frequency. The use of 'hot-pressed' (polycrystalline) ferrite, which has lower eddy-current losses, gives an even better h.f. response for the same gap width than laminated Permalloy, but the lower magnetic permeability of the ferrite material leads to a further lowering of output at lower frequencies. Materials such as Super Permalloy and Sendust offer, respectively, improvements in wear resistance for the same permeability, and improvements in permeability for the same low level of eddy-current loss, with respect to ferrite. However, with available materials, there is a general trend towards lower output and less good s/n ratio as the h.f. performance of the heads is improved.

An additional factor, in the head design, which affects the output from the head is the extent of the magnetic shunt provided by the proximity of the internal pole faces within the head. As can be seen from the schematic representation in Fig. 4, the narrower this internal face is the better will be the head output — and also the more quickly the wear on the head face, due to tape abrasion, will impair the gap integrity. Happily, developments in tape coating technology (reductions in ferric particle size and improvements in particle size uniformity) have markedly reduced the abrasiveness of the tapes marketed during the last few years. Measurements made on the prototype unit over the last two and a half years and 1000-1200 hours of use, have shown little significant change in performance after the initial, fairly rapid, improvement in output — presumably due to an improvement in tape to head contact as the head is lapped in.

The two remaining important factors affecting s/n ratio are bias level and head magnetism. Taking the last point first, it cannot be stressed too strongly that inadvertent magnetism of the record/replay head — which can occur for a variety of reasons, and will most certainly arise if it is handled or remounted — will lead to a most substantial degradation of performance, both in respect of sensitivity and in respect of h.f. response, so that common prudence suggests periodic head demagnetisation, just to be on the safe side.

So far as the effect of bias is concerned, this was dealt with in the original article (Part 2) and the effects of changing bias voltage levels were shown graphically in the original Fig. 9. It can be seen from this that the use of too high a value of h.f. bias has a bad effect on the h.f. recording levels, due probably to partial re-erasure. While many of the modern tape types, such as ferro-chrome and cobalt-doped materials, benefit from somewhat higher levels (typically 7V r.m.s., measured across the record coil with a low capacitance h.f. probe), the several cases which I have encountered in which the record/replay performance was much below par were due either to

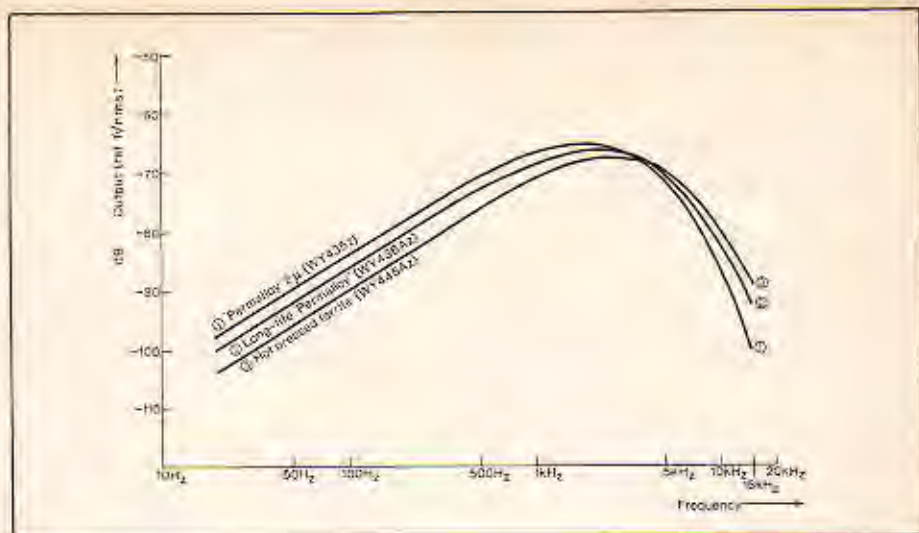

Fig. 3. Record/replay head characteristics.

undemagnetised heads or to excessive bias levels (in the 10-15V range!).

Since the actual output from the oscillator depends on the Q of the erase coil oscillatory circuit, there can be variations from manufacturer to manufacturer, and the coils fitted to the Lenco mechanisms tend to give a higher bias and erase voltage than that of the Garrard unit used in the prototype. This all to the good, but it is recommended that the bias adjustment pots (VR_3) be increased to 100k Ω from 47k Ω to give a wider adjustment range. It is appreciated that many constructors may not have access to suitable h.f. voltmeters for on-coil voltage measurements, but some simple practical experiments in recording a steady tone, using a pre-arranged programme of bias potentiometer adjustments, and choosing the setting which gives the highest output on the replay recording level meters — for a tone in the 300-1kHz range — will take one close to the optimum level, and such a test will compensate for variations in the bias requirements of differing types of record heads.

Head replacement procedure. Many horrifying tales of gross head wear, due to the use of cheap tapes, chromium dioxide formulations, Permalloy heads,

Fig. 4. Schematic drawing of tape record/replay head, showing flux linkage in head and tape.

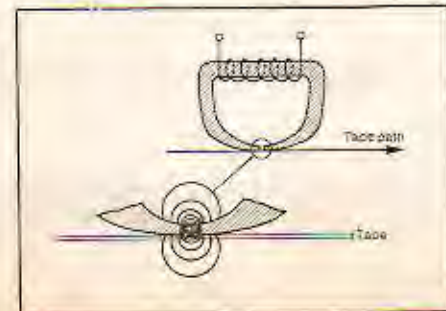

or excessive use of the recorder, have gained currency during the growth of popularity of the cassette medium, and many users must entertain some apprehensions about the inevitability of head wear incapacitating or impairing their machines, with the consequent need for specialist skills in head replacement. While the availability of a calibration tape, and a double-beam oscilloscope, makes this task a bit easier, simple alternatives will suffice.

Since many users will have built up their own library of tapes, recorded on their own instruments it will be more important when the time for head replacement approaches, that a replacement head should be in the same position as its predecessor, with respect to the tape, than that it should be in accurate 'azimuth' (gap verticality) and height conformity to the notional standard. A standard cassette recorded on their own machines will meet their needs. It is suggested that a range of frequencies from 300Hz to 10kHz should be recorded, with both channel inputs in parallel, at '0 VU'. (300, 1k, 3k, 6k and 10kHz for two minutes each will be adequate.) If the replacement head is in the same position as the head with which the test cassette has been recorded, the output of this tape will be of identical magnitude in each channel and the outputs will be in phase. Output magnitude can be checked from the recording level meters, and phase equality can be checked by a headphone or a.c. voltmeter across the two 'live' outputs of the recorder or subsequent amplifier. When the two signals are in phase, the voltage difference between the 'R' and 'L' channels will be at its least.

This test becomes more critical as the recorded frequency is increased, and as the higher frequencies are approached errors in azimuth also become apparent. If the gap between the replay head polepieces is not truly perpendicular to the direction of motion of the tape, the h.f. output will be diminished. If the condition of phase coherence between the two channels does not correspond

to the maximum h.f. output, the original record head azimuth setting was probably in error. If phase coherence between channels does not correspond to amplitude equality between them, the replacement head centre height is incorrect, which can be remedied by the addition or removal of washers from the non-adjustable end of the head mounting. For the record, a relative positional (angular) error of less than 0.05° can be seen by phase coherence checks at 10kHz, which is well within the azimuth accuracy requirements for optimum h.f. output.

The dimensions and agreed heights for the EIAJ (Japanese) 'Y' type, and Lenco/Garrard, 'Z' type, heads are shown in Fig. 5, together with the mounting system employed on the Staar type mechanisms. National Panasonic (Matsushita Co., Ltd.) offer two heads, WY 435 Z (2 micron gap Permalloy) and WY 436 AZ (1.5 micron gap, long-life Permalloy) which are of a suitable type for the Garrard and Lenco mechanisms. The latter head is of a superior construction, having a somewhat higher specific output, which compensates in part for the loss in sensitivity due to the narrower head gap, and allows the record/replay frequency response to be extended to at least 15kHz with suitable tape types. If the changes noted above are carried out, the approximately 2dB loss in output due to the use of the narrower head gap can be accepted with a final s/n ratio no worse than that of the original specification and the advantage of a better overall frequency response. It may well be that there are other head

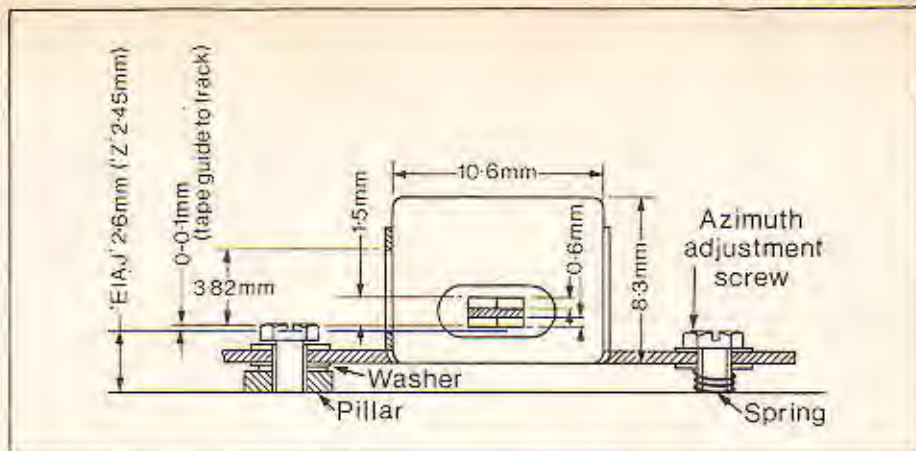

Fig. 5. Specified dimensions for cassette record/replay heads and method of mounting used on Staar mechanisms.

units, either now or in the future, which will be superior in performance to the National Panasonic units referred to above, since this, like that of tape composition improvements, is a field in which intensive development work will certainly continue.

Some adjustments to circuit component values are desirable if the 2 micron gap record/replay head is replaced with a unit having a 1.5 micron gap width, and these suggested changes are indicated by the values shown in brackets in Fig. 1 and 6. In the prototype, with square-wave response adjusted to give minimal overshoot, the h.f. response with the 1.5 micron WY 436 AZ head is -5dB at 15kHz, ref.

300Hz, using Fuji FX tape. There is little doubt that the system could be made to yield a more uniform h.f. response than this, if required, by accepting a less well damped response to a square-wave signals, but earlier experiments indicate that the subjective response of the system is not improved by the attempt to obtain optimal flatness of steady state frequency response by sacrificing accuracy of transient waveform reproduction.

It seems probable that this is because the tape recording mechanism is truly a 'slew-rate-limited' one, in that there is a minimum and readily calculable time which is required for a point on the tape, travelling at 4.75cm/s (1½in/s) to pass the 1.5 or 2 micron (0.000059 or 0.000078in) head gap. This implies that, for an ideally perfect tape impressed with a recorded square-wave, the output from the system cannot 'slew' at a greater rate than the replay head

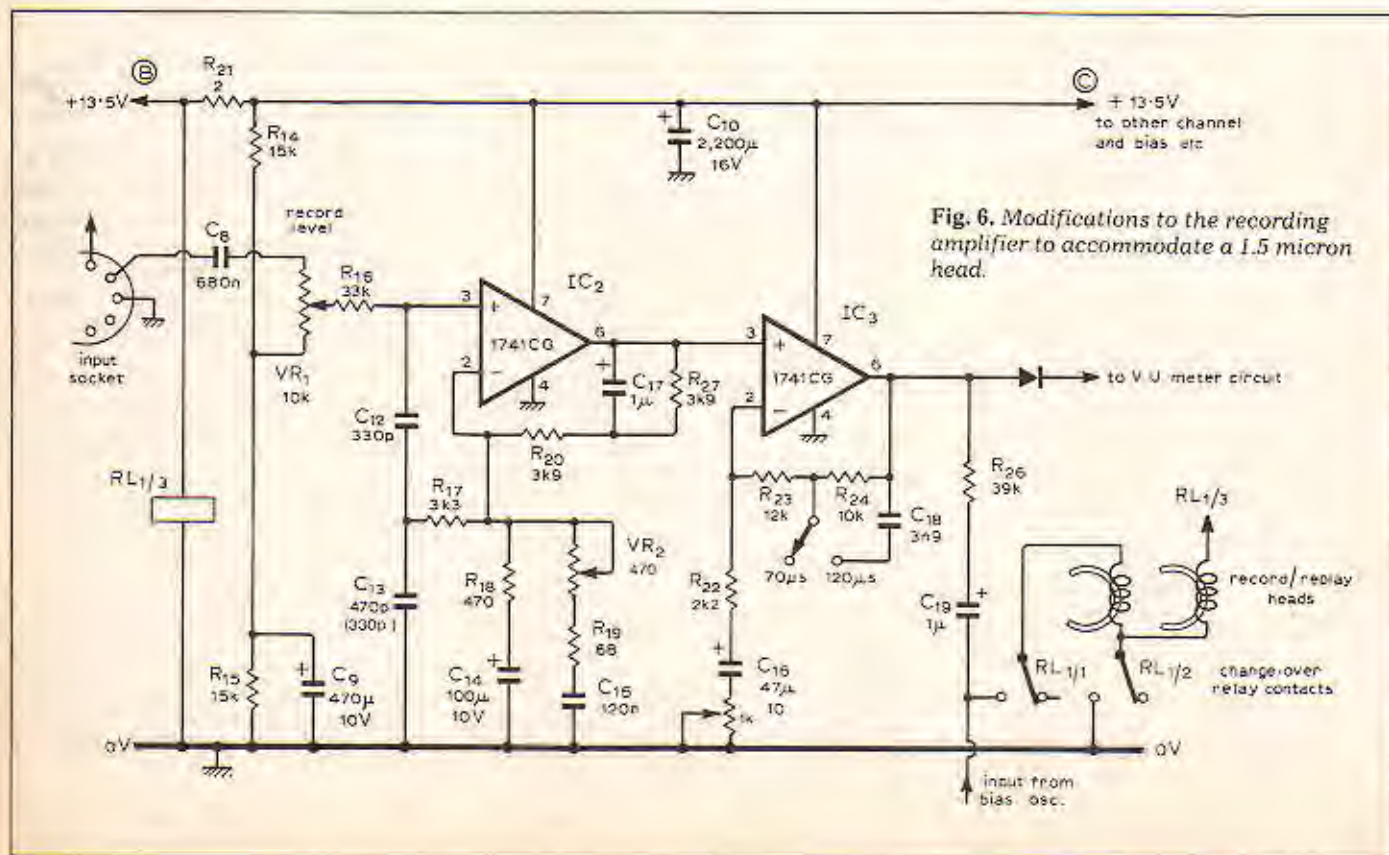

Fig. 6. Modifications to the recording amplifier to accommodate a 1.5 micron head.

geometry will allow, so that, if a greater input signal is impressed on the system, in the attempt to achieve improved h.f. response, the only likely effect will be to convert waveforms into a triangular shape, with a consequent increase in h.f. intermodulation distortion.

Hart Electronics of Oswestry have agreed to stock equivalent units to the Matsushita WY 436 AZ 1.5 micron head for those constructors interested in making the substitution.

Choice of h.f. bias frequency

The original choice of bias frequency (50kHz) was simply that of the recommendations of Garrard Ltd, the manufacturers of the original cassette recorder mechanism. There is a considerable tradition in the high-quality tape recorder field that the bias frequency should be at least five times greater than the highest intended recording frequency. This arises because the action of the bias waveform is effectively to sample the signal waveform at the bias frequency, and it is plausible that the desired waveform cannot be reconstructed accurately unless there is an adequate number of samples within one cycle of the highest required frequency.

However, experimental results obtained with differing bias frequencies – obtained by using differing values of C_{23} – show that on the tapes used the remanent recorded flux and hence the s/n ratio for a given recording level, decreases significantly as the bias frequency is increased to 60 or 75kHz, so that even though a wider bandwidth can be obtained with alternative head units a change in bias oscillator values is not recommended. Some support for retaining the original 50kHz bias frequency is given by the observation that some very high quality audio systems are based on sampling rates which are lower than this. For example, the current BBC f.m. stereo radio transmissions have an L-R sampling frequency of 38kHz; the digital encoding process, by which the p.c.m. signal is transmitted over cross-country land-lines, uses a 32kHz sample rate; and the very highly regarded Denon p.c.m. encoded gramophone recordings employ a sample rate of 47.25kHz. I accept the qualification that square-wave sampling and sine-wave biasing may not be equivalent and since a square bias waveform (in effect, a triangular current waveform) appears to work quite well I intend also to explore this approach.

Dubbing

If it is desired to 'over-dub' an existing recording, without erasing the existing material, this can be done by the use of a coil other than the existing erase head in the bias oscillator circuit, so that the erase head can be switched out of circuit. Although, in principle, any coil of suitable Q and an inductance of 1mH could be used for this purpose, the simplest approach is to use another,

similar, erase head, mounted in a convenient position remote from the deck and connected to a change-over switch.

Miscellaneous design oversights

It is, I suppose, inevitable, following the contemplation of a design for a couple of years, even without the benefit of criticism in print, that the designer will feel that there are certain aspects which could have been done better.

Gain adjustments. Apart from the changes in bias oscillator, feed capacitor and adjustment potentiometer value noted above, and the modifications to the replay circuit noise bandwidth limiting components, I feel I should have provided some means for adjustment of the relative channel sensitivities in the record and replay amplifiers, in order that the effects of component value errors could be removed. This can be done by making the lower feedback resistor, R_7 , in the replay amplifier variable over the range 820-1k8 ohms, in either one or both channels, which can be done conveniently by altering the value of R_7 to 820 ohms, and putting a 1k Ω preset pot. in series with this. A good quality unit such as a cermet type, should be used for this duty to avoid worsening the input noise level.

A similar relative gain adjustment can be made in the record amplifier if the value of R_{22} is reduced to 2k Ω , and a 1k Ω pot. is placed in series with it at the earthy end. This can then be used to set the relative record levels to equality at the l.f. (say 300Hz) end of the spectrum, as indicated on the meters – assuming that these have already been correctly calibrated – while the h.f. pre-emphasis trimmer pot., VR_2 , can be used to achieve record level balance between channels at the h.f. end (say 10kHz). These suggested changes are shown in Fig. 1 and Fig. 6.

Bias oscillator. In the bias oscillator circuit (the original Fig. 7) the lower potential divider capacitor in the Clapp oscillator (C_{21}) was shown as 2.2 μ F. With some erase heads, this did not give enough circuit gain to ensure that the oscillator would always operate. A 1 μ F capacitor in this position gives a greater tolerance of erase coil characteristics variations. This change was shown in the reprint* and is recommended for adoption in future units employing the original oscillator circuit design.

Meters. Some justified criticism has been received concerning the tendency of the recorded level meter needles to hit their limit stops on switch-on. This type of behaviour is difficult to avoid entirely, but it can be minimised, if necessary, by reducing the slightly over-generous value of the rectifier circuit series capacitor (C_{26}) from 10 μ F to 2 μ F.

Headphone amplifier. I also regret that

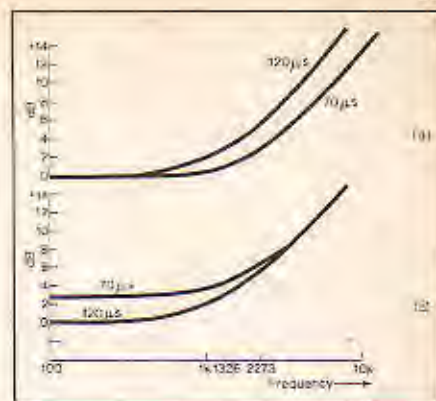

Fig. 7. Effect of recording pre-emphasis 'time-constants'.

the input p-n-p transistor in the Class A headphone amplifier was incorrectly labelled BC182L instead of BC212L. Any small-signal p-n-p device will serve, since its application is a very uncritical one.

Replay equalisation

Not entirely unexpectedly, I have come in for a certain amount of 'stick', both in correspondence and in the Letters columns, for my advocacy of the 70 μ s record/replay characteristic for general use. I note, however (with a certain amount of inward satisfaction, since it is nice occasionally to be right) that much of this has stemmed from a failure to understand just what the record/replay equalisation compensations are introduced for, or how they are derived. To shed a certain amount of extra light on what is obviously a somewhat shadowy area, I have appended a simplified analysis of the situation below, which can be omitted by those familiar with the subject.

In an ideal world of perfect magnetic tapes, and replay heads with complete external flux linkage and infinitesimally small pole-piece gaps, a tape could be recorded at all desired frequencies at a constant magnetic flux level, at some convenient value a little below the tape, or head, saturation level, and this would be found, on replay, to have generated an electrical output which increased linearly with increasing frequency, in such a manner that a doubling of frequency would cause a doubling of output, as defined by the classical laws of electromagnetic induction. A replay output which was constant, independent of frequency, could be obtained by a simple replay equalisation circuit which gave an output, starting at some conveniently low frequency, which decreased at a rate of -6dB/octave.

However, because of shortcomings in the tape and head characteristics, at the h.f. end of the recorded spectrum, it is customary to incorporate a degree of recording h.f. pre-emphasis, starting, in the case of the Phillips cassette system,

* High Fidelity Designs – a book of reprinted Wireless World articles on audio equipment construction.

at 1-2kHz. The actual pre-emphasis characteristics are defined by a specified time-constant, having the agreed values of 70 and 120 μ s. This can be converted into a known ± 3 dB point by the relationship $f = 1/2\pi CR = 1/2\pi \times \text{time const.}$ which gives +3dB values for the 70 and 120 μ s characteristics of 2273 and 1326Hz respectively, leading to the type of recording pre-emphasis characteristics shown in Fig. 7(a). If it is assumed that during recording the recorded signal levels are adjusted so that the recording level meters achieve the same recorded levels on peaks, and if it is assumed that this is mainly influenced by the greater signal level of the pre-emphasised region, the effective recorded level will, in reality, be that of Fig. 7(b). In the case of the 70 μ s characteristic, this assumes that the h.f. losses will be less, requiring less correction, and permits the recording of all frequencies below the 2.2kHz turnover point at about 3dB higher level than is the case for the 120 μ s characteristic.

If a similar characteristic were to be adopted on replay, the effect would be to arrest the downward slope of the replay characteristic at a turn-over point of 2273 or 1326Hz, beyond which the response would be level. In practice, however, the equalisation adopted is the recording one, and the replay characteristics are then corrected in the light of the experimentally derived replay-head/tape characteristics, so that the final record-replay frequency response is acceptably level. This usually involves some additional replay treble lift, to compensate for the finite replay-head gap width. The overall residual advantage is, therefore, due to the greater signal level in the mid-range frequency band, on the 70 μ s equalisation, due to the decision to adopt a lesser degree of h.f. boost, which gives about a 3dB benefit in terms of signal to noise ratio. Since tapes, and heads, are no less able to accept a given magnetic flux density at 300Hz than at 10kHz (in fact rather the converse), the imputation of a less satisfactory recorded distortion level due to this technique appears ill-conceived.

Technical inaccuracies

It is a matter of genuine concern in the preparation and publication of technical articles that inaccuracies of fact or terminology should be avoided. With the best will in the world, however, inadvertent errors do creep in, and, in the case of the original articles, there are three corrections I would like to make concerning the 'VU' nomenclature.

'VU' levels. If one constructs a piece of equipment which has signal level indicating instruments, which have calibrations ranging from -20 to +3, and which their manufacturers have labelled 'VU', then, so far as the signal levels indicated by these instruments are con-

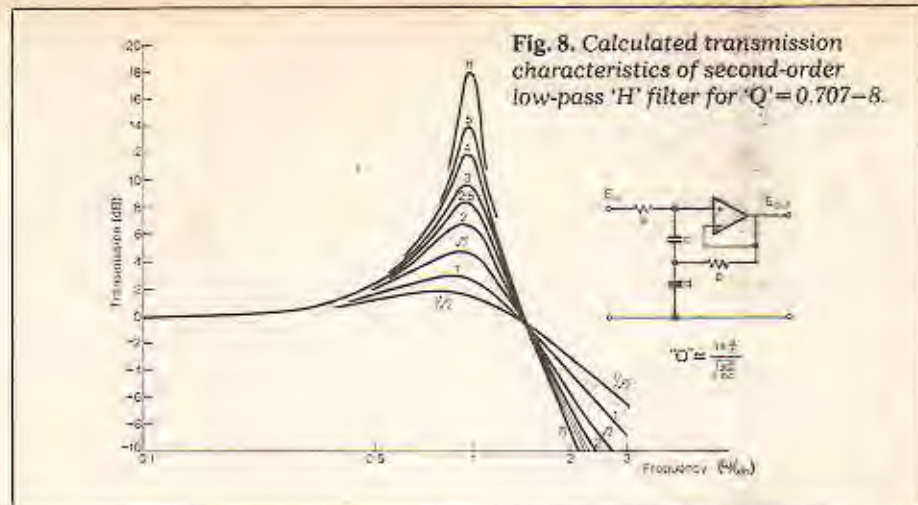

Fig. 8. Calculated transmission characteristics of second-order low-pass 'H' filter for 'Q' = 0.707-8.

cerned, one is rather in the position of Humpty Dumpty - "... when I use a word,' Humpty Dumpty said in a rather scornful tone, 'it means just what I choose it to mean, neither more nor less' ..." - so that although '0 VU' has a precise and specific meaning in the recording studio and sound engineering field (that of a signal level equivalent to 1 milliwatt in a 600 ohm load, or 0.775 volts r.m.s.) the '0' level on one's own instruments may, for practical reasons, be quite different from this.

Since I intended to redefine this level, for the purposes of this design, as being a level of 2.25 volts r.m.s., at 600Hz, as measured at the output of IC₃ in the record amplifier, it had been my intention, in the original article, to refer to VU levels, in this context, only within inverted commas, in order to indicate my temporary misuse of the definition. However, this I found, in print, that I had failed to do, and for this I apologise.*

Mr. Warren, writing from Australia,¹ did indeed reproach both *Wireless World* and me, respectively, for permitting and committing the solecism of referring to the recording level instruments as VU meters at all, in that this term should only be applied to instruments having certain, internationally agreed, standards of impedance, sensitivity and ballistic response, which the simple instruments I had described did not, and were not intended to, meet. I accept this rebuke, and am happy to substitute the somewhat more lengthy term 'recording level meter' for these display instruments. However, these strictures could be more widely spread, in that there are a large number of commercially available instruments which have signal level meters referred to as VU meters, which also fall a long way short of the international standards. While it is obviously desirable to prevent the corruption of specific descriptions by their careless use, I suspect that this particular case is

going to prove a difficult battle to win.

Finally, in describing the technique which I had adopted to generate the desired recording pre-emphasis characteristic, I showed a family of curves in my Fig. 15, as being typical of the type of response which would be generated by the use of an under-damped second-order low-pass filter, for various values of 'Q'. Although the mathematical derivation of the transmission characteristics of such filters is relatively straightforward, and in the case of the circuit which I used, is shown elsewhere,² the plotting of the frequency response, for various values of Q and frequency, is a laborious task in the absence of a suitable computer programme, so, since an illustration was required, I used that of the active lead + lag system, for which I had previously determined the frequency response characteristics, and which are similar to those of the system I had actually used, though not identical. It had been my intention, in the text, to make clear the fact that the curves were typical rather than actual. Mr Good³ has drawn my attention to my error in this, so, by way of penance, I have calculated the actual performance characteristics, and show these in Fig. 8. For convenience in calculation I define Q and 1/n in these graphs.

Because of the influence of the lag network, (VR₂, R₁₂ and C₁₃), on the operation of the circuit, the actual resonant frequency of the circuit is lower than the value calculated from R₁₅, R₁₇, C₁₂ and C₁₃, and decreases in frequency as well as increasing in magnitude, as the value of VR₂ + R₁₂ is reduced. This is a convenient characteristic from the point of view of suiting the h.f. equalisation peak response frequency to the characteristics of the heads in use, and is an additional reason for choosing this type of circuit in preference to the more conventional inductor based systems.

References

1. Warren, E. G., *Wireless World*, "Letters", p.46, Jan. 1977.
2. Linsley Hood, J. L., *Electronic Engineering*, July 1976, pp.55-58.
3. Good, E. F., Private communication.

* Examination of the original shows that Mr Linsley Hood did use quotes, in an excess of editorial zeal they were deleted - we are sorry for this. - P.R.D.

Reliability

Principles of reliability prediction and factors affecting the life of components

by H. R. Henly M.I.E.R.E.

Reliability is the responsibility of the engineer concerned with the design of a system or a sub-system, yet it seems to be one of the least understood concepts which he has to use. Engineers in general seem to prefer not to get involved in any calculations of the reliability of the equipment which they are designing. The reasons for this are probably a lack of understanding of the techniques involved — considered to be bordering on the "Black Arts" by some, and is probably largely due to the fact that the data used in reliability prediction has been derived statistically — and prediction infers crystal balls. But those who shudder at the thought of anything statistical should be reminded that even the value of a resistor is really a statistical statement and not an exact value.

MANY DESIGNERS will say "I don't need to do all those calculations. I design reliable equipment by using the best components". On the face of it this argument is quite sound, but it can only be at all valid in a situation where cost is of no consequence. Cost and reliability are closely related, and cost can be of equal, if not greater importance. There is also another aspect to be considered. The user of an equipment also has to maintain it. Nothing, however reliable, will work for ever and a prediction of failure rate is a useful indication of future maintenance effort required and likely store's holdings (today's components will not be available for ever, particularly in the rapidly developing world of electronics). These considerations may be of no importance where Grandma's portable telly is concerned, but it is a different story where a data-processing installation or a telephone exchange is concerned.

Certain aspects of reliability calculations can be a little involved. The object of this article is to present some of the fundamental ideas. Excellent works are available on the subject, of which references 1 and 2 are considered by the author to be the best.

What is reliability?

Every component, whether electronic, electro-mechanical or purely mechanical, has a finite life. After a certain period of operation there will be signs of deterioration in its performance until a point is reached where it no

longer performs satisfactorily. We then say that it has reached the end of its life. These last two sentences should pose some questions in the reader's mind. Such a definition is rather loose. Unless the device ceases to function completely, that which means failure for one application may not be so for another. Again, in a test situation where a device's parameters are being measured, the end-point of its life may be different to an application where negative feedback might mask the fall-off in performance to give an extended life. We can escape this quandary by recognising that the test situation has the advantage that it yields the more pessimistic estimate of device life and furthermore, that it is application-independent.

Reliability information comes from two main sources; the component manufacturer and the user. Firstly from the component manufacturer, and this applies mainly to active electronic components, e.g., semi-conductors. Batches of components are taken from the output of the production line according to a pre-determined sampling scheme. These components are placed on life-test during which they are exposed to various types and levels of stress, according to the specification of the device, and key parameters are monitored. When any of these parameters fall outside prescribed limits the component is deemed to have failed. The cause of failure is determined in order that the mechanism of failure can be better understood. In most cases this simple picture of life testing would be impracticable due to the length of life of most electronic components; reliability data would not be available in time for it to be of any use to the designer. For this reason, accelerated life testing is used. Considerable knowledge of the relationship between the life of a component and the temperature of operation, particularly in the case of semi-conductor components, has been accumulated. Thus by testing components at a suitably elevated temperature the life can be reduced to a lower, measurable value, and the component's life at other lower temperatures may be computed.

As stated above, the type of life testing conducted by component manufacturers is application-independent.

Furthermore, the test environment is closely controlled and the results which have been obtained over many thousands of device hours, enable the designer to predict the behaviour of his system even under different environmental and operational conditions. One possible draw-back with the reliability data produced by component manufacturers is that for economic reasons the number of devices of any one type that can be tested at a time is limited. Thus, it still requires a considerable length of time for the number of device-hours of testing for any particular component to reach the level required for the data to be statistically 'reliable'.

The second main source of reliability information comes from component users. In general most large organisations in the electronic and electro-mechanical sphere keep some record of the reliability of the components which they use. Some of the information may have been accumulated over many device-years and is therefore 'reliable'. These data are, however, extremely application-dependent and in the general case the published information drawn from these sources does not give details of environment, levels of stress, etc, under which the device concerned was operated. Indeed, the published information may in fact be the grand average of many different applications, etc.

This information is, in fact, very valuable. Because it is drawn from a very wide range of applications and operating conditions, it tends to present an average value and because in most cases the environment is not defined, the net result is very much more pessimistic than the data obtained from the manufacturer. Furthermore, because of the very much greater number of device-years encompassed in this type of information one may have more (statistical) confidence in it. Although the method of derivation of this information is the very antithesis of the scientific approach adopted by the manufacturer's quality control organization, i.e., it does not set out to separate and control or limit the many factors which affect reliability, this is, of course, far more typical of many industrial applications where little control can be exercised over, for example, environment. In many cases, particu-

larly with electro-mechanical components, this may be the only source of information.

Before pursuing the subject of component life data further and its application to the prediction of equipment life we should now look more closely at some of the terms used and how they are related. We have spoken, thus far rather loosely, of reliability, when most published data tends to be in terms of 'failure rate' and 'mean time between failures' (m.t.b.f.).

Since the behaviour of most physical systems follows some sort of exponential law it will come as no surprise to the reader that the probability of a failure occurring is also an exponential function of time. Reliability is the probability that a component will perform its function correctly for a given period of time under the specified operating conditions. The term probability is used here in its mathematical sense, where complete certainty that an event will occur is given the probability value 1 and complete certainty that the event will not occur is given the value zero. The probability of an event occurring must therefore always be between 0 and 1³.

We cannot simply consider the failure of a single component, since this is a single event in time: instead, we must consider what happens in the general case where a number of a given type of component operates in an equipment. If we plot the number of failures against time we get a curve similar to that of Fig 1 - often referred to as the 'bath-tub' curve. This curve has three distinct areas, the first being known as the burn-in period. During this time the number of failures is high and these are due to infant mortalities caused by component weaknesses, for example fragile leads, leakages in case seals, high leakage currents, etc. For electronic equipment this period is typically of the order of 200-300 hours and is not amenable to mathematical prediction.

At the end of the burn-in period the number of failures will have fallen to a low level and the failure rate - the number of failures per unit time - then remains sensibly constant for a very much longer period of time until the components near the end of their life,

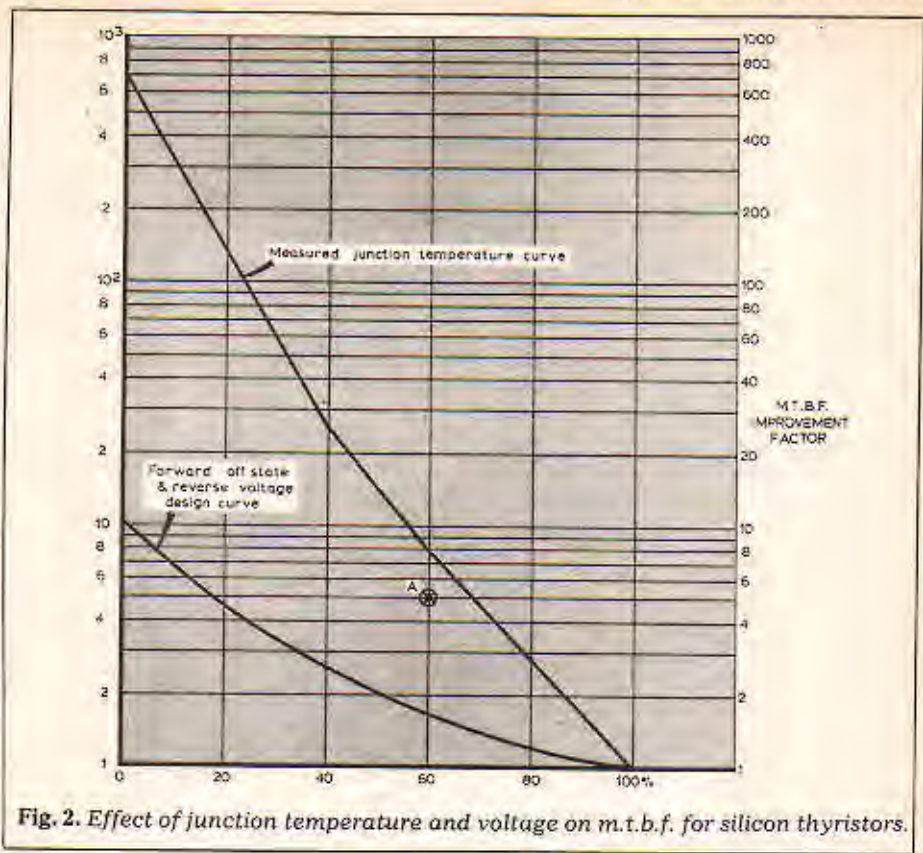

Fig. 2. Effect of junction temperature and voltage on m.t.b.f. for silicon thyristors.

the third area where the failure rate rises due to 'wear-out' failures.

In this article we are concerned primarily with electrical applications and of the above period that represents the useful life period. Failure studies have shown that in this period components tend to fail randomly with time and that the number of failures after a given operating time is exponentially related to time and the number of components in service. Thus: $N_t = N_0 e^{-t/m}$ (1) where N_t = number of failures after time t

N_0 = total number of the component in service and $e = 2.71828$, the base of Napierian logarithms.

The constant m was found to be the arithmetic average of the time to failure for the component concerned or m.t.b.f. Equation (1) can be rewritten in the more useful form:

$R(t) = N/N_0 = e^{-t/m}$ where $R(t)$ is the probability that the component will not fail within time t , (the probability of survival). In this form $R(t)$ ranges in value from 0 (zero probability of survival) for $t = \infty$ to 1 (complete certainty of survival) for $t = 0$. From the above equation, it will be seen that, in a similar fashion to the charge/discharge curve for a capacitor resistor circuit the controlling parameter is the 'time-constant' m . For example, for $t = m$, $R(t) = 0.37$. That is, the probability of survival for a time equal to the m.t.b.f. m is 0.37 (or 37%). The probability of survival for a time of $t = 0.2m$ is $R(t) = e^{-0.2m/m} = e^{-0.2} = 0.82$ or 82%. Conversely, we can find the value of t for which the probability of survival is, say, 98%. By taking logarithms we can rearrange the equation to give:

$t = m \log_e(1/R) = m \log_e(1/0.98) = 0.02m$
That is to say we can be 98% certain that the component or equipment will operate without failure for 0.02m hours. Alternatively one can use the last form of the equation in a similar way to find what the equipment m.t.b.f. must be to achieve a given survival time with the required level of confidence.

It is seen from the above that the probability of survival, that is, of operation without failure is determined by the parameter m , the m.t.b.f. It must be remembered that m.t.b.f. is, as the term implies, an average value - which in turn implies that there will be components whose time to failure will

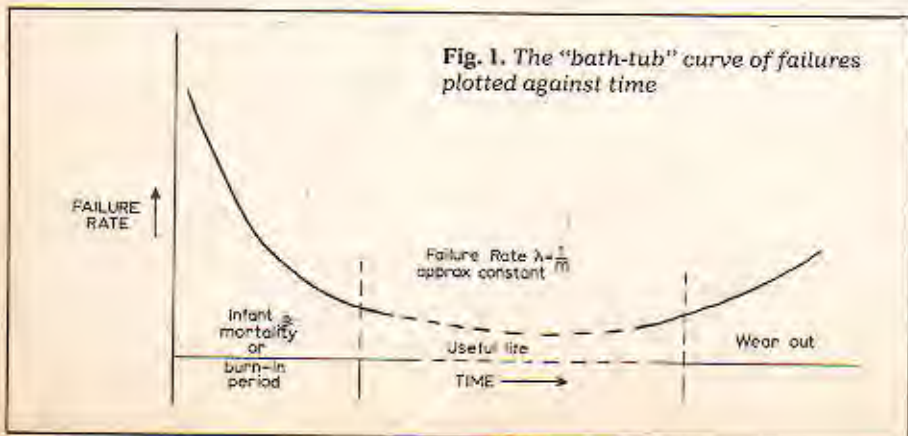

Fig. 1. The "bath-tub" curve of failures plotted against time

be less than m and also those whose time to failure will be greater than m . It is a common misconception that the m.t.b.f., m , when quoted for an equipment, is the life which one can expect before a failure occurs. As one can see from the survival equation, one can only be 37% certain that such a life will be achieved.

Failure rate, which we have already mentioned, is related to m.t.b.f. The average failure rate of a component is $\lambda = 1/m.t.b.f.$ or $1/m$ per unit time. If m is in hours then λ is failure rate/hour. Failure rate is usually expressed as the percentage component failures per 1000 hours. For example, in a data-processing installation, 500 integrated circuits of a particular type were in service for five years. In this time only two failures were recorded. The percentage failure was, therefore, $(2/500) \times 100 = 0.4\%$. The total number of operating hours was 43680 (5 yrs). Thus, failure rate = $(0.4/43680) \times 1000 = 0.0092\%/1000$ hours. This form is useful when comparing the performance of components, but must be converted to failures per unit time when performing failure rate calculations.

Equipment reliability

So far we have only considered what happens in the life of a single component or equipment. In practice we are concerned more with the reliability of equipment which contains numbers of different components and systems which comprise more than one equipment. These two cases are in many respects the same and what follows can be applied to both. However, the reliability of a system can be complicated by the presence of duplicate elements (redundancy) such that the failure of a single one of these elements will not result in failure of the equipment.

Since an equipment will contain numbers of components of varying types and individual reliabilities we would expect the overall reliability to be lower than that of the worst (least reliable) component. The relationship above gives the probability of a component's life extending to time t . If we have two components with individual probabilities of survival of $R_1(t)$ and $R_2(t)$ respectively, their joint probability of survival to time t will be $R_E(t) = R_1(t) \times R_2(t)$. If we substitute in this expression the exponential relationship for $R(t)$ we get:

$R_E(t) = \exp(-\lambda_1 t) \times \exp(-\lambda_2 t)$ where λ_1 and λ_2 are the failure rates of the two components.

Then $R_E(t) = \exp(-(\lambda_1 + \lambda_2)t) = \exp(-\lambda_E t)$. Clearly $\lambda_E = \lambda_1 + \lambda_2$, and the m.t.b.f. of the combination is $1/\lambda_E = 1/(\lambda_1 + \lambda_2)$. This leads to a very simple rule; to find the failure rate of an equipment in which failure of the equipment results from the failure of any one of the constituent components we simply add together the individual failure rates of all the components. For

Table 1. Component list of typical photo-electric system discussed as an example:

Component list for Photo-electric Beam Control Unit					
Section	Component	Quantity	Unit Failure Rate %/1000 hours	Joint Failure Rate %/1000 hours	
1. Amplifier	Resistors ¼w composition	20	0.021	0.0042	
	Capacitors: polystyrene	9	0.0008	0.0001	
	electrolytic	5	3.33	0.1665	
	Transistors low power 150mW	6	0.017	0.001	
	Diodes signal GaAs	1	0.008	0.00008	
	light source	2	0.02	0.0004	
	Soldered joints	120	0.18	0.216	
	Printed circuit board	1	0.01	0.0001	
	Output transformer	1	0.1	0.001	
	2. Relay Driver	Resistors composition ¼w	6	0.021	0.0013
		Capacitors polystyrene	3	0.0008	0.00002
		Transistors medium power	1	0.6	0.016
Diodes Zener		2	0.7	0.034	
Soldered Joints		30	0.18	0.054	
Printed circuit board		1	0.01	0.0001	
Relay (2 c/o contacts)		1	1.57	0.0157	
3. Power Supply		Power Transformer 100 VA	1	0.2	0.002
	Diodes power	4	0.7	0.028	
	Capacitors electrolytic	2	3.333	0.066	
	Power connector	1	0.005	0.00005	
	Soldered Joints	30	0.18	0.054	

example, let us consider the case of a simple photo-electric system in which a beam of modulated infra-red radiation is generated by a gallium arsenide diode and is detected by a silicon diode. A typical system with a self-contained mains power supply might contain the components shown in Table 1.

Summing the joint failure rates in the right-hand column of Table 1 yields the overall failure rates of 0.6605/1000 hours. The m.t.b.f. will therefore be $1000/0.6605 = 1514$ hours. Using the survival equation we see that we could only expect around 160 hours (with 90% confidence) of fault-free operation and this ignores, for example, failures due to the build-up of dust on the optical system. If this equipment were in use in a process-control installation with, say, nine other identical equipments and a failure of any one equipment would mean failure of the installation, then the overall failure rate would be ten times greater. The m.t.b.f. is therefore reduced to 151.4 hours. We could expect, with 90% confidence, a period of fault-free operation of only 16 hours.

Suppose that it is essential that the installation shall operate with 90% certainty for a minimum period of 22 hours without a failure. We can use the survival equation to find what overall m.t.b.f. is required; in this example we get m.t.b.f. = $22/\log_e(1/0.9) = 208.83$, say 209 hours. This requires that the m.t.b.f. of the individual equipments must be at least ten times this value — 2090 hours.

At this stage we might reasonably question the design of this unit and consider what improvements, if any, we can make to its reliability. The first step is to examine Table 1 to see how the failure rates are distributed over the different parts of the equipment. There are three distinct parts to this equipment; the photo-cell, light source and amplifier, the relay driver and the power supply. The joint failure rates and m.t.b.f.s for each are shown in Table 2.

TABLE 2
Approximate Distribution of Failure Rates

Item	Failure rate	mtbf hours
photo-cell light source and amplifier	0.3894	2568
relay driver	0.1211	8258
power supply	0.1501	6662

In this case the photo-cell, light source and amplifier contributes most to the unreliability of the system. One now has to decide whether any worthwhile improvements can be made.

The m.t.b.f. of the relay driver and power supply together is 3687 hours and this represents the highest m.t.b.f. which can be achieved — by reducing the failure rate of the amplifier to zero. Although this is not possible, this calculation does enable one to answer the question 'is any improvement likely to be significant?'. In this case, if the

amplifier failure rate were zero the m.t.b.f. of the system would be increased by a factor of 2.5. In practice, of course, we cannot expect to achieve such a vast improvement, but at least the scope is there. Had the ratio been much smaller, it is doubtful whether any practical improvement could be made which would be significant when compared with the rest of the system.

The two components with the highest failure rates are the electrolytic capacitors and the soldered joints. Provided the required values are not high the electrolytics can be replaced by Mylar film types with a unit failure of 0.0008%/1000 hours. This results in an overall m.t.b.f. for the amplifier of 4485. The overall m.t.b.f. for the equipment becomes 2023 hours; an improvement of 34%. The likely cost of this modification would be small, so a worthwhile improvement would be obtained.

As far as the other high failure rate component is concerned — the soldered joints — a significant reduction could only be achieved by a pro-rata reduction in the number of components. For example, if the amplifier could be replaced by two operational amplifiers in dual-in-line integrated packages, then the number of soldered joints would be reduced to about 60, but there would be a considerable reduction in the other components also. An estimate of the resulting failure rate (assuming the integrated circuits to each have failure rates of 0.0005%/1000 hours) is 0.1097/1000 hours. The resulting m.t.b.f. of the amplifier is therefore 9115 hours, and the overall m.t.b.f. of the equipment becomes 2625 hours, making the overall improvement due to both modifications about 1.7:1. This second modification is quite drastic however and would only be considered at the design stage of the equipment.

The time for which we could expect fault-free operation of ten units (with 90% confidence) is now increased to 27.7 hours. Clearly this is a considerable improvement but it is still hardly a satisfactory situation. In the original example we quote the case of ten such units, the failure of any one unit causing system failure. In such a situation we would be justified in looking for further improvements, but some of these may affect the design of the rest of the installation and would require careful consideration. Redesigning the relay driver to eliminate the relay, for example; although it would increase its intrinsic reliability, it would mean a drastic change in the interface with the rest of the system. Undoubtedly the power supply is another high failure rate area with its electrolytic capacitors and high power level devices. If the overall system design would permit, since 10 such photo-electric units are used, the use of a common power supply would make a significant change to the overall reliability. The joint m.t.b.f. for 10 units would become (assuming the improvements to the amplifier dis-

cussed above) 422 hours, nearly a 3:1 improvement over the original situation.

The above example serves to bring out one or two important points. The overall failure rate of an equipment will be greater, sometimes very much greater than that of any of the components used. Whether or not this overall failure rate is acceptable depends upon the system in which it is being used. Failure implies maintenance and calculation of the expected annual maintenance cost is often the best criterion for determining whether the expected failure rate is acceptable or not. It may seem a defeatist attitude to even consider that a failure rate could be acceptable but we must not lose sight of another factor — that the capital cost and the failure rates of components are closely related. For example, in the case of t.t.l. integrated circuits, when the costs and reliabilities of different packages are compared it is seen that by using Class A devices the cost is increased by a factor of 3:1 over that of industrial devices, whilst the m.t.b.f. is increased by a factor of 5.

Unfortunately there is no easy solution to this problem. A process of trial and error must invariably be used, employing a table similar to that of Table 1, but with an additional column giving the cost of each type of component, so that each component change will enable not only the effect upon reliability but also upon cost to be calculated. This table is inspected to identify those components which significantly affect the overall failure rate and alternative components and/or circuit redesign considered to improve the reliability bearing in mind the effect this might have on the overall capital cost. It may well pay to trade-off increased capital cost against reduced maintenance costs since the former is a 'once only' cost whereas the latter is a continuing cost.

It has already been remarked that failure rate of an equipment is not always due to complete failure of a component but instead is due to parameters varying with age and falling outside acceptable limits. It follows therefore that a positive contribution to reliability can be made by proper attention to equipment design. Electronic circuits should be designed to be as tolerant of component parameter variation as possible. Computer programmes are available which enable circuits to be simulated and the effect of component parameter variations to be accurately determined as well as power dissipations and stress levels. As well as making for a more reliable equipment these design techniques can lead to cheaper designs using wider tolerance components. The design of circuits which are tolerant of component parameter degradation is also very dependent upon the equipment performance specification. Performance specifications should not be unnecessarily tight

since this is immediately reflected in component tolerances.

Choice of components

The reliability of a component is determined by various factors and the degree to which these factors are operative in a given equipment must be decided by the equipment designer before an accurate assessment of reliability can be made. Some of the factors which affect the reliability of a component are:

- component quality and type of construction
- temperature
- vibration
- humidity
- electrical stress level.

Component manufacturers aim their products at various application fields and often have separate product lines for each — military and aero-space, industrial, domestic consumer, etc. Particularly in the semi-conductor industry the specifications for each of these fields are well defined. For example, in the case of t.t.l. integrated circuits the military product line differs from the industrial version in packaging as well as the performance testing to which the finished product is exposed (on a batch-sampling basis). There are significant differences in the reliability obtained but there are also equally significant differences in cost.

Capacitors are another example of a component field in which there are many types of construction. Here the constraints on the designer are not only cost and reliability but also physical size, maybe weight, and electrical performance. One may for example be faced with the quandary of requiring a silver-mica construction from stability considerations, a polystyrene in order to meet space requirements, etc.

The effect of temperature upon the life of a component may be judged in a qualitative fashion by remembering that the rate at which a chemical reaction takes place doubles for every 10°C rise in temperature. In general, electrical components show an increase in their useful life as their operating temperature is reduced. Fig. 2 shows the relationship between junction temperature and m.t.b.f. for silicon transistors.

At high temperatures other effects come into play which affect the mechanical structure of the device in addition to affecting its electrical operation; for example, thermo-plastics soften and distort at temperatures around 95°C, metal-glass seals rupture due to differential expansion and dielectrics change their characteristics. Under these conditions it is difficult also to maintain stable temperature levels and thermal run-away often occurs. For these reasons electronic equipment should be designed so that it operates well within the temperature ratings of its components with adequate ventilat-

ion to remove excess heat. In calculating the expected operating temperature of an equipment the effect of external sources of energy such as solar radiation should also be considered in addition to the expected range of ambient temperatures.

At the other extreme, operation of equipments at low temperatures can also adversely affect the life expectancy. For example, differential contraction of materials in seals, hardening of oils and grease in bearings. Complete failure of electrolytic capacitors, primary and secondary cells (except the Nickel-Cadmium type) in which the electrolyte has a very much lower freezing point than the lead-acid type.

Associated with the effects of operating temperature is the electrical stress level at which a component is operated. In the case of semi-conductors, reduction of the applied bias and operating current and voltage levels results in a significant increase in useful life. Tungsten filament lamps which typically have useful lives of some 2,000 hours at full rating, show an increase of up to five times this value for a derating of only 10%.

Closely associated with temperature is humidity. The absolute humidity is determined primarily by the air temperature and is highest at high temperatures and generally decreases with the temperature. Of all the various environmental factors humidity has probably the greatest effect upon component life, and performance. Absorption of moisture by a material used as a dielectric or just as an insulant causes an increase in loss angle with consequent local generation of heat and reduction in performance. Absorption also leads to dimensional changes, lowering of flexural strength and, over a period of time, corrosion of metallic parts, which is exacerbated by galvanic action where the contact of dissimilar metals is involved.

Any equipment which moves or in which there are moving parts will suffer vibration. The design of mechanical structures to minimise the effects of induced vibration upon the components is a complex exercise. To be carried out effectively the precise nature of the induced vibration in individual components must be known. In certain cases the effects of vibration may be alleviated by the use of anti-vibration mounts. Joints of all kinds and connectors are particularly vulnerable, as also are potentiometers, variable capacitors, switches, lamps and lamp-holders.

In this context particularly one must also consider the effects of maintenance work. This is one of many aspects of reliability where there is intersection with the subject of maintainability. In this particular case any component which may be moved in the course of testing may be subjected to damage.

For example, it is often necessary to remove printed circuit boards in order to mount them on extender boards or to

effect a repair. Apart from affecting the electrical contact between the mating contacts of the edge connector due to disturbance of dirt and oxidation layers — which should be cleared anyway before re-insertion — physical damage may also occur during the removal/replacement process. Careful selection of board connectors and design of their mounting plays an important part here. Similar problems arise where it is necessary to replace components. The quality of soldered joints must be controlled and the damaging effects to printed-circuit tracks and the board minimised.

It is, of course, an intractable problem as far as reliability is concerned to include the above and similar effects in any reliability equations at the design stage, unless one has available historical records for similar equipment operated and maintained under similar conditions. However, one is able at the design stage to design with the maintainability of the equipment in mind. The process whereby a faulty component is located should be made as direct as possible thus minimising the amount of speculative board removal and replacement for testing which otherwise occurs in practice.

It is not possible to consider these and other topics which affect reliability in greater detail within the scope of this paper. The subject is very adequately and explicitly dealt with in reference 2, which also goes a long way towards formulating the whole process of reliability calculations.

System reliability

Much of the foregoing discussion on equipment reliability applies also to system reliability. The system designer will be concerned with integrating a number of equipments into a complete system. When he has some control over the design of the individual equipments also, he will have the necessary data from which to assess the overall system reliability. A difficulty arises, however, with proprietary equipment, for example, a digital processor, where the system designer must rely to a large extent upon the information provided by the equipment supplier, weighted by any previous experience.

The system designer's work does not start when all the separate equipments comprising the system have been designed, it must start, before any detailed design can begin, with the complete specification of the system for which he must state the required minimum overall system performance objectives. These objectives must include minimum reliability and maximum cost boundaries. It would be super-idealistic to suggest that such boundaries can be fixed absolutely at this early point in the design but an initial feasibility study would indicate where they should be.

The overall design of a system from a reliability point of view requires more than the simple integration of a number

of component equipments and the calculation of the overall reliabilities. In the earlier example of a photo-electric system the reliability which was calculated referred only, in this case, to its electrical performance. In practice the system designer must consider the overall operation of the system. In this example, experience shows that in most industrial applications of photo-electric systems an important contributory factor to the un-reliability of the system, is the accumulation of dust on to the exposed optical surfaces. Prior knowledge of this factor could be taken into account in the design of the optical system and any recorded data relating to failure due to this cause used when calculating the expected m.t.b.f.

Furthermore, the remarks made above regarding the effects of maintenance work on the reliability of an equipment apply equally to a complete system. It is, therefore, equally imperative that the quality control of maintenance work should be at least, as vigorous as that employed at the manufacturing stage. This consideration together with the rising cost of maintenance for complex electronic systems has made the employment of centralised repair depots economically viable. First-line servicing is thus reduced to the task of identifying and replacing a faulty module.

References

1. Military Standardisation Handbook, Reliability Prediction of Electronic Equipment, MIL-HDBK 217B, US Dept. of Defence.
2. Electronics Reliability — Calculation and Design, G W A Dummer, and N B Griffin, Pergamon Press 1966.
3. Probability and Statistics for Engineers. Miller & Freund, Prentice Hall.

Paris components show travel arrangements

Readers of *Wireless World* can take advantage of special air travel and accommodation arrangements for the International Electronic Components Exhibition, Paris, April 3-8, made by our publishers, IPC Electrical-Electronic Press Ltd. Itinerary is: depart from London (Heathrow) Airport morning of April 3; return to London evening of April 5; stay in Hotel Meridien (de luxe) at Porte Maillot. Price, including breakfast, entrance to exhibition, services of tour manager and coach transport in Paris, is £120 per person (sharing twin-bedded room; single room supplement £23). Send to us for a booking form, which gives complete information.

Microwave hybrid integrated circuit technology

A review of microwave circuitry and systems progress

by R. Davies, Ph.D. and B. H. Newton, Ph.D., Mullard Research Laboratories, Redhill, Surrey

This article describes some of the processes and devices used in microwave hybrid integrated circuit (m.i.c.) technology and considers example m.i.c. subassemblies which are currently in use. Since m.i.c. technology has influenced only the lower portion of the microwave section of the electromagnetic frequency spectrum, which extends from 1 to 300GHz (30cm to 1mm wavelength), the following text is concerned only with circuits for frequencies between 1 and 40GHz.

WHILE INITIALLY almost dedicated to a radar role, microwaves now find applications in communications, scientific, industrial and even consumer activities. The attractions of microwaves are many and include broad bandwidth potential, spectrum availability, simple aerials with high gain and directivity and the existence of low sky noise at these frequencies. However, they were initially excluded from most applications as a result of the cost and complexity of the basic components. With the advent of solid state devices, capable of generation and amplification at microwave frequencies, the potential was very much increased. The devices were accompanied by basic technical advantages as well as the well known advantages of improved cost, size, weight and lifetime. For example, the complex global satellite communication systems now in existence depend for their viability on solid state, low-noise amplifiers.

Solid state microwave devices thus enabled microwaves to find new applications. The potential of microwave techniques was further enhanced when these solid state devices were combined with microwave components in hybrid m.i.c. subassemblies. These subassemblies are now making an impact at the production stage and we are finding that microwave techniques are becoming increasingly competitive in certain new fields. Traffic control, for example, is already an established area for microwave devices and systems, as illustrated by the traffic-light radar unit in Fig. 1. In the communications field, new subassemblies include those used in the experimental television receiver

systems which have been employed in Canada recently to receive 12GHz satellite transmissions. Another example m.i.c. assembly is the 12GHz-to-400MHz frequency converter shown in Fig. 2.

It is the object of this article to review the current status of subassemblies such as these in the light of device and circuit progress.

Developments and trends in microwave electronics

Microwave technology developed around vacuum tube devices such as triodes, klystrons, magnetrons and travelling wave tubes. Waveguide and coaxial techniques were fully compatible with these devices but resulted in large and expensive systems. The advent of microwave solid state devices offered the possibility of reliable, cheap and small components

for the generation, amplification and detection of microwave energy. However, solid state devices were incompatible with waveguide components and consequently their potential was reduced. The Gunn diode, for example, has dimensions of the order of microns, but until fairly recently it was packaged and mounted in a 3cm waveguide. Furthermore, waveguides have proved an unsatisfactory basis for miniaturisation.

The alternative, the coaxial transmission line, has an impedance level more compatible with that of semiconductor devices, but unfortunately it is not suitable for integration with semiconductor devices. A planar structure is desirable for this purpose. By distorting the coaxial line or the open transmission line, as indicated in Fig. 3, a range of miniaturised, open systems has evolved.

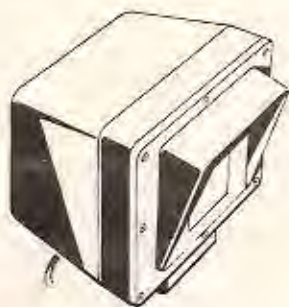

◀ Fig. 1. Traffic-light radar unit which uses microwave frequencies.



▼ Fig. 2. 12GHz-to-400MHz converter for satellite television.

Examples are triplate, coplanar waveguide and microslot, suspended microstrip (t.i.m.). Lumped elements have also found applications in the microwave frequency range^{1,2}. Although microstrip is often encountered, in combination with one of the other techniques, in subassemblies, we will concentrate on the microstrip technique since it is playing the major role at this time.

The microstrip structure supports a hybrid mode but it is permissible, at low microwave frequencies, to approximate its field configuration to that of a transverse electromagnetic (t.e.m.) mode. At these frequencies the transmission line properties can be derived by calculating the effective capacitance and inductance per unit length of the line by conformal mapping of the strip geometry³. Recently, microstrip structures have been constructed at frequencies beyond 12GHz where dispersion effects are significant⁴ and the t.e.m. representation is inadequate. Here the situation is far more complex and the hybrid structure must be solved. This problem has been the subject of substantial research effort and as a consequence it is now possible to design a complete range of passive circuit elements including impedance transformers, cavities, filters and directional couplers.

The microstrip configuration is suitable for accommodating semiconductor device chips either directly or on the supporting ground plane immediately adjacent to the substrate. Thus we have the possibility of hybrid, microwave integrated-circuit subassemblies. The realisation and performance of these components will

Table. Electrical properties of commonly used substrates

Material	Dielectric constant	Loss tangent
alumina	9.6	1.0×10^{-3}
fused quartz	3.78	1.2×10^{-4}
sapphire	9.3*	0.3×10^{-4}
	11.5**	0.9×10^{-4}
	*parallel to A axis	
	**parallel to C axis	
ferrite (e.g. Trans. Tech. G1021)	14.8	2.0×10^{-1}

be discussed in the remainder of this article.

Technology

As indicated in the introduction, a hybrid microwave integrated circuit consists of a number of semiconductor devices mounted either directly on or adjacent to a planar circuit. The planar circuit, commonly microstrip, consists of a metallic pattern, which defines the passive circuit elements on one surface of a dielectric substrate, the other side being completely covered by a metallic sheet.

Microstrip circuit patterns are commonly defined on 0.020in or 0.025in thick dielectric substrates. At frequencies in excess of 12GHz thinner substrates are sometimes used to suppress "surface wave" modes and

over-moding effects. However, careful circuit design can prevent the excitation of such modes on 0.025in alumina, even at 30 GHz⁵.

The basic process for manufacturing m.i.c.s consists of the following steps:

- substrate selection and processing
- complete metallisation of the substrate surfaces
- defining the circuit pattern
- a plating process to produce conductors of the correct thickness
- etching to remove the metallisation from the appropriate areas of the substrate
- mounting the semiconductor chips
- bonding and etching chips
- trimming the circuit components as required
- packaging
- passivation

It should be noted that processes (b), (c), (d) and (e) depend upon whether a thick or thin film metallisation is used. This will be discussed more fully later in the article.

The substrate

The substrate is selected on the basis of its low loss and high dielectric constant. A fine surface finish is also required to provide close circuit tolerances. A further significant parameter is the temperature dependence of the dielectric constant. The parameters of the basic substrate materials are summarised in the table shown.

Alumina is the most widely used substrate material. However, fused quartz is encountered where either fine definition or high frequency operation is required. Sapphire is sometimes employed, because of its high dielectric constant, to minimise the surface area. Ferrite substrates are used when non-reciprocal elements such as isolators and circulators are required, though the ferrite is often used in the form of a puck inserted in a dielectric substrate. Teflon and beryllia are also suitable for low loss substrates, and the latter is sometimes used to provide a high thermal conductivity (2.5W/cm°C). The use of beryllia, however, is very much restricted by its toxicity.

Alumina can be used in the "as fired" state and can be cut into appropriate sizes using a diamond saw or laser. Ultrasonic drilling can be used to drill holes in the substrate, and substrates can be thinned by a grinding process using diamond pastes.

Before metallisation, quartz and ferrite have to be polished using methods similar to those used for thinning alumina. Ferrite, however, requires some care, because intergranular holes may be formed

Fig. 3. Miniaturised microwave systems have evolved, as the drawings show, from coaxial or open transmission lines which have been distorted.

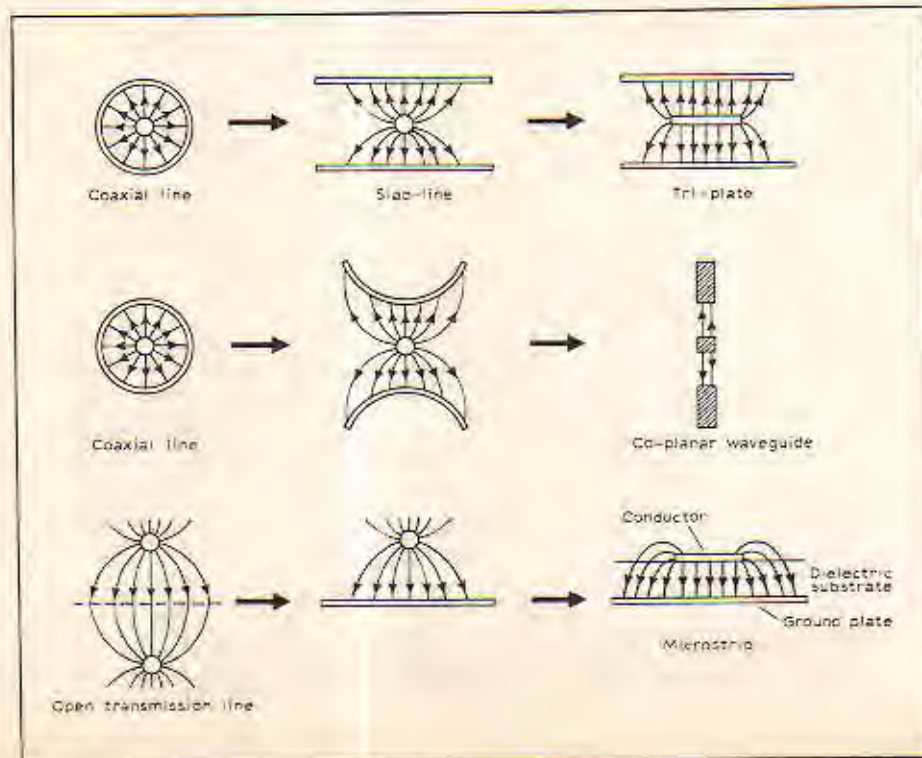
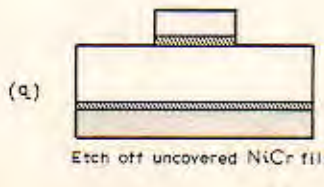
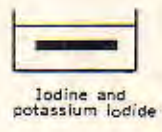
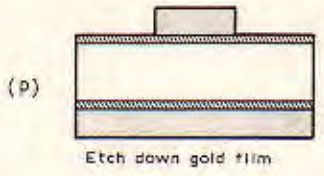
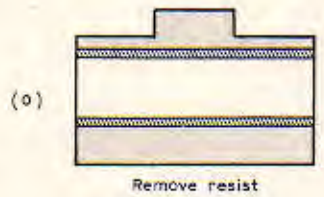
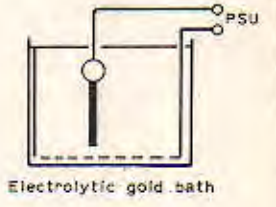
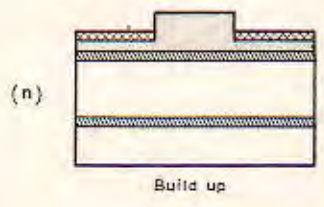
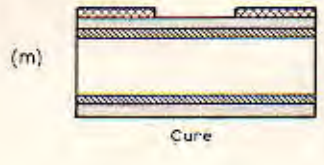
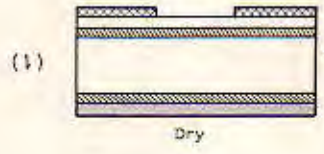
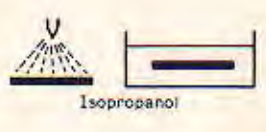
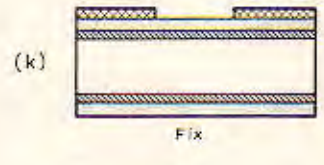
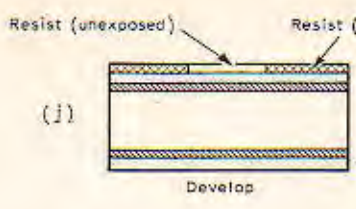
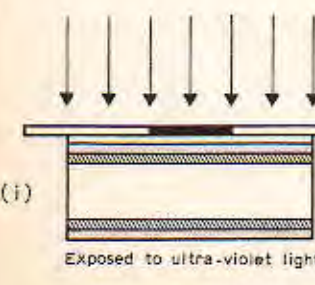
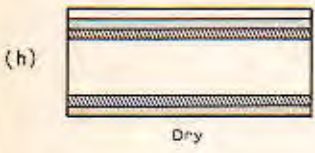
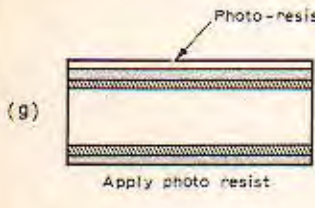
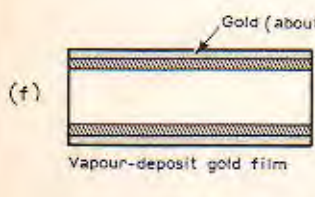
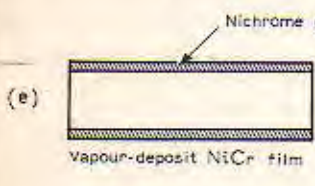
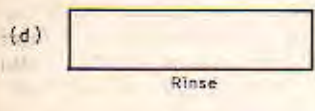
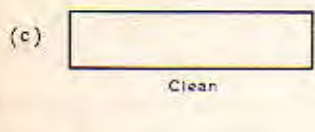
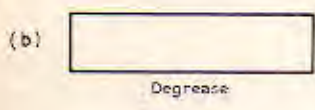
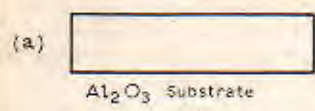

Fig. 4. This display of drawings shows the sequence of operations for forming a microwave circuit on a substrate.



during this process. Holes in the substrate of the order of $1\mu\text{m}$ to $2\mu\text{m}$ diameter would preclude circuits requiring fine geometry⁶.

Metallisation

The metallisation should provide low loss conductors which are firmly attached to the substrate. The conductors should resist corrosion and should be capable of receiving a bond wire attachment from semiconductor devices.

Two basic processes, thick-film and thin-film, are employed for metallising the substrate and producing the required conductor pattern. The thick film technique is simpler and potentially cheaper and consists essentially of a printing process. The conductors, in the form of ceramic inks, are extruded onto the ceramic substrate through fine silk or metal screens on which the required pattern is defined. The pattern is subsequently sintered at a high temperature (800°C). Circuits processed in this manner, however, lack definition and often have a loss which is too high for many applications^{7,8}.

The thin film process is most commonly encountered today because of the precision and low loss it offers.

Gold is generally used as the conducting metal because of its low electrical resistivity ($2.3\mu\Omega\text{-cm}$), high resistance to corrosion and compatibility with thermo-compression bonding. However, gold makes a weak bond to the substrate and a thin seed layer (about 200Å) of chromium, nichrome, titanium or tantalum is used to improve the adhesion. When resistive elements are required the nichrome-gold system is very attractive since resistors can be produced by exposing the nichrome seed layer.

Alternative conductor systems involving copper and aluminium have the advantage that they do not require a seed layer. Both metals, however, corrode rapidly to produce a mainly oxide layer which has to be removed before semiconductors can be attached. The metal layers are deposited, either by a vacuum evaporation or sputtering process, to a thickness of about 2000Å.

Resistive elements which are based on the nichrome-gold system and made by the evaporation technique, have improved stability due to the oxidation of the nichrome. This oxidation inhibits the diffusion of nichrome into the gold layer.

In dual metallisation systems the seed layer can diffuse into the gold layer, especially at elevated temperatures, and a barrier layer is often included. Platinum is most commonly used for this purpose but molybdenum and palladium are also employed.

Circuit definition

The required circuit is magnified twenty times and defined on a "cut and strip" film. The film consists of two layers of material, one optically transparent, the other opaque. A positive (or negative) of the pattern can be prepared by removing the appropriate section of the opaque layer. A mask is then prepared by photographic reduction. Computer aided design (c.a.d.) techniques are commonly applied to this part of the process. A computer, fed with the basic

component specification, generates a punched tape representing the circuit configuration. This tape is used to drive an automatic cutting machine to produce the desired pattern on the film material. The circuit pattern is transferred to the metallised substrate by the photolithographic process summarised in Fig. 4.

Devices

Currently, most semiconductor devices used in m.i.c. subassemblies are based on either silicon or gallium arsenide material. These devices are available for power generation and low noise amplification. As an example, state-of-the-art performance curves are given in Fig. 5.

Varactors, limiters, switching diodes, impatt and trapatt diodes and bipolar transistors are commonly constructed using silicon technology. Chips of these devices are mounted on the circuit and wire bonds are made to the various contacts. The chip is often mounted on the circuit by heating under ultrasonic abrasion. For this purpose it is not

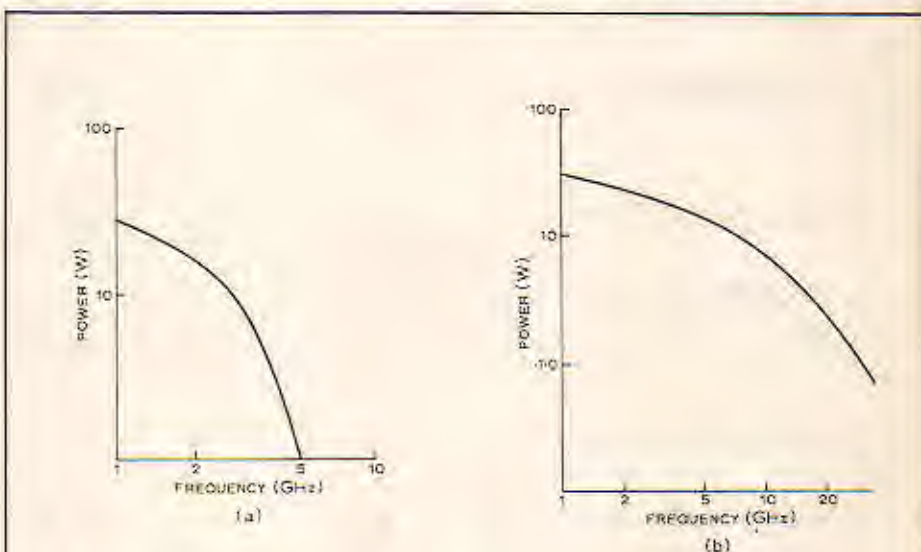
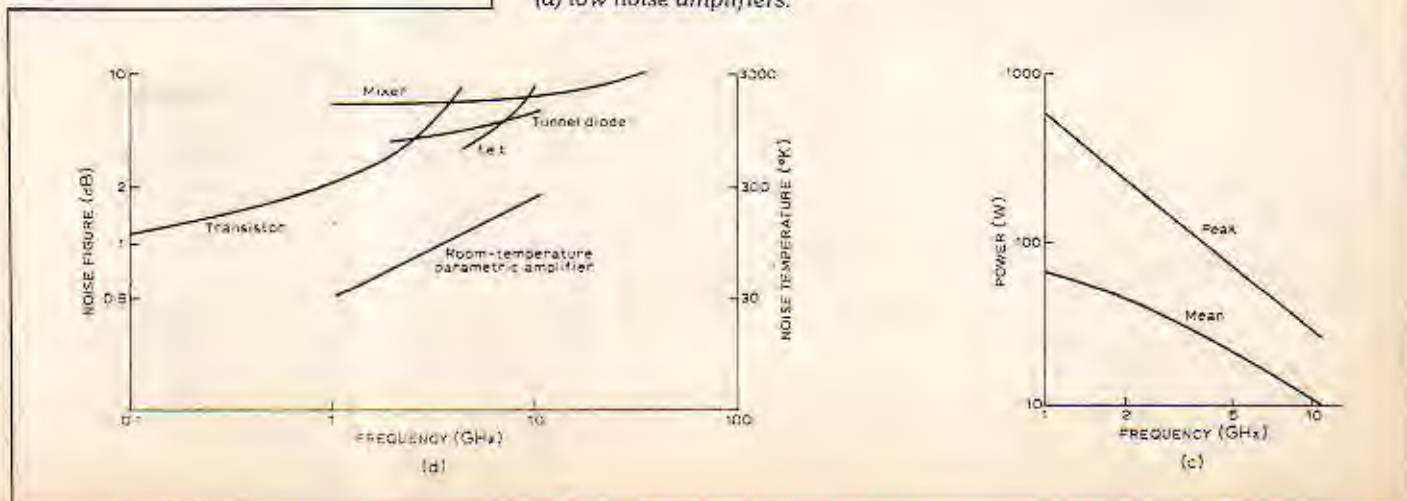

Fig. 5. Typical performance graphs for semiconductor devices now used in m.i.c. technology; (a) microwave power transistor, (b) impatt oscillator, (c) trapatt oscillator, (d) low noise amplifiers.



necessary to metallise the silicon if the surface of the mount is gold. A low resistance silicon-gold eutectic alloy is formed. The contacts on the other surface of the chip are suitable for thermocompression wire bonds.

Gunn and impatt diodes, f.e.t.s and high quality varactors are all based on gallium arsenide technology. Chips are usually mounted using a preformed gold-germanium alloy, and for this purpose the chip is metallised with gold. The upper contact is again compatible with thermocompression bonding and it is often gold metallised at the end of the process.

The process of alloying the semiconductor devices into microstrip circuits is very important. Poor alloying or contacting appears as a loss resistance in series with the device. Since the resistance of microwave devices is often very low, even a small loss can result in a considerably degraded performance. For example, an additional contact resistance of only 0.5Ω can double the noise temperature in a parametric amplifier application and reduce the efficiency from 40% to about 25% for an S-band trapatt oscillator.

The upper limit on the chip temperature is commonly taken to be 200°C . Chips for oscillators and amplifiers should therefore be connected to the heat reservoir via a low resistance path. Since the substrate is usually a poor thermal conductor, device chips are mounted directly on a gold-plated copper stud. Typical values of thermal resistance are in the range 10 to $100^\circ\text{C}/\text{W}$.

Packaging and protection

Semiconductor devices were initially mounted in sealed packages which were designed to minimise parasitic reactances and thermal resistances. They were small and expensive. Now unencapsulated semiconductor devices are, where possible, mounted directly in the circuit. Careful attention to the contact design and the use of silicon rubber compounds for passivation can result in simple, reliable subassemblies which can survive the environments applicable to the consumer market. For applications involving a wide temperature range the complete circuit is sealed. This involves the use of sealed r.f. connectors.

Examples of microwave integrated circuits

Five hybrid m.i.c. subassemblies, which employ the technology described above, are shown in Figs. 6 to 10. These examples are selected to demonstrate that simple circuits can perform adequately for systems applications. They extend from simple oscillators to fairly complex subassemblies.

Figure 6 shows an X-band varactor-tuned Gunn oscillator. The circuit is constructed on a ferrite substrate and

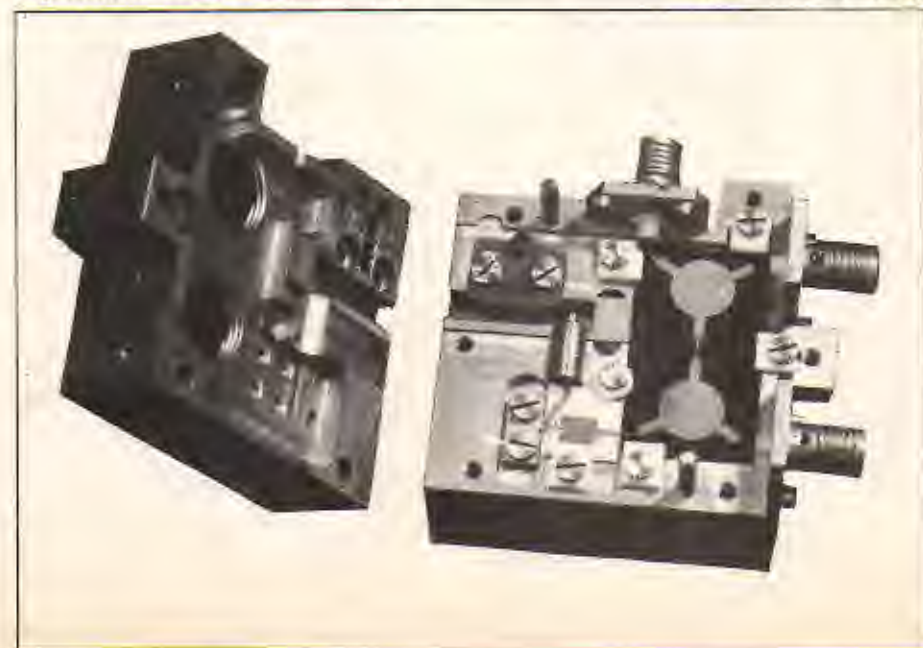

Fig. 6. An X-band Gunn oscillator on a ferrite substrate.



Fig. 7. An X-band Doppler module on a ferrite substrate.

Fig. 8. An X-band parametric amplifier.



includes a circulator to provide output isolation. The Gunn diode chip is mounted on a gold tab to minimise the thermal resistance. It is series resonated by the wire which connects between the chip contact and the circuit and a varactor diode chip. The necessary temperature stability is achieved by coupling the circuit to a microstrip resonator.

The performance figures for the oscillator are as follows. The power, voltage and current ratings are 10mW, 8V and 100mA respectively. It has a centre frequency of 9.4GHz, an electronic tuning range (e.t.r.) of 100MHz and it requires a tuning voltage from 2 to 6V. Over the e.t.r. the temperature stability is $1\text{MHz}/^\circ\text{C}$.

Figure 7 is a simple Doppler radar module which is essentially an extension of the varactor tuned oscillator. A detector diode is mounted on the third port of the circulator and the transmitted and received frequencies are permitted to mix within this device. The unit shown is in the final stages of development and indicates the practicality of the m.i.c. approach.

Figure 8 is a photograph of a parametric amplifier⁹. This unit indicates the problems of applying hybrid techniques to components which involve a wide frequency range. Under such conditions it is necessary to use multiple substrates, and these may still be combined with waveguide technology at frequencies around 40GHz.

Figure 9 illustrates a subassembly which combines the microwave circuit (consisting of a Gunn local oscillator, similar to that in Fig. 6, and a double balanced mixer, on alumina) with two i.f. amplifiers. Chip capacitors and integrated resistors are used in this assembly. Figure 10, however, shows a 900MHz transistor amplifier in which all components are fully integrated on the

continued on page 57

CITIZENS' BAND

IN response to correspondence on the subject of the allocation of a small part of the radio spectrum for citizen use I received a reply from the Radio Regulatory Department of the Home Office which stated that, "the Government has announced that the disadvantages outweigh the advantages and that it has no intention of introducing citizens' radio in the UK."

It would seem that the official attitude has now hardened and the Government and its advisers have been unimpressed by arguments based on possible uses in accidents and disasters and more impressed by reports of misuse in USA, problems of regulation, interference to other users and services and possible frustration of law enforcement efforts. The citizens' band lobby appears to have failed and supporters will now have to consider whether to accept the official line or to increase political pressure upon MPs.

W. G. C. Austin
Newcastle upon Tyne

Editor's note: At least the electronics industry has not given up hope. A working party of the Electronic Engineering Association (March 1976 issue, letters, p. 61) has recently made an interim report on the possible introduction of CB in the UK, and in this has considered the scope of the service, how it will be licensed, how the equipment will be approved for use, and the standards to which the equipment will be designed and manufactured. It seems the manufacturers are ready if and when the Government changes its mind.

AMATEURS' POWER LEVELS

I REALLY must take issue with the greatly over-estimated power levels quoted by your correspondent Pat Hawker in his December issue "World of Amateur Radio". I am at a loss to understand how he can possibly infer powers of 50-100kW e.r.p. as being typical of those used on 432MHz. Even if an amateur does manage to achieve 400W output at this frequency, which is doubtful, he will have to face at least 2dB, and probably more, loss in the coaxial cable feeding the antenna. This will bring his power at the antenna to around 200W. Many antennae have over-estimated gain figures and a fair estimate of the highest gain aerial being used regularly in the London area would have approximately 17dB gain. The e.r.p. would, thus, be about 10kW. To infer an output power of 100kW would suggest an installation having 27dB gain which, frankly, is preposterous at this frequency.

The limitation of British amateurs to an input of 150W d.c. power is highly misleading since, assuming a class C efficiency producing an output of 100W carrier, when fully modulated with a.m. the output, in fact, becomes 400W p.e.p., identical to the maximum equivalent peak envelope power allowed for s.s.b. In many countries there is far greater legislation against manufacturers forcing them to produce adequate filtering to stop domestic tv sets from picking up frequencies that they are not theoretically licensed to receive. I must insist that domestic tv and radio equipment must have the same components fitted as are supplied in sets produced for the German market, for



example. Whilst I agree with a.m. and f.m. being limited in the way that it is already, I see no reason why the rating for c.w. should not be the same as for s.s.b.

I will admit that I have gone to extremes in my own v.h.f./u.h.f. installation and by using cable that is extremely expensive can produce an absolute maximum of around 12kW e.r.p. on 432MHz. While being a long way short of Pat Hawker's 100kW, this is adequate for my purposes but only just sufficient for specialised DX working, which is my primary interest.

As Public Relations Officer of the UK FM Group (London) I wish to state categorically that there has never been any decision by any committee member or by the committee in general even to consider closing down the London GB3LO 2m repeater. I must assume that Mr Hawker had foreknowledge of a forged letter sent to the RSGB and not to him. I must criticise his making use of information in a letter which was not authenticated. The November issue of the RSGB magazine *Radio Communication* deals with the matter at length, but please rest assured that the opinions of the UK FM Group (London) are most certainly to press for more repeaters on 2m in the London area, preferably a further three.

Finally, as far as aerial heights are concerned, many tests have been made at different power levels and heights and it is clear that for repeaters to have an adequate coverage when used by mobile stations, heights of 100-300ft above ground level are essential if transmissions are to be received adequately under all traffic and obstacle conditions. The present heights employed by repeaters are ideal for the purpose and in no way are they causing interference other than relaying that produced by unlicensed pirate operators whom the Post Office seem to be either unprepared or unable to locate and prosecute. Over 99% of regular users of repeaters behave as one would expect of them, and it is most undemocratic to think of closing down any forms of amateur radio transmissions because of the extremely small minority of vandal operators. Perhaps next, someone might suggest doing away with telephone boxes, in order to stop financial losses through their vandalism.

Angus A. McKenzie G3DSS
Angus McKenzie Facilities Ltd
London, N3

Pat Hawker comments: To keep it short: I did not say a maximum of 50-100 kW e.r.p. was "typical" on u.h.f.; nor did I infer it was even feasible in the UK with legally-rated transmitters. I agree that only a few amateurs

currently exceed about 10kW e.r.p. on 432MHz. But does Angus McKenzie deny that some amplifiers in current use are capable under two-tone or speech conditions of up to say 800W p.e.p. (not average) output? A transmission line loss of 1-2 dB may be difficult to achieve at u.h.f. but is feasible; similarly an aerial power gain of 20 or 21 dB. I make that a maximum of about 50 to 80kW (peak) e.r.p. So is "50-100 kW" greatly over-estimated?

I find it difficult to take seriously the suggestion that I had "foreknowledge" of, or used unethically, that forged letter. I, like others, was misled — but, then, only a few months before I had reported a statement by the chairman of the UK FM Group London that "some of the things I hear through GB3LO make me ashamed to be associated with it. There have been suggestions that GB3LO should be closed down completely, and more specifically that it should be closed in the evenings". That hardly squares with Angus McKenzie's categorical statement. Through no fault of the UK FM Group (or the RSGB) GB3LO has undoubtedly gravely damaged the reputation of amateur radio in this country. If it cannot be cleaned up, it will eventually be closed down, fairly or unfairly.

GEOMAGNETIC SENSE IN BIRDS

MR WHATWORTH'S proposal (December, 1977, letters) that wing movement may be a basis for geomagnetic sense in birds is most interesting. However, any general model of such a magnetic sense should consider two facts. First is the relatively large current flows produced in tissues by muscular activity and second is the remarkable behaviour of the Emperor Penguin.

Co-ordinated muscular activity may produce potential gradients in the skin of more than 100 microvolts per millimetre due to current flow from the active muscles into the tissues around them. Some mechanism would need to be postulated, therefore, capable of separating any signals produced by wing movement in a magnetic field from the potential difference produced by the muscles which move the wings. The currents associated with muscular contraction are several orders of magnitude larger than those generated in Mr Whatworth's model and both would be highly correlated with wing movement.

The Emperor Penguin breeds interalia in a rookery near Halley Bay in Antarctica. The position of the rookery appears to be constantly related to a major geomagnetic anomaly. The location is on the winter sea ice close to the cliffs of the Brunt ice shelf. The topography of the cliffs and their distance from the anomaly is variable from year to year as icebergs calve during the summer months. The birds have no constant visual reference for the annual relocation of the rookery.

When breeding, one of the pair travels from the rookery to the edge of the ice, about 100 miles away, to feed on fish. It then returns to the rookery to feed the chick on the products of the stored food. This remarkable journey is made by walking or sliding but never by flying. The penguins' fore limbs are highly adapted for swimming but are useless for flying.

If, as seems possible, the Emperor Penguin navigates to its rookery by a magnetic sense

and the local peculiarities of the earth's magnetic field, then it must either have an extraordinary differential sensitivity to any e.m.f. produced by movement of its small flippers, or some different type of mechanism must be considered.

J. D. Dawson
British Medical Association
and
G. D. Dawson
University College, London

DISTORTION IN LOW-NOISE AMPLIFIERS

IN his otherwise informative article on distortion in transistor amplifiers (August 1977 issue), Mr Taylor is incorrect in stating that the equation

$$\exp \left[\frac{eV}{KT} \cos \omega t \right] = a_0 + a_1 \cos \omega t + a_2 \cos 2\omega t + \dots \quad (1)$$

cannot be solved analytically. The required mathematical identity is^(1,2)

$$\exp(\lambda \cos \theta) = I_0(\lambda) + 2 \sum_{n=1}^{\infty} I_n(\lambda) \cos(n\theta) \quad (2)$$

where the coefficients $I_n(\lambda)$ are n^{th} order, modified Bessel functions whose values may be found in standard tables^(2,3). Thus the amplitude of the n^{th} harmonic relative to the fundamental is given by

$$A_n/A_1 = I_n \left(\frac{eV}{KT} \right) / I_1 \left(\frac{eV}{KT} \right) = \frac{1}{n!} \left(\frac{eV}{2KT} \right)^{n-1} \quad (3)$$

where the last expression is an approximation, correct for small values of eV/KT . The exact value of t.h.d. may be easily calculated since successive coefficients are of rapidly decreasing value.

However, for approximate calculations neither tables nor computers are required. Equation (3) shows that the second harmonic distortion level in per-cent is roughly given by

$$D_2 = \frac{100}{2} \left(\frac{eV}{2KT} \right) = 25 \frac{eV}{KT} \quad (\%) \quad (4)$$

Further, since the t.h.d. is predominantly second harmonic, and since KT/e is 0.025 volts at room temperature, we find the remarkably simple numerical approximation.

$$D = V \quad (5)$$

where D is the t.h.d. in percent and V the base drive in millivolts. As Mr Taylor noticed from his numerical calculations, the distortion is 1% at 1mV drive and is 10% at 10mV!

To see the degree of approximation involved, the accompanying figure compares

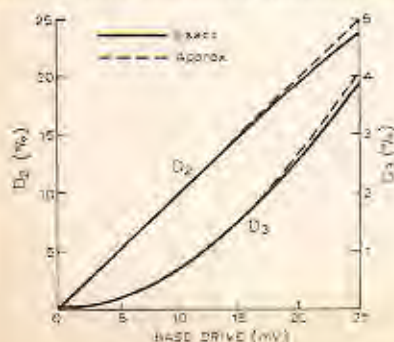

the approximate and exact values of the second and third harmonic components D_2 and D_3 (note different scales) using equation (3). One can show numerically that the t.h.d. curve lies between the exact and approximate D_2 curves. Thus equation (5) is accurate to 1% up to 15mV base drive and is less than 3% high at 25mV.

P. D. Edgley
Department of Engineering Science
University of Oxford

References

1. G. N. Watson, A treatise on the theory of Bessel functions, 2nd ed., 1958, (Cambridge University Press).
2. M. Abramowitz and I. A. Stegun, Handbook of Mathematical functions (Dover Publications).
3. British Associates for the Advancement of Science, Bessel functions, Mathematical Tables Vol. VI (1950) and Vol. X (1952), Cambridge University Press.

Dr Taylor replies:

It is evident from Mr Edgley's letter that I should have been more cautious in my choice of words when I stated that the Fourier Series expansion for the exponential base-emitter characteristic of a transistor could not be solved analytically. Mr Edgley is quite correct in pointing out that a table of modified Bessel Functions allows an analytical solution. Unfortunately it is normally necessary to resort to recurrence relations to determine the higher order functions (see for example Mr Edgley's ref. 2) and again the solution becomes laborious. The repetitive nature of the calculations to determine t.h.d. as a function of input signal amplitude is ideally suited to a numerical computing technique which, with a minor programme modification, also allows the distortion performance of the long tailed pair input stage to be calculated.

I would now like to reply to the comments made by Mr Dytch and Mr Bishop in their letter in the November 1977 issue.

When the design of this pre-amplifier was initiated some time ago I consulted a well known cartridge manufacturer to determine whether the input bias current would damage the cartridge and was informed that it would not. It seems unlikely that 100nA of bias current will have any effect on the performance of a magnetic cartridge and recently Shure have been kind enough to conduct tests with their V15 Mk III cartridge and confirm that this in fact so. If however the amplifier is adapted for use with a moving-coil cartridge it would perhaps be advisable to a.c. couple the input to prevent damage to the cartridge.

I have received some correspondence concerning the accuracy of the RIAA equalisation, typically -2.5 dB at 20Hz and +2.5dB at 20kHz with my original circuit. The discrepancy at low frequencies is primarily due to the 10μF capacitor and 1kΩ resistor in the input circuitry giving a low frequency roll off at 16Hz. Increasing the capacitor to 47μF brings the equalisation to within 1.0dB of the RIAA characteristic with the preferred values of components used in the equalisation network. Correct high frequency equalisation of a series feedback pre-amplifier presents certain problems because it is not possible to obtain a gain of less than unity. These problems become more severe as the sensitivity is reduced and therefore, for a particular amplifier design, the accuracy of equalisation is related to the

overload capability. The high frequency equalisation of my original circuit can be improved, however, to within 1.0dB of the RIAA characteristic at 20kHz by shorting out R_1 and increasing C_1 to 75pF to maintain closed loop stability. As yet I have not made any measurements with this circuit modification but cannot see any reason why it should significantly effect the distortion performance of the amplifier.
Eric F. Taylor.

DIRECT SENSING OF RADIO WAVES?

MR DONALD WOOD, who writes in the December issue concerning the direct perception of electromagnetic waves, might be interested to learn of some experiments carried out by A. F. Collins in 1902. These were aimed at verifying "the casual observations long since made that approaching electrical storms manifested their presence in persons afflicted with certain forms of nervousness and other pathological conditions, though the storm influencing them might be many miles beyond, or even below, the horizon. To accomplish this task it was necessary, of course, to decide conclusively that electric waves exercised some behaviour or produced a change, molecular or otherwise, on the brain cells."

Collins' technique was to insert two electrodes into the brain to see if it would act as a "coherer" - i.e. to search for a decrease in resistance under the influence of electromagnetic radiation. He experimented initially with a dead mammalian brain obtained from a slaughter-house, and with the brain of a live cat which, in Collins' own words, "willingly lent itself to the subject for the investigations to be made on brain matter in the living state". Coherence was obtained, and also some twitching of the base of the brain was seen in response to the application of the electromagnetic stimulus.

Encouraged by these results, he repeated the experiments on a human brain from a recently deceased person, and found that the rust-red material in the cerebellum showed the greatest response. Finally, he carried out some measurements of resistance to determine the effect of 24 hours brain deterioration, but found that his instruments were behaving very erratically, the galvanometer needle jumping all over the scale. "This state continued for a few minutes, when a peal of thunder awaked me to the actual cause. A storm was approaching... As the storm approached, the deflections grew more and more pronounced, the needle quivering at either end of the scale alternately as though endowed with life. The very phenomenon I sought to verify with a 2cm spark coil was here produced by the lightning itself... In these tests I was favoured with circumstances which, with me, might never occur again, for the reason that a fresh human brain was necessary, and that an electrical storm should be in progress when all was in readiness was quite remarkable".

Some other relevant remarks were made by the editor of the journal *The Electrician* in 1913. He was commenting on the experiments performed by Prof. Lefeuve of Rennes,^(1,2) and verified by H. R. B. Hickman.⁽³⁾ In these, the sciatic nerve of a frog's leg was connected to an aerial (via a rectifier) and to earth. The incoming c.w. telegraphy signals were then read from the Galvanic twitchings

of the frog's leg. The editor wrote, "Perhaps those who write 'scientific' articles for our daily contemporaries will see in this an explanation of the twitchings which some folk feel at the approach of a thunderstorm. But it occurs to us that oscillatory current cannot in fact affect nerves and muscles, for it is cold, then in spite of the 'skin effect' the neighbourhood of a large wireless telegraph station would be full of votaries of St Vitus during the despatch of a message."

V. J. Phillips
Sketty
Swansea

References

1. A. F. Collins *Electrical World and Engineer*, vol 39, No. 8, Feb. 22, 1902, p. 335.
2. *Electrician*, vol. 71, 1913, p. 93.
3. J. A. Fleming, "Principles of electric wave telegraphy and telephony", (Longmans), 3rd ed., 1916, p. 540.
4. A. Gradenwitz, *Electrical Review*, vol. 71, No. 1826, Nov. 22, 1912, p. 820.
5. H. R. B. Hickman, *Electrician*, vol. 71, 1913, p. 143.
6. *Electrician*, vol. 71, 1913, p. 81.

MOBILE RADIO SPECTRUM UTILISATION

YOUR article "Home Office sifts WARC Evidence" in the October 1977 issue highlights a number of interesting points. Prominent among them are the views of an American manufacturer in which (a) they see mobile radio development moving towards the use of digital techniques and (b) they consider any channel bandwidth of less than 25kHz as a backward step. One infers from the text that the two points are linked.

Undoubtedly trends in the evolution of mobile radio indicate that certain types of user, in particular those users requiring security and speed of communication on a large scale, will, during the next decade, move towards the use of new techniques in which digital methods will form a major role. Three points, however, emerge:

- Conventional speech methods will undoubtedly still remain the prime mode of communication for many years to come — in particular with the small user.
- The transmission by radio of high speed data, digital speech etc. is still in a relatively early stage of development.
- Indications are that the digital methods are currently wasteful in the use of frequency spectrum. Consequently doubt must be expressed as to the wisdom of allocating a common channel bandwidth standard, adequate to accommodate today's digital communication systems, but considerably in excess of that accepted as adequate for transmitting speech or slow speed data intelligently.

It seems likely that future developments of digital techniques will produce methods capable of operation in reduced bandwidths; it may however be wrong to base *all* channel allocations at this time on such a possibility. However, I believe that a more realistic approach would be to divide the available spectrum into channel units suitable for conventional speech communication — 12½kHz for example — and, where a need for a channel of wider bandwidth is justified, to combine the use of two or more adjacent channel units for the purpose. By this method, subsequent changes to spectrum

planning, brought about by a reduction in bandwidth needs as development proceeds, could be implemented by merely adding other users in the vacated slots.

Certainly the use of digital techniques — high speed data, digital speech etc. — will grow, but it is anticipated that by the time more users, large or small, need to employ such techniques, the state of the art may well be sufficiently advanced as to require a totally different approach to spectrum planning.

W. M. Pannell
Stapleford
Cambridgeshire

Editor's note: Mr Pannell is the principal author of the "Pannell report" on private mobile radio issued by Pye Telecommunications last year (see February 1977 issue, p.31).

TUMOUR ERADICATION BY R.F.

THE paragraph in Pat Hawker's column in the November, 1977, issue reminded me of some experiments I conducted when working on the ionophone project at Plessey in the early 'fifties. As readers of *Wireless World* will remember ("Loudspeaker without diaphragm," January, 1952) the ionophone is a loudspeaker in which the conventional diaphragm is replaced by a column of ionised air located at the throat of an exponential horn. The excitation is provided by an amplitude modulated r.f. arc. The power for this was provided by two EL38s operating in class C at 20MHz, coupled to a self-resonant inductance. Power input was about 40 watts.

Having tried unsuccessfully to eliminate a large wart near my knuckle with silver nitrate, trichloroacetic acid and finally a soldering iron, I conceived the notion of employing r.f. energy from the ionophone oscillator. About five seconds treatment with a stub tapping, a few turns up the self-resonant secondary, generated enough heat in the wart to kill it, and healing was complete in two weeks.

J. A. Carder
Wrecclesham
Surrey

Editor's note: Mr Carder's experience is interesting, but we would not like to encourage readers in self-treatment of this kind.

SYNTHESIZED F.M. TRANSCEIVER

IT was good to see an article aimed at the amateur fraternity but using current technology, viz. the c.m.o.s. variable divider chain in the synthesizer (November and December, 1977 issues). While not wishing to criticise in any way Mr Forrester's article, which obviously relates to a transceiver now giving him excellent service, I feel the following comments may be helpful to other potential constructors:

1. The 4059 divider, used here to 6.08MHz, is guaranteed by the manufacturer to operate to 3.0MHz (at 10V), 6MHz being only a typical figure. Since the 4059 costs about £6, selection of a suitable sample could be risky or expensive.

2. The set of 4059 plus 3-off 4560 c.m.o.s. i.c.s forming the variable divider chain cost

about £12. A v.h.f. prescaler is relatively inexpensive — the Plessey SP8655 is guaranteed to 200MHz (+ 32), interfaces directly with t.t.l. or c.m.o.s., draws 50mW (typical) and costs about £8. By using such a device the v.c.o. could be operated at final frequency, avoiding spurious signals from the usual multiplication process, thus saving two multipliers in the transmitter chain, two multipliers in the receiver chain, and the existing +4 prescaler. Moreover, the reference frequency would be 25/32kHz and the maximum input to the 4059 reduced to 4.56MHz (still outside the guaranteed figure, but more acceptable than 6.08MHz).

3. When changing frequency in a synthesizer there is always a period prior to locking when the v.c.o. is sweeping towards the new frequency. Although this may exist only for about 100ms in a system such as this with a reference frequency around 1kHz, it will occur every time the transmitter is energised. The transmitter would be capable of delivering full power while its output is swept from receiver l.o. frequency to transmitter frequency, i.e. over 10.7MHz. The block diagram given does not indicate the presence of a suitable "inhibit until locked" circuit for the transmitter, and so operation could certainly cause interference to other users, apart from the operator unwittingly contravening the terms of the amateur licence.

4. It is essential to provide an adjustment for pulling the reference crystal to precisely the correct frequency, since the typical manufacturing tolerance of $\pm 0.005\%$ on crystal frequency represents $\pm 7.25\text{kHz}$ at 145 MHz.

J. A. Short
Farnborough
Hants

EXPERIMENTS ON PHASE AUDIBILITY

SEVERAL readers have asked for further clarification of two points in my article on phase audibility (October 1977 issue, pp. 79-81). I would therefore like to add a few comments to the record, as follows.

Question: Were the Bose 901 loudspeaker tests done "up close", and were they "blind"? Answer: The single Bose speaker, and also the crossed-over pair of Bose speakers, were compared with the live performance "up close", that is, at a distance of ten feet from the listening jury. The tests were run blind, through a lit-up gauze curtain. Listeners could not be fooled at this distance, but a rank ordering of quality (best, equal, worst) was attempted. The essentially phase-coherent playback was not any more like the live performance than was the phase-distorted playback.

When the tests were run indoors, in a typical household environment, the Bose speakers were able to fool listeners at a distance of 35 feet (through a large, open doorway), but not any closer. The Magnepan speakers fooled the listeners at 25 feet indoors and 15 feet outdoors, but not at ten feet.

Daniel Shanefield
Princeton, N.J.
USA

Editor's note: The following corrections should be made to Dr Shanefield's article. On page 79, middle column, the final six lines of the column should have been printed before

the penultimate line of the first column (after the word "But..."). On page 80, first column, line 27 should read "... don't have perfect enough transducers to do the ...". On page 81, first column, line 5 should read "... did produce essentially coherent ...". Also on page 81 "Magnapan" should be spelt "Magnapan", reference 13 should be deleted, and there should be a note stating that the article was based on a paper presented to the Boston Audio Society (USA) in July 1976. Apologies for these errors.

LONG DISTANCE U.H.F. RECEPTION

I AM one of a number of enthusiasts, both professional and unconnected with radio communication, who are experimenting with consistent long distance u.h.f. reception particularly of television signals and using very high gain receiving systems. We have experimented with arrays of high gain Yagi aerials and have now begun to investigate the characteristics of parabolic reflectors. Unfortunately we are finding it almost impossible to find practical down-to-earth articles on the subject in print and wonder if any of your many thousands of readers around the globe would like to exchange details of experiments, among which are optimum size of dish, optimum focus to diameter ratio, height above ground level, optimum low noise amplifier configuration, etc.

So far with a temporary 25ft diameter dish a few feet above ground we have confirmed the precise focusing effect and very high gain of a parabola but it has been a matter of many hours of tedious experiment. Also tried was diversity at separated sites of reception over a 180 mile path, with the result that the further the separation of aerials the better, at least up to 3 miles so far. Along the coast where we have been experimenting the signal levels of the distant 500kW television transmitter in Cornwall vary tremendously depending on the tropospheric propagation, ranging from a couple of microvolts to tens of millivolts over even short periods of reception, i.e. 24 hours. We would like to hear of similar attempts at long distance reception of u.h.f. signals on the basis of exchange of ideas and results. Someone somewhere must be spending countless hours experimenting on a similar basis.

Des Walsh EI5CD
Ballylynch
Carrick on Suir
Co. Tipperary
Rep. of Ireland

USEFUL CALCULATOR TRICKS

BEING an owner of the CBM 4190 electronic calculator, I have discovered a couple of useful tricks which this excellent machine will do and which are not mentioned in the rather brief CBM handbook.

1. The "integration" function can be used not only to find the area under a curve, but also the area inside a loop, i.e. a cyclic integral can be evaluated.

This is done simply by entering in the x and y co-ordinates of a number of points round the loop, in the same way as in the area-under-

the-curve method. However, the first point entered must be entered again at the end of the sequence, to complete the loop. The first point can be anywhere on the loop, and the points can be entered either clockwise or anti-clockwise.

This facility will be found extremely useful for calculating the "work done" in pressure-volume diagrams, and for finding the hysteresis loss from B-H and similar curves.

2. A conversion from decimal to degrees-minutes-seconds format is normally performed by entering the decimal number and using F.8. However, even when many numbers need to be converted, the F.8 only needs to be used once, at the beginning of the sequence. This is done as follows: Enter the first number and press F.8. This converts the first number. Now simply enter the other numbers, pressing only the = key after each one.

The only apparent problems with this method are that numbers like .25 must be entered as 0.25, and negative numbers are not permissible at all.

It is worth mentioning that converting 34-24-36 (degrees-minutes-seconds format) into degrees Centigrade gives an interesting answer of the order of 10^{10} . This is of course completely useless for most applications.

Peter Holy
Worthing
Sussex

AUDIBLE AMPLIFIER DISTORTION

PETER BAXANDALL and Peter Walker clearly set much store by transfer distortion assessments of an amplifier's audible performance. ("Audible amplifier distortion is not a mystery", November 1977 issue). But, despite the subjective experiments Mr Baxandall has devised to ascertain, to his satisfaction, that interaction of sub-threshold distortion with signal does not take place as a result of the complex (and poorly-understood) process of the auditory response, the validity of this technique (in terms of listening to the difference signal as opposed to measuring it) rests firmly on the assumption that such interaction does not occur.

The study of binaural beats has clearly shown, however, that this can indeed take place. The threshold of hearing is a psychological rather than physical phenomenon; binaural beat research has indicated that our brains can detect and process sounds down to at least 20dB below threshold. Consequently we have to be careful to define precisely what we mean by "hearing" a sound. It's altogether safer, perhaps, to talk in terms of perceiving sounds when we are conscious of them (which is the meaning in which we normally use "hearing") and monitoring sounds (for want of a better term) when we detect and process them at levels below threshold.

Of course, the fact that we do "monitor" sound and that under certain circumstances it can interact with super-threshold sounds such that their perception is altered does not necessarily mean that sub-threshold distortion in audio amplifiers produces audible degradation of music signals. What it does do, however, is throw a somewhat jaundiced light on Mr Baxandall's conclusion that the "true significance" of amplifiers producing

total silence in transfer distortion tests is, "quite inescapably, that such amplifiers are subjectively perfect." You may well believe this to be so, Mr Baxandall, and time may prove you correct but, as yet, the response to your flat assertions can only be — "non sequitur."

K. D. Howard
Oxford

Reference

J. Oster, G. "Auditory Beats in the Brain," *Scientific American*, 229, No. 4 (October 1973), pp 94-102. Offprint No. 1282.

AUDIO is a prolific breeder of folklore, so a reminder of the need for rationalism is always timely; we stand on the slippery slope of superstition once we abandon our belief that audio phenomena are matters of physics, not magic. Mr Peter Baxandall (November 1977, p.63) provides just such a necessary reminder, but unfortunately throws out the baby with the bath water.

The wires going to an electric bell are part of an oscillation-determining circuit involving milli-microsecond transients (they cause radio interference) and it is by no means obviously absurd to suppose that the high-frequency impedance of the wires could affect the action of the bell to an extent that can be heard. On the contrary, it needs calculation based on the mechanisms supposed to be acting before it can be concluded whether or not a significant effect is likely; and even then the conclusion is vulnerable to whether all relevant mechanisms have been correctly identified.

Moreover in audio we are largely deprived of quantitative limits until we have a comprehensive theory of how the ear and brain act. If such a theory exists I have yet to hear of it, and the history of audio might be described as a century of underestimating the sensitivity of perception by the human ear.

It is of course tautologically correct that if linearity and frequency response are the sole significant properties, then all amplifiers will sound alike if they have identical frequency response and are tested under conditions which include "avoidance of overloading". The difficulty is to define, without logical circularity, when all forms of "overload" (i.e. non-linearity) have been avoided, as they were not in early class-B transistor amplifiers, or more recent slew-rate limited ones, that passed all the distortion tests that were initially thought sufficient. In each case our ears told us what we only afterwards learnt how to measure.

Leinonen and Otala¹ have reported measurements on a power amplifier which passed with flying colours total harmonic distortion, SMPTE and CCIF intermodulation and dynamic intermodulation tests but showed unexpectedly large frequency-transference of energy in the noise-intermodulation test. This finding may be connected with the opinion of some listeners, accused in consequence of claiming to have "golden ears", that the subjective performance of this amplifier leaves something to be desired.

Peter Fellgett
Department of Cybernetics
University of Reading

Reference

I. Leinonen, E. and Otala, M., "Correlations of Audio Distortion", AES 56th Convention, preprint 1223 (G-1), March 1-4, 1977; Fig. 9.

MOST OF THE radio aids so far described are situated within the airways where they can be of utmost use to aircraft flying within the system. It is not, however, generally realised that business and private aircraft movements outweigh those of the scheduled airlines, and pilots of these smaller aircraft often cover routes not served by conveniently situated v.o.r./d.m.e. facilities or even suitable n.d.bs for use with the radio compass.

Area navigation, as opposed to hopping from beacon to beacon within the airways, entails planning the route using pre-selected turning points, or waypoints, for the purpose, most of them not served by a radio aid. Since the weather may preclude recognition of these waypoints by map reading, other means have to be provided. One such method is known as RNav. It makes use of v.o.r. and d.m.e. information which is fed to a computer provided with the means of off-setting a convenient v.o.r./d.m.e. station from its existing position to where you want it to be. Thus a pilot may "move" the nearest v.o.r./d.m.e. station to, for example, a farmer's field. In its simplest form RNav makes use of the aircraft's existing v.o.r./d.m.e. equipment to which is added a computer with setting knobs for entering the bearing and distance of the shift from the existing to the "ghost" position of the ground facilities. More advanced versions have a readout, with keyboard entry and the ability to store a number of waypoints. At any time the pilot may ascertain distance to run and time to go for the next waypoint. This remarkable navigation aid is, of course, very convenient to use but in moving the v.o.r./d.m.e. facility to a place of the pilot's choosing it takes with it all the errors associated with v.o.r.

Decca Navigator. More accurate than RNav but heavier and far costlier is the Decca Navigator, a system invented by an American who, believe it or not, came to Britain and set up a company to develop it because there was no support for him in the USA. Like v.o.r. the Decca Navigator is a phase comparison aid but here the similarity ends. It operates in the 70-130kHz band and the ground arrangement consists of a master transmitter and three slave stations positioned some 50-100nm from it at roughly 120° intervals (Fig. 4). The complete installation is known as a

Fig 4. Decca chain showing the Master station, M, and the Red, Green and Purple (R, G, P) slave stations. In the interest of clarity only the hyperbolic phase pattern generated by the Purple/Master baseline is shown. Similar patterns are generated by Red/Master and Green/Master baselines.

by Alan Bramson
M.R.Ae.S

Radio on the flight deck-2

Concluding with area navigation systems and landing aids

Decca chain and a number of them cover certain areas of the world.

The method of operation is as follows. The carrier waves of the master and its three slaves are phase-locked and if one imagines wave relationships along the baseline between the master and one

slave it will be realised that a number of intersections will exist at half-wave intervals. A phase comparison meter equipped with some form of counter would be able to determine position along the baseline. Looking at the system in plan form the half waves can be imagined as concentric circles based upon each of the four transmitters. This is shown in Fig. 4. The three slave stations are named Red, Green and Purple and the intersection of Red/Master, Green/Master and Purple/Master half-waves creates three hyperbolic patterns in the sense that each hyperbola is the locus of all points with a constant phase difference.* The patterns are known respectively as Red, Green and Purple, and the complete hyperbolic lattice covers a considerable area.

In the aircraft is a receiver capable of accepting transmissions from the three slave stations and their master. Phase comparison units determine the position of the aircraft on the Red, Green and Purple lattice lines so that a fix can be obtained from the intersection of these lines, and the rest of the story is a matter of presentation.

In its earlier forms the information was conveyed on three Decca Meters and readings from them had to be related to special maps overprinted with the Red, Green and Purple hyperbolic patterns in those colours. Now the entire system is automatic, there is a

* For a full explanation see "Hyperbolic radio navigation systems" by F. S. Stringer, *Wireless World*, August 1969, pp. 353-357.

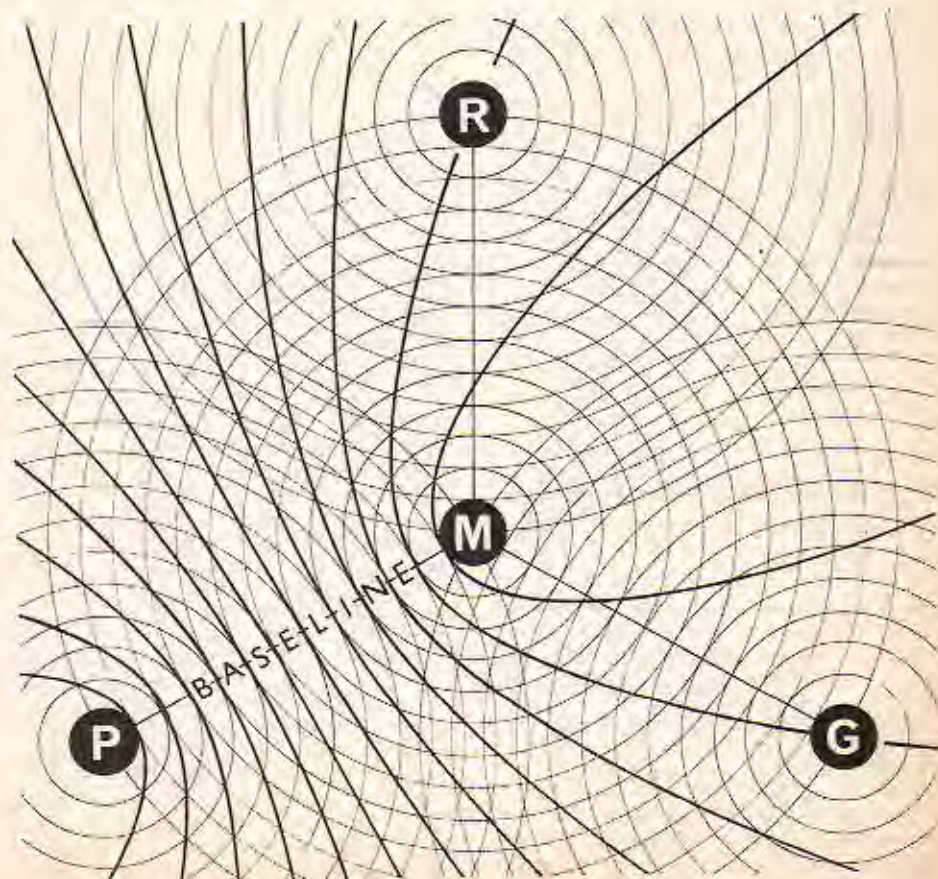

moving map display and the charts are made up in rolls like a large film cassette some 12in wide.

Decca is very accurate, some of the equipment being capable of providing a position to within a few hundred yards. However, it has been a long time attaining its present state of near perfection and events have tended to overtake the aid. Furthermore, there are not many Decca chains, so its coverage is limited.

Doppler. Unlike most of the other aids this equipment requires no ground stations. It measures forward and sideways speed by directing radio signals to the surface, receiving them at the aircraft and computing the resultant frequency shift, which is proportional to speed. The measurements are fed into a computer and displayed as miles flown and drift to port or starboard. The equipment, which for some time found favour with the airlines, is accurate in distance but rather less so when measuring sideways displacement resulting from wind effect. Also it can be troublesome when operating over smooth water. Now inertial navigators are being carried by the larger jet aircraft (two of them at £60,000 each) but these are not radio aids, being based upon accurate measurement of acceleration and deceleration on a gyro-stabilised platform.

Omega. The latest fashion in long range radio navigation is Omega, a v.l.f. hyperbolic aid* comparable with Decca which operates simultaneously on 10.2, 11.33 and 13.6kHz. Eight phase locked stations are situated all over the world and they provide time-synchronised transmissions corrected for ionosphere diurnal changes. Not all stations are available at once but at least three of them may be received in any part of the world. Apart from inserting the time and date into the equipment there is little else a pilot need do. A multi-position switch allows him to obtain more or less instant readouts for such parameters as distance from a particular point, bearing to or from that point, time to run for next waypoint, ground speed, wind velocity, position expressed as a latitude and longitude and so forth. Unlike most other aids Omega does not suffer from cumulative errors with time. It was originally developed jointly by Britain and the USA for long range submarine navigation but since it weighs considerably less than inertial navigation equipment and costs about one fifth of its price, Omega would appear to have a bright future. Marconi have recently won a contract from Pan Am for 105 sets.

Landing aids

At the end of the flight, assuming it is instrument flying weather, comes the moment of truth: the landing, perhaps at a time when cloud base is but a few

hundred feet from the ground and visibility might be reduced to 600 metres, a distance covered in about seven seconds at passenger jet approach speeds. Even when aircraft approached at 60-70 knots an instrument landing demanded some radio equipment and the earliest bad weather landings were conducted by flying overhead the airfield using the direction finding service when a lad in the control tower (and I am quite serious about this) stuck his head out of the window and shouted "engines overhead" at the appropriate moment. This being confirmed to the pilot he would fly a timed downwind leg before turning back towards the airfield and setting up a gentle rate of descent. On the way in frequent bearings were obtained by a frantically keying radio operator but fortunately these were the days of 60 knot approaches and there was time to think. V.d.f. (the v.h.f. homer already described) has allowed the bearing procedure to be speeded up, although it is only regarded as a cloud break as opposed to a precision landing aid. Very accurate are radar approaches as pioneered by the wartime GCA and developed to today's precision radar.

The charm of radar approaches is that nothing more than a v.h.f. transceiver is required in the aircraft. The disadvantage is that radar procedures are relatively slow at the very time when the aim is to avoid stacking over the non-directional beacons and get the aircraft on the runway with a minimum of delay. The key to speed is a matter of moving away from ground monitored procedures and giving the man at the controls pilot-interpreted aids. One of the earliest was standard beam approach, an audio aid where the pilot strained to hear dots and dashes or, when on the beam, a steady note. It was demanding and could be something of a trial at the end of a long and tiring flight.

The present day landing aid in widespread use is instrument landing system (i.l.s.). The ground installation consists of a "localizer" transmitter operating in the 108-112MHz band with aerials situated upwind of the runway being served. The aerials produce two radiation patterns, on the right modulated at 150Hz and on the left at 90Hz. These patterns overlap to form a beam 5° wide centred on the runway. In the aircraft the "nav" receiver (used for v.o.r. reception) feeds the signals to an instrument which is often combined with the v.o.r. indicator except that, in the i.l.s. mode, it senses the tone modulation as opposed to phase differences. Using the vertical needle shown in Fig. 2, this part of the equipment will with great precision guide the pilot along the runway extended centre line, full deflection of the needle left or right representing only 2½°.

Situated within a few hundred metres of the runway threshold is the glide path

transmitter operating in the 329.3 to 335 MHz band, its frequencies being paired with those of the localizer so that selection of the i.l.s. for a particular runway automatically sets up the glidepath receiver in the aircraft. The glidepath aerial system radiates two patterns, the upper lobe modulated at 90Hz and the lower one at 150Hz. They overlap to form a beam little more than 1° in depth which is directed down the approach path to the runway like a guiding searchlight inclined at an angle with the horizontal of 2½° to 3½° according to local terrain. Signals from the glidepath transmitter are received in the aircraft and displayed by a horizontal needle which crosses the left/right deviation needle of the v.o.r. indicator when i.l.s. is fitted. If he is above the glidepath the needle will give a "fly down" command to the pilot and so forth. So that he might be aware of his progress towards the runway the ground installation includes two marker beacons transmitting narrow vertical beams on 75MHz. They operate a blue "outer marker" light on the instrument panel at about 4nm from the runway threshold followed by an amber "middle marker" light, the middle marker being at a distance of 3500ft (distances vary slightly from airport to airport). Localizer indications are similar to v.o.r., i.e. "fly left", "on heading" and "fly right" commands are given by the deviation needle or, to use its name when operating in the i.l.s. mode, localizer needle. Glidepath arrangements, marker beacons and some of the indications provided are shown in Fig. 5.

The aid is very accurate and relatively simple to use, particularly when the information is presented to the pilot on one of the pictorial displays that these days form part of a modern flight system.

Flight director systems

The flight director is so closely related to radio that brief mention should be made here. Modern flight decks were becoming so cluttered with instruments it was not easy to find room for new radio equipment as it became available. But that was not the only problem. Pity the poor pilot — how much could he watch at any one time. So was evolved the integrated flight system presenting radio navigational information pictorially in conjunction with the gyro instruments that are essential for basic instrument flight, i.e., the control of aircraft attitude, balance and heading. But the scope of the equipment does not end here. The information may be linked via a computer to the autopilot which will then fly the aircraft from radio beacon to beacon and down the i.l.s. guidance system. Current flight systems are cleared to a decision height of only 100ft above the runway while autoland, which incorporates a radio altimeter and

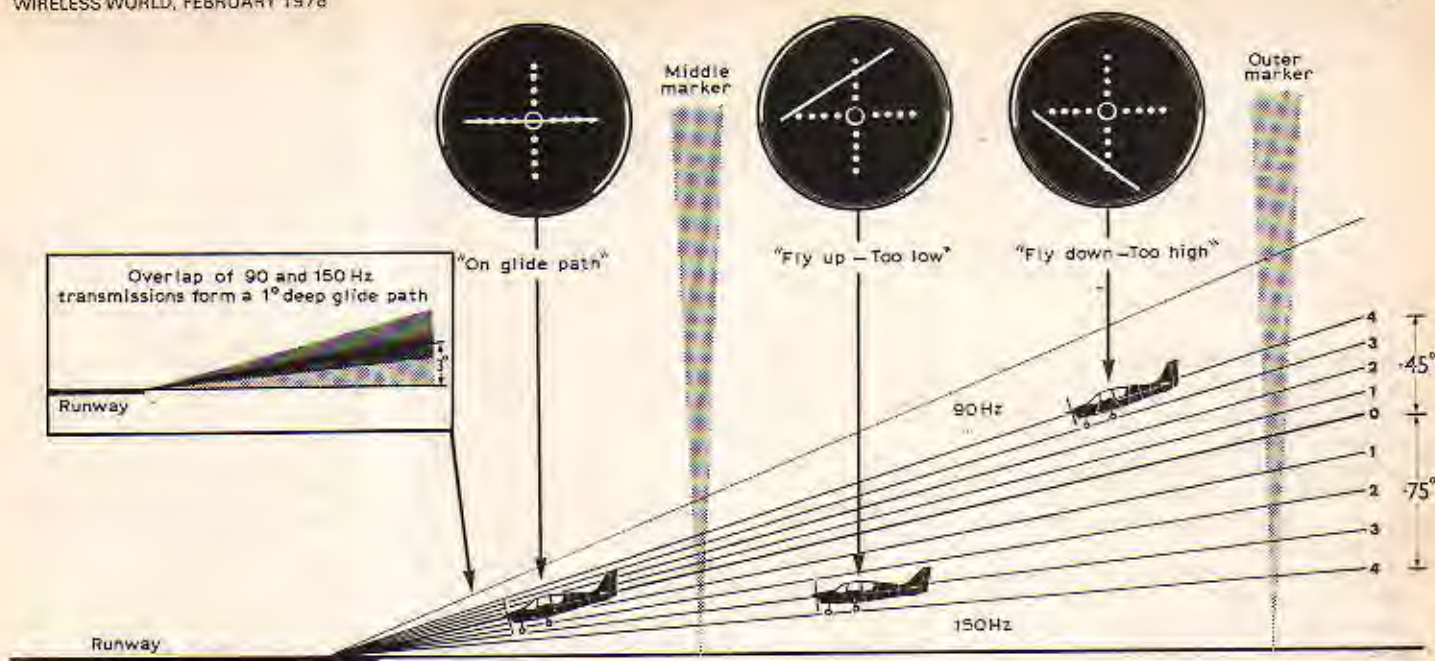

Fig 5. Instrument landing system transmission. Insert shows how the 90Hz (upper lobe) and 150Hz emissions overlap to form a 1.2° beam angled 2½° to 3½° from the horizontal. In the interest of clarity the vertical localizer needle which provides runway centre-line information has been omitted. It is read in conjunction with the horizontal dot scale on the instrument face (Fig 2, January).

autopilot throttle control, is a present day reality capable of landing an aircraft in visibility that makes taxiing back to the passenger terminal a problem — but that is another story.

Price of equipment

What does it all cost? Starting with light aircraft, a 720-channel communications set and a nav receiver with v.o.r. would vary in price from £700 to £1,800, while one can pay between £750 and £2,400 for a modern a.d.f. installation. D.m.e. is expensive at £1,900 to £3,000, and a transponder (without encoding altimeter) could add between £400 and £1,800. From personal experience I can tell you that the most reliable avionics are not always the dearest but, bearing in mind a well equipped touring aircraft, light single or twin-engined, would require the navigation and communications sets to be duplicated, one would think in terms of spending some £6,500 minimum. RNAV would add another £1,200 to £6,000 according to scope and a good autopilot will set you back £4,000. All this represents a high proportion of the total cost of the aircraft. Higher up the scale large transport jets might carry £200,000 of radio equipment or even more.

Whereas most of the radio designed for smaller aircraft is direct mounted with the cabinets and their controls

situated in the instrument panel, large aircraft banish the main installation to radio racks away from the flight deck and control it by indirect switching usually positioned on the central pedestal which carries the power levers and some of the other controls.

The future

It would be a very unwise man who claimed an intimate knowledge of what the future holds for aircraft radio. But certain facts are emerging. For example, there is a continued move away from things mechanical to electronics — v.o.r. displays that dispense with moving needles and display a bearing, say, as a digital readout. I.I.s. is likely to be replaced by a microwave landing system (see November 1977 News) which will allow the pilot a number of approach paths to the runway, not just one. And instruments as we know them, not just those relating to the radio but engine and flight instruments as well, may soon be replaced by cathode-ray displays. A joint Hawker Siddeley-BAC project has produced a very comprehensive VC10 flight deck using seven c.r.t.s in place of all but a few standby instruments. If a c.r.t. fails in flight the display may be switched to one of the others while the tube is removed and replaced like an electric light bulb. The cathode-ray flight deck is lighter in weight and likely to be cheaper than present day instrumentation.

The moving map display and "head up" instrument projections, which appear on the windscreen, are at an advanced stage of development and navigation by satellite opens up exciting new possibilities. But having regard to the astonishing pace of aircraft radio development this past twenty years who is to say what the future holds. □

LITERATURE RECEIVED

Publications catalogue of the Instructional Centre for Theoretical Physics (ICTP) now available from Division of Publications, IAEA, Karnthner Ring 11, PO Box 590, A-1011 Vienna, Austria WW 401

Load cells, pressure transducers and instruments in short brochure from Transducers (CEL) Ltd, Trafford Road, Reading, Berks RG1 8JH WW 402

Connectors, cables, p.c.b.s, wire-wrapping and instruments described in o.e.m. catalogue from Carel Components Ltd, PO Box 654, 40/44 The Broadway, Wimbledon, London SW19 1SQ WW 403

Vibration testing equipment in generally descriptive leaflet (not catalogue) from Derritron Electronics Ltd, Sedlescombe Road North, Hastings, East Sussex TN34 3XB WW 404

Microwave alternators, including rotary stepped and programmable types, in catalogue from Telonic Berkely UK Ltd, 2 Castle Hill Terrace, Maidenhead, Berks S16 4JR WW 405

Opto-isolator applications outlined in 20 page handbook from 23 Churchgate, Hitchin, Herts SG5 1DN WW 406

Telephone call logging (time, number called and duration) is explained in an article in TR Technical, Winter 77 edition, from Telephone Rentals Ltd, TR House, Bletchley, Milton Keynes, MK3 5JL WW 407

Reliability of small-signal, metal-can transistors is the subject of a report from Motorola Ltd, Semiconductor Products Division, York House, Empire Way, Wembley, Middlesex HA9 0PR WW 408

Solid-state relays from I.R. are detailed in data sheet E2730A from International Rectifier Co (GB) Ltd, Hurst Green, Oxted, Surrey WW 409

CIRCUIT IDEAS

Precision timer

THIS circuit gives an audible tone lasting half a second at pre-selected times of 2, 4, 8, 16, 32 and 64 seconds. Two gates of the first i.c. are used as a square wave generator. A variable resistor of 500k Ω enables the generator to be set precisely against a known frequency. Where gates are being used as inverters the inputs are connected together. The

square wave, via a spare inverter, clocks the binary counter which is advanced one count on the negative going transition of each input pulse. The six outputs of the counter go to the selector switch, the output of which is used to trigger a flip-flop on the positive going edge.

The flip-flop is used to reset the counter to zero and is set itself by the next positive going clocking pulse.

Counting from zero then resumes at the next negative going clocking pulse. Two gates of the second i.c. are used as an audio frequency oscillator which drives a crystal earpiece through a spare inverter. The oscillator is normally off and is switched on for the half second that the counter is being reset.

J. M. Osborne,
London S.E.15.

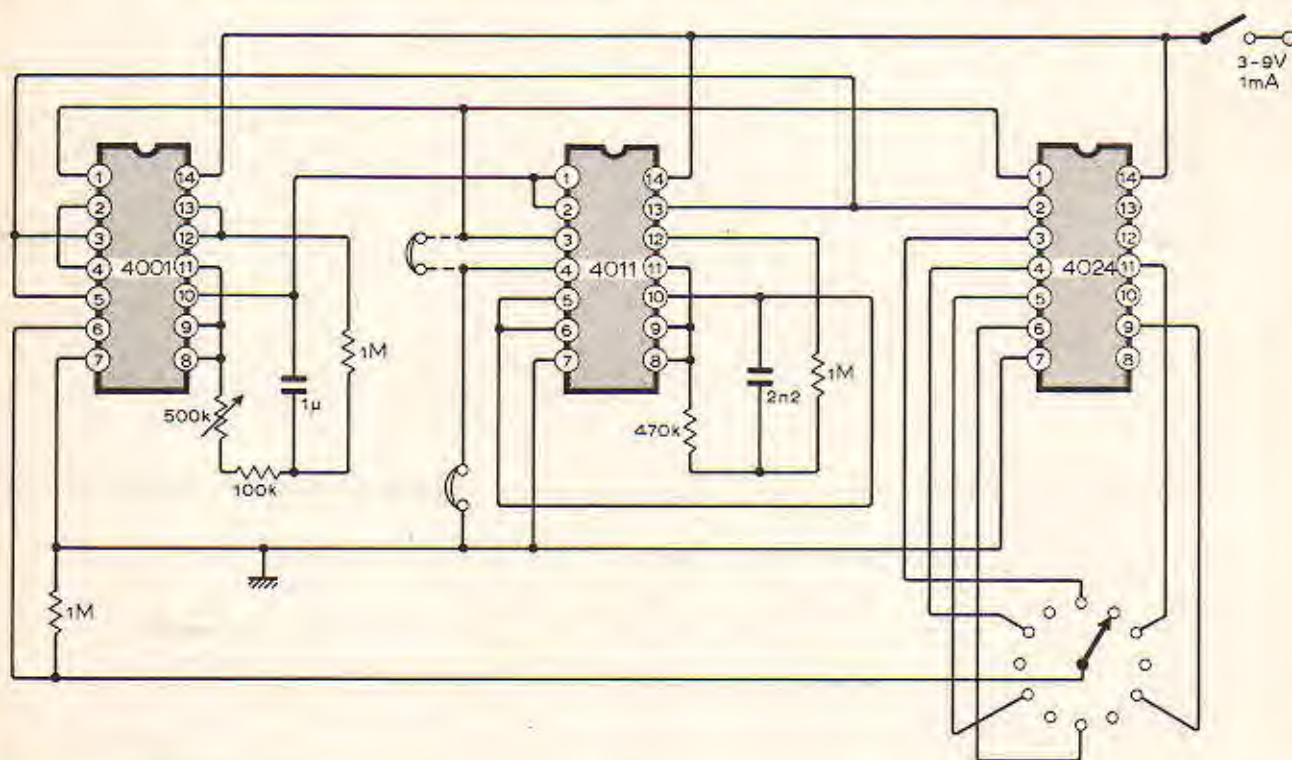

Non linear a-to-d conversion

THE Ferranti ZN425E has become a popular device for low cost analogue to digital conversion. A simple modification to the usual circuit enables the i.c. to perform non-linearly as though preceded by a compression amplifier.

If the internal fixed reference voltage is not used and an external source is connected to the V_{REF} input whose voltage rises linearly from zero at the start of each conversion, the digital output will be proportional to the square root of the analogue input voltages as shown in (a). If the reference voltage reaches a plateau during the conversion period, a

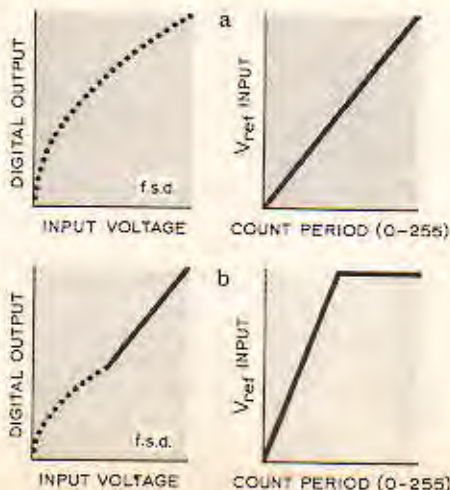

linear response will be obtained from that point (b). Either an analogue ramp generator or a second ZN425E can be used with its clock and reset inputs in parallel with those of the main i.c.

J. P. FitzGerald,
London W.5.

Variable-speed radio control motor

PROPORTIONAL radio control systems produce control pulses every 20ms whose length can be varied from 1-to-2ms. This circuit removes the first 1ms and expands the remaining 0-to-1ms to produce 0-to-20ms pulses which drive the motor. The motor may therefore be driven all of the time, none of the time, or any amount between. Pulsing the motor in this way is more efficient than adjusting series resistors, and gives smoother control, especially at very low speeds.

The rising edge of an incoming pulse turns Tr_1 on via the $0.1\mu F$ capacitor. This holds Tr_2 off for the first 1ms. The remainder of the pulse turns on Tr_2 which acts as a current source and removes a controlled amount of charge from the $1\mu F$ capacitor. Transistors Tr_3 and Tr_4 turn off allowing Tr_5 to drive the motor until the $100k\Omega$ resistor has recharged the $1\mu F$ capacitor and Tr_3 re-saturates. This cuts off the motor drive after a time proportional to the width of the input pulse. The circuit is

then ready for the next input pulse. The output circuit includes fold back current/voltage protection as well as limited base drive to the output transistor. These may be adjusted to suit the motor and output transistor by altering the components marked with an asterisk. If full protection is not required the dotted component may be left out. The semiconductor types are not critical: in the prototype an OC28 was used for Tr_5 .
M. Weston,
Epsom,
Surrey.

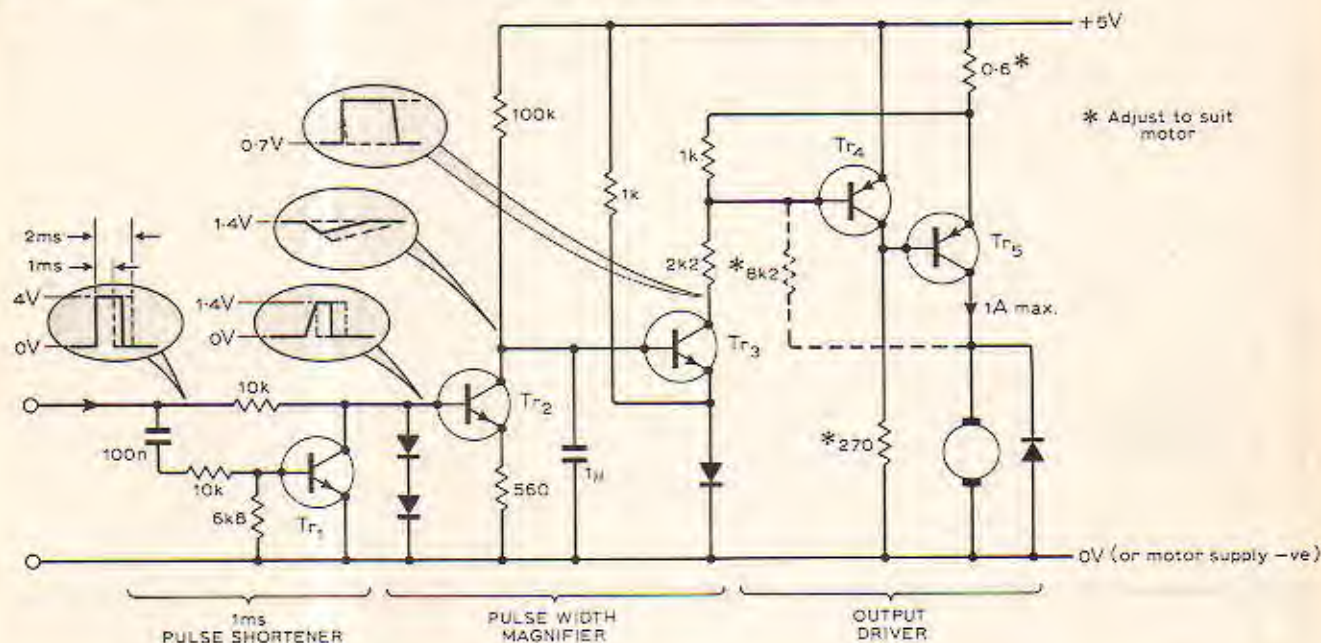

Simplified multiplexing

A SIMPLE method of multiplexing three or more displays is to gate a 7490 counter output via a 7401, and then wire OR the outputs. The 7401s are switched on in rotation by the positive enable signal which also switches the displays on in turn. If common cathode displays are used the segment and display enable signals must be inverted. The use of 7400s is cheaper than using HEX inverters. If the displays are individual units the segments must be paralleled together.

G. A. Bobker,
Bury,
Lancs.

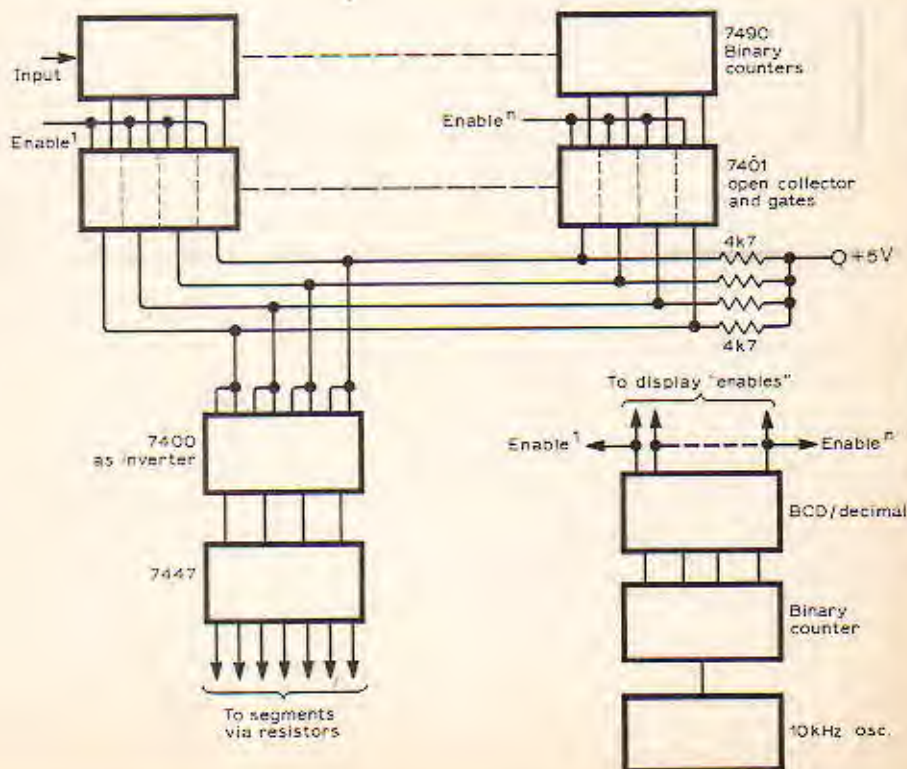

Universal matrix decoder

AN inconvenience when experimenting with matrix surround-sound is that a separate decoder is normally used for each system. However, the decoding is always done by a matrix of the following form,

$$\begin{bmatrix} L_F \\ R_F \\ L_B \\ R_B \end{bmatrix} = \begin{bmatrix} a_{11} & a_{12} \\ a_{21} & a_{22} \\ a_{31} & a_{32} \\ a_{41} & a_{42} \end{bmatrix} \begin{bmatrix} L \\ R \end{bmatrix}$$

where the coefficients a_{11} to a_{42} vary in amplitude from 0 to 1 and in phase from 0° to 360° . Rewriting them in the form $a_{rc} = b_{rc} + jc_{rc}$, the decoding equation becomes,

$$\begin{bmatrix} L_F \\ R_F \\ L_B \\ R_B \end{bmatrix} = \begin{bmatrix} b_{11} & c_{11} & b_{12} & c_{12} \\ b_{21} & c_{21} & b_{22} & c_{22} \\ b_{31} & c_{31} & b_{32} & c_{32} \\ b_{41} & c_{41} & b_{42} & c_{42} \end{bmatrix} \begin{bmatrix} L \\ jL \\ R \\ jR \end{bmatrix}$$

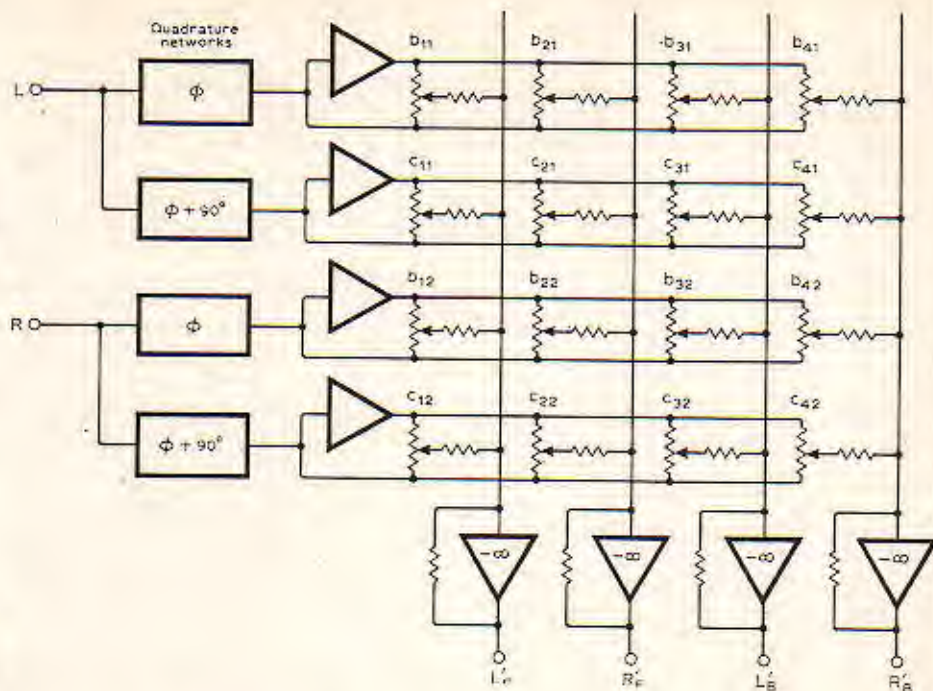

If the b and c coefficients are made variable between -1 and $+1$, any required decode matrix can be set up. The ϕ and $\phi + 90^\circ$ quadrature signals are derived by the well known all pass networks used in commercial decoders.

If required, several sets of coefficient potentiometers or fixed resistor dividers can be made on plug-in boards.

D. Hamill,
Hamill Electronics Ltd,
London SW20.

Triple-voltage power supply

LOGIC systems frequently require ancillary analogue circuitry which cannot be fed from a 5V power supply. This simple circuit is suitable for obtaining $\pm 12V$ and $+5V$ regulated supplies from a single transformer.

A standard Douglas MT3AT transformer has been modified by isolating half of the secondary winding. This is achieved by unsoldering the ends of the windings at the 15V tapping and connecting them to separate tags.

Three d.c. outputs are provided which are suitable for use with series stabilisers. The current ratings have been selected with a practical circuit in mind, but within the limitations of the transformer they may be apportioned to suit individual applications.

Because the connection of the $+18V$ rectifier is unconventional it is worth noting that purists may wish to isolate the windings at the 24V tapping, and to use bridge rectifiers throughout.

J. A. Hardcastle,
Huyton,
Liverpool.

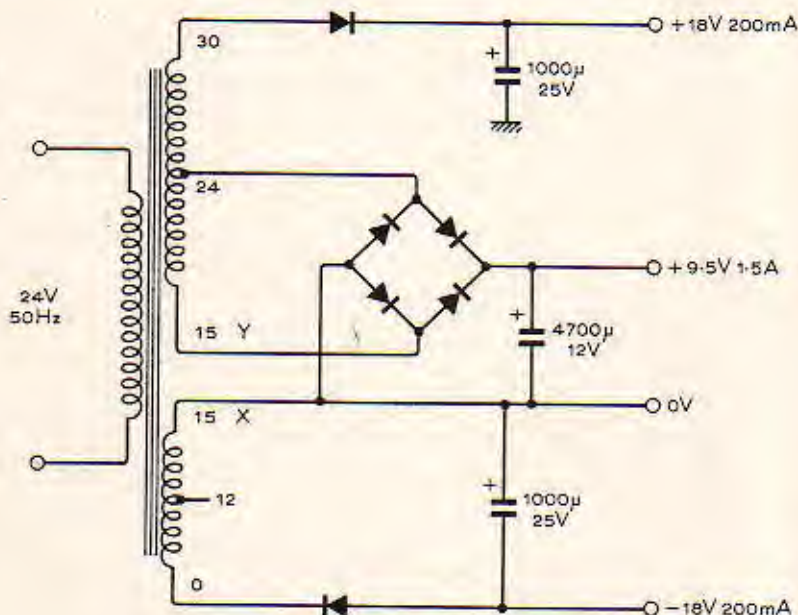

TEST OUR STRENGTH Accuracy and Simplicity

All packed into one remarkable, lightweight tester.

Engineered with a light touch to simplify your task on site, the new Plessey Telegdata Telegraph Circuit Tester - TCT10 makes light work of testing your circuits and machines.

Look at the unique advantages offered by this new very comprehensive tester, designed to the high standards of accuracy and reliability demanded by modern telegraph and telex administrations.

- Well laid out controls. Simple clear marking
- 50/330 bauds. Crystal or variable control
- Codes selection by switch, 5 or 8 unit and parity
- Output compatible with V28 Full range of double and single current telegraph signals
- "Fox" and Q9S test messages
- Switch selection of any 5 or 8 unit characters
- LED Display
- Speed synchronisation, bias, start/stop and peak distortion measurements
- Measurements in 1% or 2% steps
- Don't delay - send today for a complete specification of the Telegraph Circuit Tester, TCT10

 **PLESSEY
CONTROLS**

Plessey Controls Limited
Sopers Lane, Poole, Dorset
United Kingdom BH17 7ER
Tel: Poole (02013) 5161 Telex: 41272

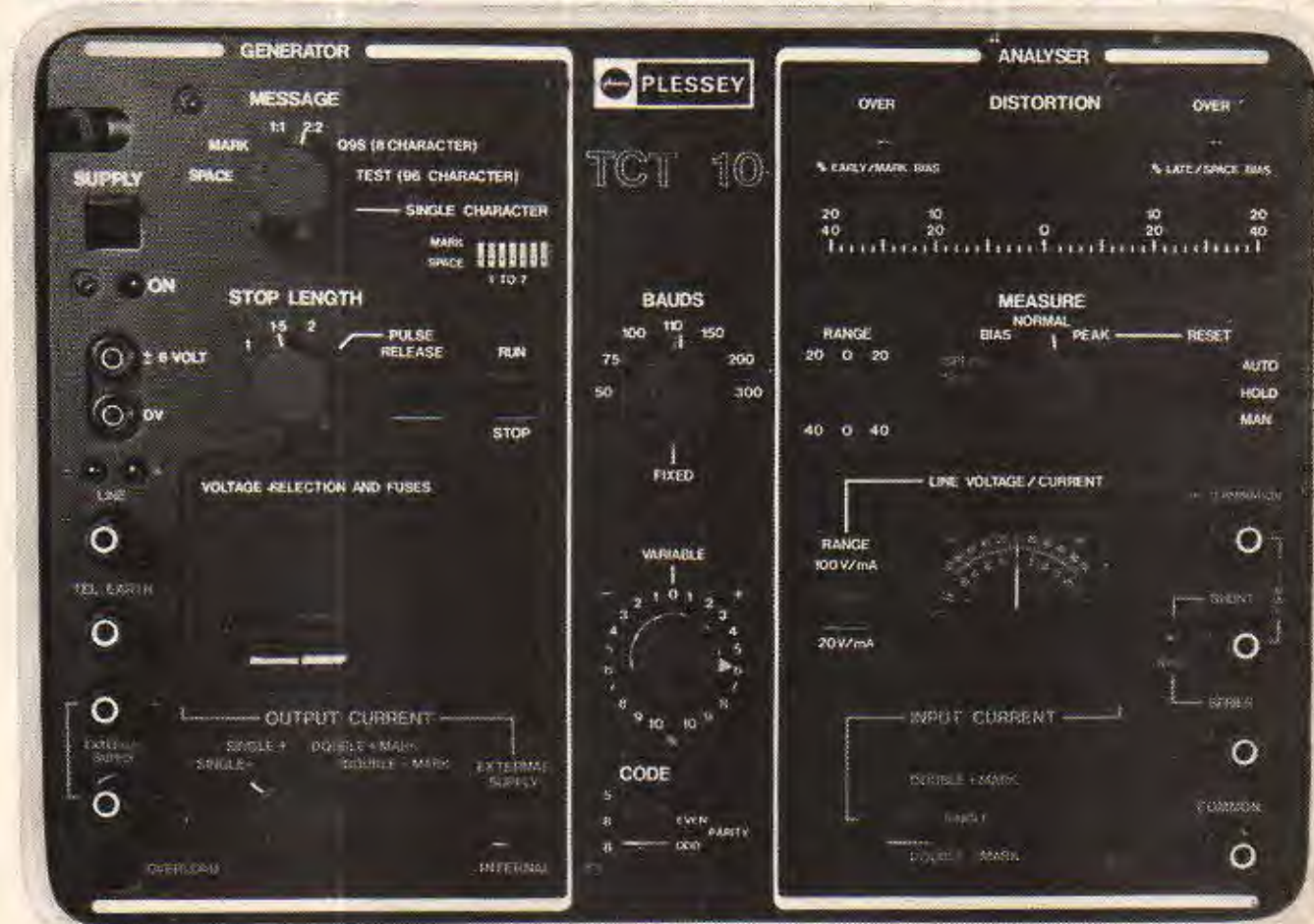

800P159 A

WW-037 FOR FURTHER DETAILS

'Valves are finished'



their best friends should tell them!

Valves from



**THE
HOUSE
OF POWER**

Pinnacle Electronic Components, Electron House, Cray Avenue, St. Mary Cray, Orpington, Kent BR5 3QJ. Phone: Orpington 71531 Telex: 896141
Northern/Midlands Sales Office: 11 Palmyra Square, Warrington. Phone: Warrington 50145. Telex: 627349

WW — 049 FOR FURTHER DETAILS

P.c.b. layout for high-speed Schottky t.t.l.

Requirements of printed-board design for low inductance and effective decoupling

by D. Walton, B.Sc. (Hons), Ph.D.

A great deal has been written on the subject of logic design and quite comprehensive books appear almost monthly. In general, however, the published material neglects an extremely important area and one which probably gives the most trouble to practising engineers. This area, which is dealt with in the present article, is concerned with the layout of logic on printed circuit boards in order to ensure reliable operation. The impetus for writing this article comes from the author's own experience of the lamentable lack of understanding of these basic considerations.

IT SHOULD not be concluded from the preamble that the subject is a difficult one; indeed the mathematics employed in the present paper is extremely elementary. The problems are caused rather by the historical progression from analogue to digital techniques with the consequent carrying out of well-tried analogue practices into the digital environment. Unfortunately, the requirements for digital circuitry are frequently opposite to those needed by the analogue variety and hence there is a need for a complete reconsideration of the requirements.

Low inductance bussing

To understand the criteria which determine how the supply and GND lines should be distributed to the t.t.l., first take the case of a t.t.l. gate driving its output line from low to high. For the gate to drive the output line high it must pass current into it. The output line must be considered as a transmission line of impedance Z_0 , if its length exceeds 10cm. In practice, Z_0 will be in the region of 100Ω and for a single logic signal changing from low to high the instantaneous output current will be given by $I_0 = 5/100 = 50\text{mA}$. This current must be obtained from the supply rails in a time comparable to the risetime of the signal. If, for Schottky t.t.l., $t_{r(\text{min})} \geq 1.5\text{ns}$, then charge must be transferred from the decoupling capacitor to the gate and hence to the output line in this time. Remember that charge is obstructed from flowing into the gate by the inductance, L , of the loop ABCD in Fig. 1. If this is approximately 2cm

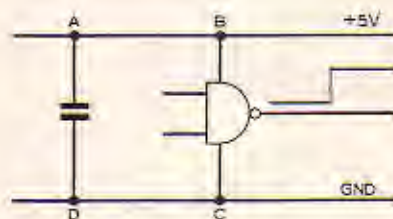

Fig 1. Example of gate, with decoupling, producing a low-to-high transition.

square with reasonable track width then, using the formula for parallel wires, $L = \ln(a/r) \mu_0/4\pi \approx 30\text{nH}$. The e.m.f. dropped across L will then be given by $E = -Ldi/dt$. Therefore,

$$E = \frac{30 \times 10^{-9} \times 50 \times 10^{-3}}{1.5 \times 10^{-9}} \\ = 1 \text{ volt}$$

This is a considerable voltage and it should be remembered that it is the result of a single gate switching. If all four gates in a pack switch together the currents will be additive and the rail will fall by 4 volts.

The first requirement of a power distribution system must therefore be low inductance between the i.c. and the decoupling capacitor. This is achieved by the track layout shown in Fig. 2(b), where a low inductance path from C to the i.c. is provided by keeping the V_{CC} and GND tracks close together.

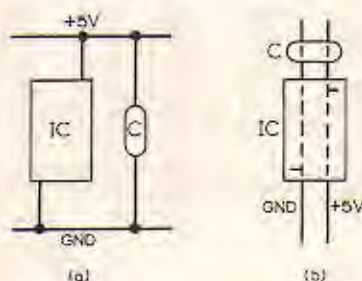

Fig 2. Two ways of laying out supply lines. Preferred method, giving lower inductance, is at (b).

Manufacturers of i.c.s usually specify one decoupling capacitor for every 5–10 i.c.s which, with the track layout of Fig 2(a) results in prohibitively high inductance between the capacitor and the

worst-case positioned i.c. The safest course is to provide the track layout as in Fig. 2(b) but also to put one capacitor adjacent to each i.c. Clearly, this can be achieved by having one capacitor for each pair of i.c.s.

Decoupling capacitors

The foregoing argument shows that the capacitor is better thought of as a reservoir capacitor which supplies the local, instantaneous current demands as i.c.s switch. This means that the important parameter for such a capacitor is the instantaneous current which it can supply. Some manufacturers specify capacitors for i.c. decoupling by giving the maximum pulse risetime, which corresponds to a maximum current for a given size of capacitor. For instance, a 47nF capacitor specified at $50\text{V}/\mu\text{s}$ can supply a current given by

$$i = C \frac{dv}{dt} = 47 \times 10^{-9} \times \frac{50}{10^{-6}} \\ = 2.5\text{A.}$$

which is adequate in the context of the previous calculation.

The other check to make is that the current drawn from the capacitor does not cause its voltage and hence the rail voltage to fall excessively. If the local demand is equal to 10 gates switching, the current demand will be 500mA; to be safe, assume that this demand lasts for 10ns, and design for a voltage drop at the capacitor of 50mV.

Thus,

$$i = C \frac{dv}{dt} \\ 0.5 = C \frac{50 \times 10^{-3}}{10 \times 10^{-9}} \\ C = 100\text{nF.}$$

This suggests that we should provide approximately 100nF for each pair of packages.

It might be thought that radio frequency type capacitors are necessary for t.t.l. decoupling, but this is not so. To show why requires more space than can be spared in an article of this type but essentially it is because the frequently adopted model of a capacitor, which

proposes that it possesses a lumped series inductance, breaks down in the case of a single applied step. There is therefore no reason for the designer to be afraid to employ non-ceramic capacitors provided they have adequate $V/\mu\text{s}$ ability. In the author's experience $1\mu\text{F}$ tantalum beads perform well as decoupling capacitors.

Transmission-line model

The best way to think of the power distribution system is as a transmission line, with each package connected to an ideal voltage source via an impedance equal to the transmission line impedance*. This impedance must be sufficiently low for negligible voltage transients to be produced on the line by gates switching within the package. The impedance of a transmission line is given by $Z_0 = \sqrt{L/C}$, where L and C are the inductance and capacitance per unit length respectively. To calculate Z_0 for the case of two tracks close together:

$$L = \frac{\mu_0}{4\pi} \ln \frac{a}{r}$$

where μ_0 is 5, A and r are taken as 2mm and 0.5 mm. Therefore

$$L = 0.6\mu\text{H}/\text{m}.$$

If a 100nF capacitor is placed every 5cm along this line, then:

$$C = 100 \times 20 \text{ nF m}^{-1} = 2\mu\text{F m}^{-1}$$

Therefore $Z \approx 0.5\Omega$.

An instantaneous current demand of 200mA – corresponding to 4 gates switching – will produce a voltage transient of 100mV. This is only just acceptable and suggests that the value of C should be increased. Note however, that laying out the tracks with wider spacing and using smaller capacitors – 10nF for every few i.e.s, which is not uncommon, will create a situation much worse than this.

Auto-decoupling in t.t.l.

In the context of the preceding remarks some readers may wonder how systems which they have seen or have worked with managed to function at all, since it is common to see most or all of the above design guidelines violated. To see the answer to this, consider the structure of the t.t.l. gate output circuit, when this is driving the following gate input low, as in Fig. 3.

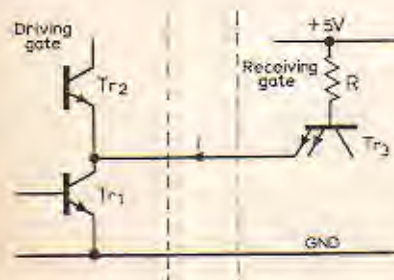

Fig. 3. Totem-pole t.t.l. output stage, driving succeeding gate low.

According to the specification for, say, a 7400 the typical values of i and R are 1.0mA and $4k\Omega$ respectively. When the gate output is low it sinks a current i_1 given by $i_1 = (V_{cc} - V_{be} - V_{CE(sat)}) / R$, where V_{be} is the base-emitter voltage of Tr_3 and $V_{CE(sat)}$ is the collector saturation voltage of Tr_1 .

If V_{be} and $V_{CE(sat)} = 0.7$ volts, to take a worst-case example, and $V_{cc} = 5$ volts

$$\text{then } i_1 = \frac{3.6}{R}$$

Now consider what happens if the rail voltage drops, due to a transient load imposed by the output of another gate switching. When V_{cc} drops there is no change (to a good approximation) in the V_{be} drops. Suppose the rail drops by 10% then:

$$i_1 = \frac{5 - 1.4}{R}$$

$$i_2 = \frac{4.5 - 1.4}{R}$$

Therefore

$$\frac{i_1 - i_2}{i_1} = \frac{0.5}{3.6} = 14\%.$$

In other words a 10% change in V_{cc} produces a 14% change in the current load placed on the rail. In effect what is happening is that each gate output which is holding another input low acts as a 'reservoir' of current and when the rail voltage drops as another gate drives its output high all the other gates give up some of their current to assist. This is what I would call the 'good neighbourliness effect' in t.t.l. In general, some gates on a voltage bus will be low and so act as current supplies. The problem arises when none or only a few are in this state – a critical situation for a badly designed system and one which could cause a failure. It should be remembered that a logic system should work for all possible combinations of states which can occur in practice and a hazard of this type could have serious consequences. It is therefore insufficient to demonstrate that a system 'works' because if the power distribution system is badly designed there is always the chance of an untested situation bringing about a failure of the system. It is assumed that in a logic system of reasonable size it is impossible to test all possible combinational situations, and doubly impossible to test all possible changes of situation!

The problem with Schottky t.t.l. is that the increase in speed does not allow time for the 'good neighbourliness effect' to act, consequently one is many

times worse off with Schottky than with ordinary t.t.l. Schottky is a less forgiving family than conventional t.t.l. and much more care must therefore be taken with power distribution to ensure reliable performance.

The current spike

As just described, the main cause of transient current demands in a Schottky t.t.l. system is the initial current surge when a gate switches into its transmission line load. The manufacturers' data overlooks the mechanism entirely. There is another cause of transient current demand which results from the 'push-pull' design of the t.t.l. output stage shown in Fig. 4. The cur-



Fig. 4. T.t.l. output configuration leads to current spike at transmission.

rent spike is produced because, on the 0 to 1 transition, the upper transistor turns on while the lower transistor is still turning off. This leads to a current surge of 10mA with duration of about 10ns¹. Provided the design guidelines laid down in the earlier sections with regard to power supply bussing and decoupling have been followed, this small additional hazard will be taken care of. In fact, since a logic gate is driving a transmission line which is a resistive rather than a capacitive load, there is no need to provide a totem pole output and this must be regarded as one of the bad features of the t.t.l. family.

Interconnexions

To implement a system successfully using the t.t.l. family it is necessary to interconnect correctly between logic gates.

Transmission lines. The correct model to use for interconnexion between logic gates is a two-wire transmission line. It is impossible to understand how a signal travels from gate to gate without taking the return path into consideration. Indeed it is impossible for a signal to travel without a return path! Consider the two-wire transmission line shown in Fig. 5, in which a zero rise-time is pro-

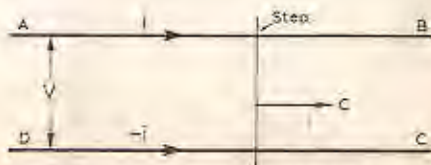

Fig. 5. Two-wire transmission line.

* A package at the centre of a power bus will see two lines in parallel and hence half the impedance. We will adopt the worse figure for the purpose of this argument.

pagating to the right with velocity c . Ahead of the step there is no current in the wires and no voltage differences between them. Behind the step there is a current i in the direction of AB and a current $-i$ in the direction of DC with a voltage difference V between the wires. It can be shown² that $V = iZ_0$, where $Z_0 = \sqrt{L/C} = \sqrt{\mu/\epsilon}$ where $Z_0 =$ characteristic impedance of line, $L =$ inductance per unit length of line, $C =$ capacitance per unit length of line, $\mu =$ permeability of medium between wires, $\epsilon =$ permittivity of medium between wires. The velocity of propagation $c = 1/\sqrt{LC} = 1/\sqrt{\mu\epsilon}$.

These equations are true for any two-conductor system where the resistance of the conductors can be neglected and the medium between the conductors is well-behaved. These conditions are met by tracks on a printed circuit board for any track width which can be manufactured. The step which we have just described is a transverse electromagnetic disturbance. Since the equation relating current and voltage on a transmission line is $V = iZ_0$, it follows that the effect of a transmission line on the driving circuit can be considered in terms of a resistance $R = Z_0$ connected in place of the line. This was the procedure followed earlier in calculating the current drawn from the supply rail by a gate as it switches.

The impedance Z_0 depends on the cross-sectional geometry of the conductors employed and its calculation is extremely difficult except for very simple cases. It is, however, a relatively slowly varying function of the geometry³ (usually logarithmic) and therefore this need not worry us too much. For a track on a printed circuit board laid out according to the design rules evolved in this paper a value of Z_0 of around 150Ω can be assumed.

One key feature of a board of logic which distinguishes it from most anal-

ogue systems is that there are a multiplicity of signal paths from various points scattered about the board to various other similar points. It is essential that each of these signal routes has an adjacent return path. The simplest way, conceptually, to achieve this is to provide a ground plane on one side of the board. In practice this is difficult since it usually requires multi-layer construction, with the increased cost and complexity which this entails, in order to accommodate the signal interconnections. With Schottky t.t.l. it is not necessary to go to this extreme; all that is required is a ground grid laid out so that a signal line is never more than one inch away from its return path.

Ground loops. It might be argued that this scheme leads to ground loops which, from our experience with analogue systems (e.g. audio equipment) are to be avoided. The plain fact is though, that on a logic board, ground loops are of no importance. The reasons for this are somewhat complex but it is probably useful to note one simple argument. In a high-gain amplifier, induction of a few millivolts at the input due to ground loop pickup can lead to an output of the same order as the signal. In logic this is not the case; a few millivolts into a gate input make no difference whatsoever. Hundreds of millivolts of noise are required before we will significantly degrade the noise immunity of a t.t.l. system.

It is probably valuable to examine a situation where a logic board has been laid out in order to avoid ground loops. A possible layout of power and ground connections, which is quite commonly adopted in the industry, is shown in Fig. 6. Now, if circuit A sends a step to circuit B there is no adjacent return path. In practice, since a fast step requires a return path it will simply use adjacent signal lines as returns, resulting in the induction of transient noise

on these other signal lines. A further consequence is that the input to B will take a longer time to settle with a consequent reduction in the speed of the system. As was explained earlier, the layout of Fig 6 is also bad from the point of view of placing excessive inductance in the way of charge travelling between i.c.s and decoupling capacitors.

Recommended layout

A recommended scheme for laying out a printed circuit board is shown in Fig. 7. The power rails are run as close together as possible along the columns of integrated circuit packages and are interconnected at the top and bottom of the board. These provide return paths for logic signals travelling parallel to them. To provide return paths for signals travelling across the board the ground pins of the packages are connected together from left to right. Thin track, of the same thickness used for signal interconnections can be used for this. A tantalum bead $10\mu\text{F}$ decoupling capacitor is provided between each pair of i.c.s. Notice also that ground connections are brought out at regular intervals across the edge connector. These provide return paths for signals travelling on and off the board.

If all these design rules are followed a reliable system will result and the consequent savings in servicing and testing will amply repay a little consideration given to board layout at the design stage.

References

1. Bonham, B. 'Schottky t.t.l.', T.I. application report B93.
2. Catt, I. 'Crosstalk (noise) in digital systems', I.E.E.E. Transactions on Electric Components, EC-16, 743-763 (1967).
3. Gunston, M. A. R. 'Microwave transmission line impedance data', Van Nostrand Reinhold.

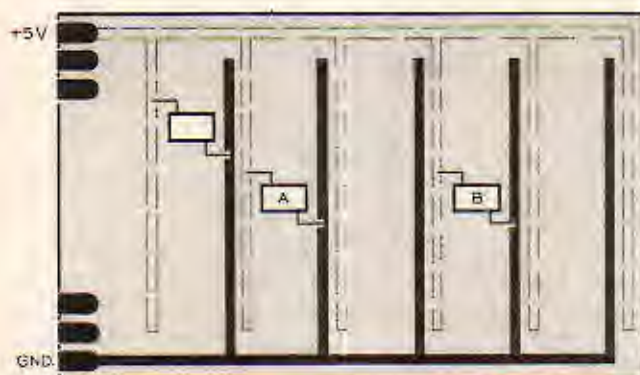

Fig. 6. A bad layout giving high inductance and few adjacent signal return paths, which leads to cross-talk.

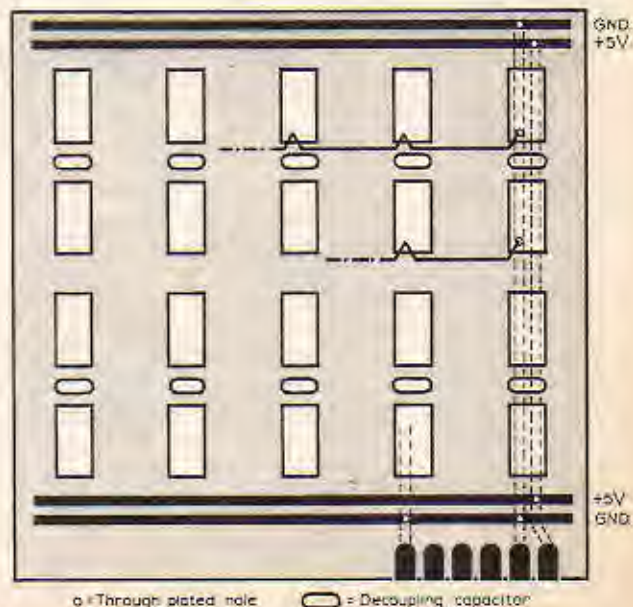

Fig. 7. Recommended layout.

○ = Through plated hole ◯ = Decoupling capacitor

Microcomputer design — 4

Practical realisation of a microcomputer system

by C. D. Shelton, B.Sc.(Eng.), A.CGI, M.Phil, Ph.D.,
in association with Shelton Instruments Ltd and NASCO Ltd

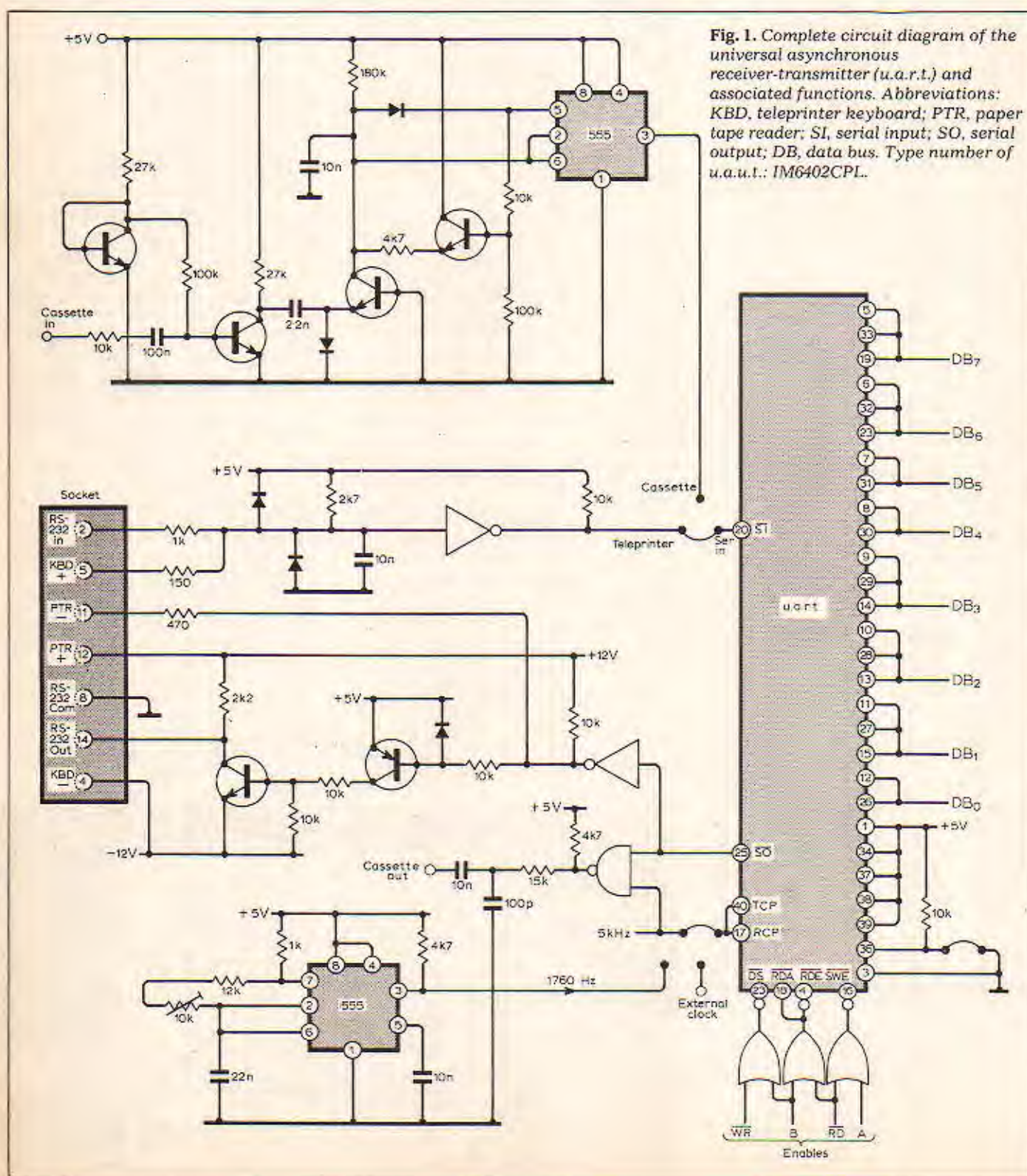

Fig. 1. Complete circuit diagram of the universal asynchronous receiver-transmitter (u.a.r.t.) and associated functions. Abbreviations: KBD, teleprinter keyboard; PTR, paper tape reader; SI, serial input; SO, serial output; DB, data bus. Type number of u.a.u.t.: IM6402CPL.

THIS MONTH the description of those peripherals of the microcomputer system outlined in the January issue is completed by a circuit diagram of the universal asynchronous receiver-transmitter (u.a.r.t.). As explained last month, the purpose of the u.a.r.t. is to provide a transformation between the 8-bit parallel data within the computing system and the type of serial digital information which can be handled by peripheral devices such as the audio cassette recorder. The u.a.r.t. is shown in Fig. 1, and it will be seen that this has connections to the 8-bit data bus of the computer system on the right (labelled DB_0 to DB_7) and connections for the serial input and output information on the left (labelled SI and SO, negated).

Clock arrangements

As also mentioned last month, the rate at which the data is shifted into and out of the u.a.r.t. is determined by a clock pulse signal applied to the receiver and transmitter clock connections on the u.a.r.t. (pin 17, labelled RCP, and pin 40, labelled TCP). There are in fact three clock pulse generators available to the system. The first of these is provided elsewhere in the computer by a crystal oscillator and divider chain, which produces a 5kHz clock signal, and this is fed to the u.a.r.t. by a link as shown at the bottom of the diagram. The second clock generator is a circuit at the bottom left of Fig. 1. This is a simple oscillator based on a 555 i.c. which can be adjusted to operate at 1760Hz, and as shown this signal can be fed to pins 17 and 40 on the u.a.r.t. by means of the link. The third clock generator is any external source the user may care to apply, and this again is fed into pins 17 and 40 on the u.a.r.t. by the link as shown at the bottom right.

As already mentioned, since a stop bit and a start bit are added to the byte, there are 10 bits in each word transmitted. This, however, can be increased to 11 bits by adding another stop bit, which can be done by applying $-5V$ to pin 36 on the u.a.r.t. by means of the 10k Ω resistor and removable link.

Serial digital information is recorded on the audio cassette recorder in the form of a modulated tone. This tone is provided by the 5kHz clock signal shown in Fig. 1, which is modulated by gating it with the serial data emerging from SO on the u.a.r.t. The resulting modulated 5kHz signal goes to the "cassette out" terminal. The playback signal from the cassette recorder (applied to the terminal "cassette in") is therefore a series of bursts of 5kHz tone corresponding to the serial data stream. To convert these tone bursts back to conventional logic levels there is a tone detector circuit. This is shown at the top of Fig. 1, and is made up from a 555 i.c. and associated components.

The serial input to the u.a.r.t. is connected by a link to whichever source is chosen by the user.

Peripheral 4—visual display

In any computer system of this type it is required that the user be presented with data from the machine. For programme development this may mean the presentation of several hundred characters. At the same time the cost of displaying alphanumeric characters should be minimised. The method chosen for this project is a "memory plane peripheral" and is not sited on ports as conventional i/o but consists of logic which shares a section of the memory. This logic is designed to pre-

sent a composite video signal to a domestic television receiver in such a way that the contents of this memory section are interpreted as characters. Any possible conflict of access to the memory between the processor and the logic has been resolved by giving the processor absolute priority. As a concession to appearance the video signal is blanked during c.p.u. access. It is as though a section of memory is exactly mapped on to a visible plane.

(To be continued)

continued from page 50

one alumina substrate. Anodised aluminium capacitors ranging from 2 to 400pF, and nichrome resistors ranging from 4 to 200 Ω , are used.

Acknowledgements

The authors would like to thank their colleagues at the Mullard Research Laboratories, whose work has been illustrated in this article. Particular thanks are due in this respect to Mr P. L. Booth, Mr L. W. Chua, Mr K. Holford, Mr R. E. Pearson, Mr S. K. Salmon, Dr H. Sewell and Dr J. C. Williams. The work on the parametric amplifier and the microwave receiver was supported by the Procurement Executive, Ministry of Defence.

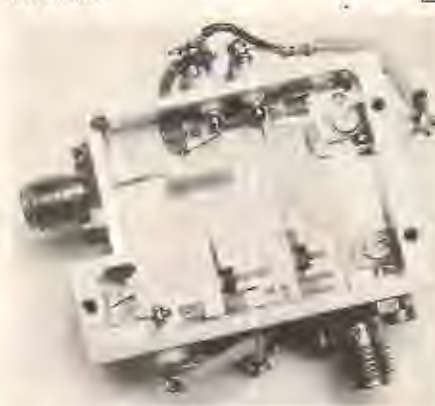

Fig. 10. A 900MHz transistor amplifier.

References

1. Caulton, M., Knight, S. P., Daly, D. A., Hybrid integrated lumped element microwave amplifiers, *IEEE Trans. Electron Devices*, Vol ED-15, July 1968, pp. 459-466.
2. Aitchison, C. S., Davies, R., Higgins, I. D., Longley, S. R., Newton, B. H., Wells, J. F., Williams, J. C., Lumped-circuit elements at microwave frequencies, *IEE Trans. Microwave Theory and Techniques*, Vol MTT-19, Number 12, Dec. 1971, pp. 928-937.
3. Wheeler, H. A., Transmission-line properties of parallel strips separated by a thin sheet, *IEEE Trans. Vol. MTT-13*, 1965, pp. 172-185.
4. Schneider, M. V., Microstrip dispersion, *Proc. IEEE (special issue on computers in design) (letter)* Vol. 60, Jan. 1972, pp. 144-146.
5. Harvey, A. F., *Microwave Engineering*, Academic Press, 1963, p. 445.
6. Newton, B. H., Pearson, R. E., Williams, J. C., The design and realisation of m.i.c. subassemblies on ferrite substrates, *IEEE Trans. Magnetics*, Sept. 1975.
7. Caulton, M., Film technology in microwave integrated circuits, *Proc. IEEE*, Vol. 59, 1971, p. 1481-1489.
8. Funk, W., Shiltz, W., Thick film techniques for hybrid integrated microwave circuits, *Proc. of conference on hybrid microelectronics*, University of Kent, England, Sept. 1973, p. 129.
9. Pearson, R. E., A cheap, low noise (2.5dB) X-band amplifier, *Proc. of AGARD Conference*, The Hague, June 1976, p. 2-1.



Fig. 9. An integrated X-band Doppler receiver.

Mysteries of Sporadic E

JUST why and when those curious clouds of ionization form some 100km above the Earth — the Sporadic E (Es) phenomenon — is still one of the unsolved mysteries of radio physics. In the UK, there is a pronounced Es "season", in other countries nearer the Tropics, such as India, the Es paths can open almost daily. Such conditions provide v.h.f. paths up to almost 2000km and very occasionally "two-hop" paths can double this maximum distance. Amateur exploitation of Sporadic E dates back to the 1930s and I remember the sensation when E. Menzies, G5MQ, in Liverpool first worked an Italian station on 56MHz on July 2, 1938 shattering previous conceptions of v.h.f. distances. Today such contacts are accepted as a normal part of the Es and tropospheric scene. But if more was known of the basic mechanisms that give rise to the ionized clouds, it might be possible to predict in advance just when they are likely to occur.

Regular observations made over a number of years by Ron Ham at Storrington, Sussex show that although the 1977 Es season was a little shorter (May 4 to August 5) than in 1976, it was observed more frequently (in the range 65 to 73 MHz) than in any of the previous four years. June 1977 showed 16 disturbances, representing more than half the days of the month. But Ron Ham is still unable to prove or disprove any direct connection between sunspot activity and Es disturbances.

Martin Harrison, G3USF, however, believes there may be a connection between the onset of an Es disturbance and the strange phenomenon of "sweepers"; atmospheric phenomena that are observed to sweep rapidly over a frequency spectrum several megahertz wide in a matter of seconds and are heard most frequently between about 25 and 30 MHz (though occasionally as high as 150MHz or as low as 2MHz). Sweepers were first reported by the Americans N. C. Gerson and W. H. Gossard in 1958 and more recent observations have been made by A. K. Sen and S. K. Trehan of the University of Calcutta aided by a number of observers including VU2KX at Berhampore and VU2SA at New Delhi. Both these studies have suggested a firm link between "sweepers" and the sun; but the possible link with the onset of Sporadic E conditions appears to have been suggested for the first time by Professor Harrison, G3USF.

Three European 50MHz beacon stations, ZB2VHF (50.090MHz) in Gibraltar, FX3VHF (50.100MHz) in France and 5B4CY (50.140MHz) in Cyprus should all be in operation by the time these notes are published and should provide an excellent opportunity, particularly for amateurs in southern Africa, for transequatorial propagation.



News and views

"Oscar 6 is dead. Long live Oscar 7" that is the gist of the latest communique from the University of Surrey AMSAT Telecommand. Martin Sweeting, G3YJO reports that following cell failure in the Nicad battery of Oscar 6 last June, the spacecraft was shut down indefinitely. Soon afterwards the downlink telemetry became garbled and the satellite failed to respond to ground command, the transponder falling silent a week later. Although the telecommand station continued to track Oscar 6 it was heard only briefly on two occasions and now, after some 4½ years of operation, must be considered dead. Oscar 7 continues to function well although more orbits are being switched to Mode B where the battery drain is greater, so easing the problem of almost total sunlight at this time of the year. Unfortunately some operators continue to use excessive uplink powers on 432MHz: 100W e.r.p. is recommended, 10W may be enough.

In several West European countries, including Germany and Holland, a number of amateur stations are now using rejuvenated Hellschreiber ("Feldfernschreiber") machines on 3.5MHz producing curious matrix-type tapes of written messages. The Hellschreiber system, which produces a distinctive rhythmic "grinding" signal, was used by the Germans in World War 2 and subsequently by news agencies.

Almost fifty repeater stations are now operational in the UK. The UK FM Group (Western) recently brought two more u.h.f. repeaters into operation on 433MHz. GB3CR operates from Pont-y-Bodkin, Mold, Chester, serving Chester and parts of the Wirral; GB3LI operates from Seaforth serving the City of Liverpool and the whole of Merseyside. It is also hoped to build an amateur tv repeater for the 1.3GHz band and the r.f. equipment for this is already being assembled. The Group secretary is Gordon Adams, G3LEQ (2 Ash Grove, Knutsford, Cheshire WA16 8BB). A man was recently successfully prosecuted in Corwen Magistrates' Court by the

Home Office in a case which arose out of jamming and abuse of the Moel-y-Parc repeater. Local amateurs located by direction-finding the unauthorised transmitter. The report (WoAR, December) that the UK FM Group were considering closing down GB3LO is wrong; it appears to have originated in the "dirty tricks department" of an anti-repeater group.

The gigahertz president

ON Saturday, January 21, Lord Wallace of Coslany will install as his successor, the 44th president of the RSGB, Dain Evans, Ph.D., G3RPE.

Dr Evans is known and respected for his tremendous enthusiasm for encouraging more amateur operation in the microwave bands above 1GHz, with the 10GHz band as his own special interest. In October 1970 he launched the first regular monthly column to appear in any amateur journal specifically devoted to the world of the gigahertz. As a result, he has seen interest and activity grow steadily in the UK, and more recently in many countries throughout the world.

But his first experiments with radio, though showing the same ingenuity that led him to examine dozens of different dustbin lids to test their suitability for use as microwave reflectors, was on far more mundane frequencies. As a ten-year-old schoolboy he invested 6d in a pair of government-surplus headphones and made a crystal set using the "blue" on a Blue Gillette razor blade as the detector.

In September 1969 he first contacted a French 10GHz station across the English Channel on Cape Griz Nez while using 15mW s.h.f. power to a 10-inch dish aerial. But he recalls as his most interesting operation "sitting on a beach in Holland chatting to English amateurs while using only 2mW on 10GHz." His ambition is to make some 1000km contacts on this band.

In brief

The ITU has allotted the callsign series P4A to P4Z to Netherlands Antilles . . . Eric Hubbard, G50X, often known as "Oxo," has died; he was one of the amateurs who in the early 1920s were allowed to operate on 440 metres . . . Another old-timer who has joined the "silent keys" is Reg Radford, G2IM, who began his many years with BBC Engineering in the days of 2LO . . . A television receiver designed to operate without interference in strong r.f. fields has been built for the FCC by Texas Instruments and is attracting considerable interest . . . The Home Office has resumed the issue of "special event" licences, including GB3MSA for the Poldhu station participating in the KMICC 75th anniversary until January 22.

PAT HAWKER, G3VA

Automatic impedance plotter

Finding impedance variations at 20MHz in surface wave transducers

by T. F. North, Physics Department, Chelsea College, University of London

A problem that often arises in electro-acoustical work is the need to know the electrical impedance of a component under specific operating conditions and its variation with frequency. In stimulating nematic liquid crystals with mechanical surface waves in particular, I needed to know how the impedance of an inter-digital surface-wave transducer varied with frequency in the range 18 to 70MHz.

MEASURING IMPEDANCE variations of a component is a straightforward procedure using a standard radio frequency bridge. But a large change within a narrow frequency range makes an automatic plotting system more appropriate. In the circuit of Fig. 1 R is a standard resistor of negligible inductance and peak-to-peak potentials V_1 and V_2 at both terminals of the resistor are measured. Provided the phase change across the component under test is small, it follows that its impedance is $|Z| = V_2 R / (V_1 - V_2)$. As an initial step a method was sought of varying the signal strength to maintain $(V_1 - V_2)$ constant. The use of f.e.t. attenuators introduced distortion into the waveform and so an alternative procedure was adopted of attenuating the average signal level by chopping the continuous-wave signal with a variable mark-to-space ratio.

The wideband gate employed to chop the r.f. signal is given in Fig. 2. With the gating input in the up position, the diodes are all reverse-biased and so there is no signal transmission. On putting the gate input down, the diodes become conducting so that the input and output potentials must now both be one diode-voltage drop above and below the respective junctions between the diodes and resistors; hence the gate will allow the passage of the signal.

Such a system of gating the r.f. signal worked satisfactorily but a simpler procedure is to measure V_1 and V_2 and then attenuate both by the same proportionality factor α so that $\alpha(V_1 - V_2)$ remains constant; Z is now proportional to αV_2 . This proportional attenuation is achieved by chopping both voltages with a variable mark-to-space ratio of $\alpha(1-\alpha)$ and integrating

the resulting wave to produce the voltages αV_1 and αV_2 , Fig. 3.

Negative voltages $-V_1$ and $-V_2$ are measured by detection in D_1 and D_2 and the outputs from these diodes fed into voltage follower operational amplifiers IC_1 and IC_2 to provide a high input impedance to the system. There is no need to smooth the detected signal. The frequency range under study being well outside the frequency range of the 741 op-amp. Diodes D_3 and D_4 introduce an offset in the voltages between the inputs and outputs of these voltage followers equal and opposite to the voltage drops across D_1 and D_2 . Potentials at the outputs of IC_1 and IC_2 are thus equal to $-V_1$ and $-V_2$.

When the output of IC_3 is saturated negatively diodes D_5 and D_6 are reverse biased and the voltages at points A_1 and A_2 will be $-V_1$ and $-V_2$ respectively. However, when the output of IC_3 is saturated positively D_5 and D_6 will raise the potentials at A and B until D_7 and D_8

conduct. The voltage drops across these diodes are balanced by that across D_9 so that points A_1 and A_2 will now be at zero potential. The voltages at points A_1 and A_2 are integrated by R_9 and C_1 and R_{10} and C_2 respectively to give voltages αV_1 and αV_2 . The last-mentioned voltage αV_2 is amplified in the unity-gain voltage follower IC_4 to provide a low impedance output. A constant voltage of 2.7V is added to it by the zener diode, fed by constant-current source, and the resulting voltage compared with $2V_1$ in the differential amplifier IC_5 . Capacitive negative feedback across this amplifier limits its frequency response to well below the chopping frequency and renders the system stable. The output of this amplifier is used to vary the chopping mark-to-space ratio, $\alpha(1-\alpha)$.

Positive feedback through R_{14} causes IC_6 to oscillate at a frequency of approximately 10kHz. Capacitor C_4 is continually charging or discharging through R_{15} so there is a triangular

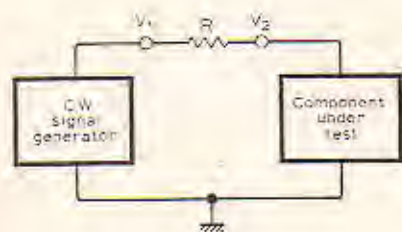

Fig. 1. Impedance of component is plotted by attenuating average signal level through it. A chopped e.w. signal with variable mark-space ratio can achieve this.

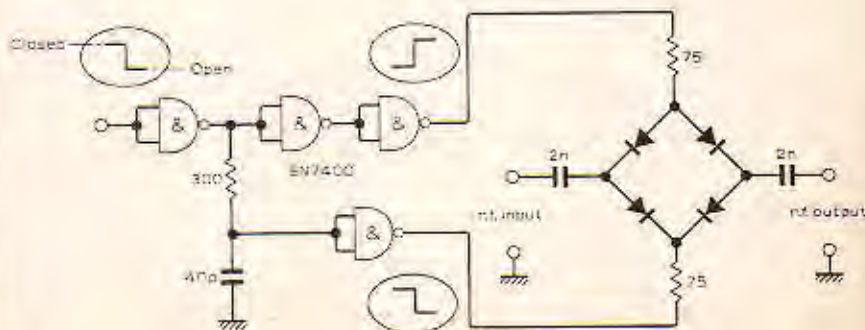

Fig. 2. A variable amount of r.f. signal can be passed through a standard resistance using a single wideband chopper, avoiding the distortion of an f.e.t. attenuator.

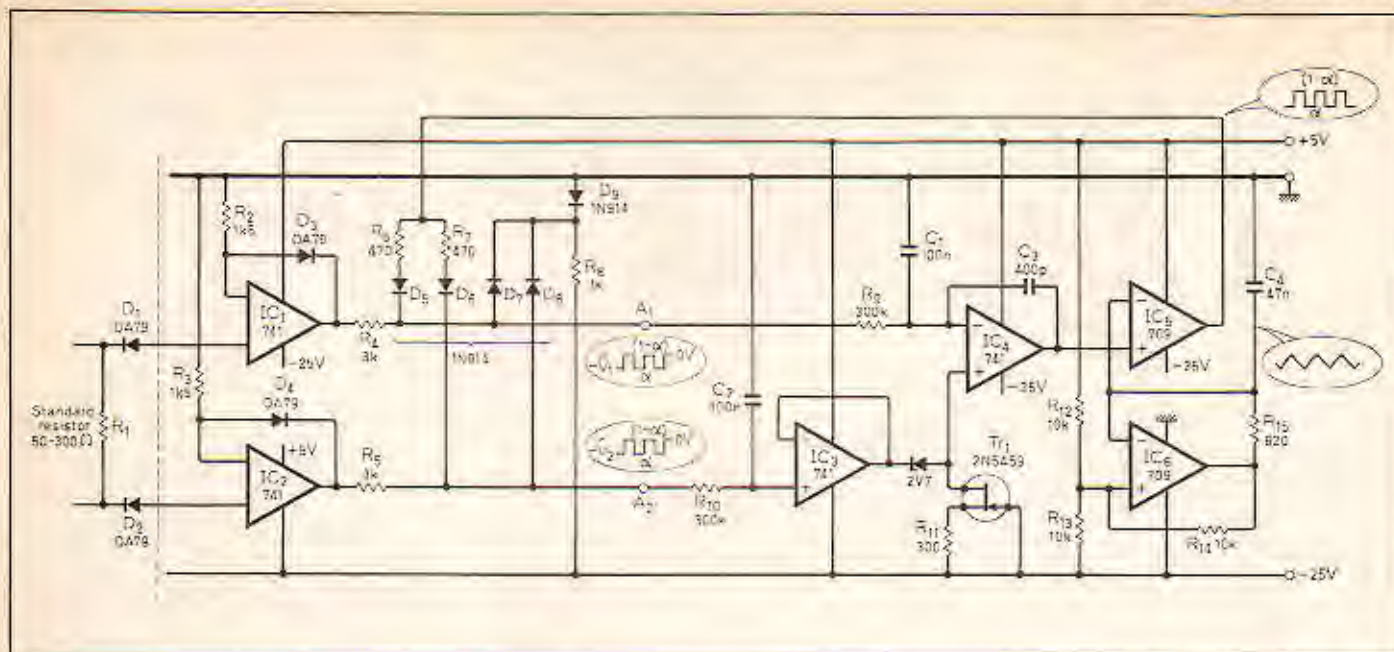

Fig. 3. Same attenuation of V_1 and V_2 is obtained by chopping both with a variable mark-space ratio of $\alpha(1-\alpha)$ and integrating to produce αV_1 and αV_2 .

wave at their junction, which is fed into one input of the saturating amplifier IC₅. The points at which the voltage level at its other input cut this triangular wave determine the moments at which it changes from saturating at one polarity to the other. Accordingly this voltage level determines the mark-to-space ratio of its output.

Procedure for plotting the impedance of the transducers in question is to slowly sweep through the frequency range of interest by changing the

output frequency of the signal generators by hand. The X input of an XY plotter is driven by a frequency-to-voltage converter consisting of a commercial 1:100 frequency divider, which

triggered a μ s monostable unit (SN74121). The integrated output of this is proportional to frequency. The Y input of the recorder is driven by the output of IC₃, and point A₁ of the circuit monitored with an oscilloscope. This enables both the detected signal level V_1 and the mark-to-space ratio of the chopping to be seen. In practice the signal level can be set so as to maintain this ratio at about unity. The system is calibrated by using carbon resistors of known value.

Turntable war, first casualties

Garrard and Strathearn are in trouble. Strathearn's autocratic chief executive, Graham Bish, has been relieved of his duties as executive chairman, though he remains a director. The reason given was of ill-health. The company has now swallowed at least £7 million of taxpayers' money, and as the rest of the turntable industry produces ever newer models the Strathearn units are as they were four years ago.

Recently Strathearn asked the Northern Ireland Development Agency for further funds "to develop its marketing operation and future production capacity," according to a spokesman. The NIDA declined, and called for an examination of Strathearn's viability. The subsequent report showed that the company could not survive, and it appears that the Minister of State for Northern Ireland is not prepared to intervene to keep the firm going. However, the directors have been given a period of grace to prepare a case for keeping Strathearn open.

Garrard, by comparison, look like paragons of efficiency. All the same, 480 jobs are to be lost of which 335 are indirect labour, such as cleaners and clerical staff, and 145 are directly employed in making turntables. Of the 145, a large number are working shifts, so the total of direct labour redundancies could be as high as 290. The total workforce is 2,000.

There are several reasons for Garrard's plight. One is the depressed home market.

According to BREMA, "There is little sign of the anticipated seasonal pickup." Any disposable income people have left after inflation and wage freezes have taken their toll is being spent on something other than hi-fi.

Even if there had been a normal pre-Christmas rush, however, Garrard say they would not have been ready. Production of the new range, for which they would have had to start taking trade orders at Harrogate at the beginning of September, didn't start until the end of October, two months behind schedule. They blame poor deliveries of components, including some from Japan, and, privately, poor labour relations.

However, there seems to have been very little labour trouble at Garrard's, which the local union representatives say has better wages and working conditions than most factories in the district. The local organiser of the AUEW told *Wireless World* that in the four years he had been in Swindon he could only remember having to go there once, and that was over a small matter that was easily resolved. The unions add that, as soon as Christmas is over they will want to look at the books, but they have little doubt that they will find the main cause of the lay-offs was lack of consumer demand.

That does not appear to have affected the Japanese makers, who, Garrard complain, went on the offensive, taking large ads in the colour supplements. One wonders what was to prevent Garrard doing the same.

Last July Garrard held a press lunch at which they previewed the new range. Managing director Derek Moon made clear his attitude to Japanese imports: "This industry used to employ 48,000 people more than it does now... Protect your home industries, I say to government, and if that means tariffs for a while then let's have a tariff barrier. I do want a breathing space from Japan Inc. Give us a couple of years and we'll beat the hell out of them too."

Garrard has suffered quite a bit at the hands of the Japanese. In 1972 they had 17½% of the world turntable market. By 1976 that had dropped to 7½%, though they say they have managed to hold their share this year. Together Garrard and Plessey had invested £2.5 million in new products in 2½ years, though they admitted to mistakes. At the July preview they said, "Cosmetically last year's range didn't match up."

There are signs, as we pointed out in our Harrogate report (November 1977, p.57) that this year's don't match up either. The collapse of the home market hardly explains the troubles of a company that exports 70-80% of its production. The European and American markets have not been so depressed. A company that wants relief from the pressures of competition is in trouble, whether it knows it or not. BSR's Roger Allan, who lived in Japan for many years, told us in an interview last year "I'm totally for free trade. If the world went protectionist it would be a disaster." □

KEEP YOUR COOL

WITH ANTEX SOLDERING IRONS...

THIS UNIQUE SAFETY STAND - PART OF THE ANTEX SOLDERING KITS SK3 and SK4



Stand S.T.3
... has a chromium plated steel spring and is suitable for all our models
Priced at £1.75 inc. VAT & P&P

With the new Antex soldering stand you have the assurance that with the iron tucked neatly into the strong angled spring coil you have maximum safety when preparing or waiting for the iron to heat. Moulded into this stand is provision for six alternative bits, and two small sponges for cleaning bits.

This sturdy plastic stand is a useful addition to any household or workshop. The SK3 and SK4 kits comprise of a full instruction card mounted with either the CX miniature soldering iron or the larger X25 general purpose iron. Included in both of these kits is the safety stand.

All the range of Antex soldering irons are made on the principle of putting the heating element inside a shaft, then the desired bit is eased over the shaft, giving maximum heat transference, this is why so often a small Antex iron can do the job of a larger conventional iron. The precision made slide on bits are slit to make them easily interchangeable.

Our comprehensive range is sure to meet your need.

Model CX-17
watts

... a miniature iron with the element enclosed first in a ceramic shaft, then in stainless steel. Virtually leak-free. Only 7 1/2" long. Fitted with a 3/32" bit £3.91 inc. VAT & P&P. Range of 5 other bits available from 1/8" down to 3/64"

Model X25-25 watts

A general purpose iron also with a ceramic and steel shaft to give you toughness combined with near-perfect insulation. Fitted with 1/8" bit and priced at £3.91 inc. VAT & P&P. Range of 4 other bits available.
B.E.A.B. APPROVED

Model SK3 KIT

Contains both the model CX soldering iron and the stand S.T.3. Priced at £5.52 it makes an excellent present for the radio amateur, model-maker or hobbyist.

Model SK4 KIT

With the model X25 general purpose iron and the S.T.3 stand and its B.E.A.B. safety label, this kit is a must for every toolkit in the home.

Model SK1 KIT

This kit contains a 15-watt miniature soldering iron, complete with 2 spare bits, a coil of solder, a heat sink and a booklet, "How to solder." Price £6.18 inc. VAT & P&P.

Model MLX KIT

The soldering iron in this kit can be operated from any ordinary car battery. It is fitted with 15 feet flexible cable and battery clips. Packed in a strong plastic envelope it can be left in a car, a boat or a caravan, ready for soldering in the field. Price £4.59 inc. VAT & P&P.

Stocked by most of the well-known wholesalers and many retailers. Or direct from us if you are desperate



Please send the following I enclose cheque P.O. Giro No258 1000

Name

Please send the ANTEX colour brochure Address

ANTEX LTD. FREEPOST, PLYMOUTH PL1 1BR TEL. 0752 67377

WW 2 78

WW-067 FOR FURTHER DETAILS

The measure of our success.

D210 Digital Multimeter £130



Auto ranging
LCD display up to 5999
A C measurements up to 20KHz

Signal Injector £8.50



Useful for both valve and transistorised equipment.
Frequencies up to 500MHz VHF & UHF.
Pen type style.

Transistor Tester £33.50

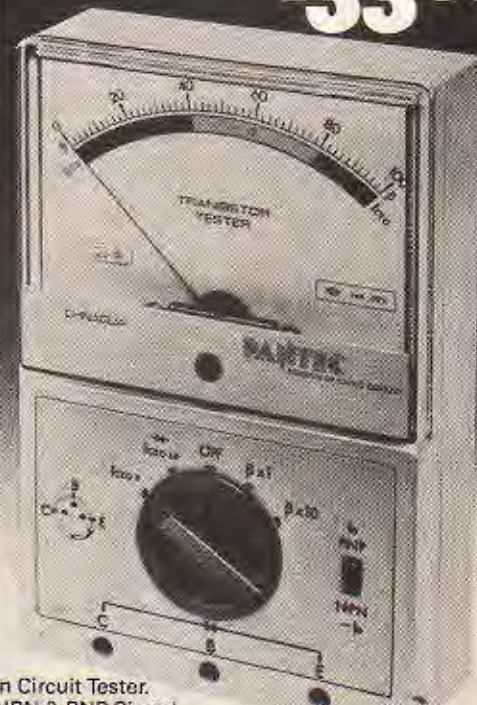

In Circuit Tester.
NPN & PNP Signal
& Power Devices. Clear Colour Zone Scale.

DOLOMITI Special £42.36



Cut out protection
1500V AC/DC 5A AC/DC
Resistance 50M ohm 20K ohm/V

OX712 Scope £300



Dual trace 15MHz Oscilloscope! Sensitivity 1mV (max)
Full 8cm x 10cm display Finger tip SY NC, TV, YA, YB mains external

Precision Instrument Laboratories have rapidly become the most comprehensive instrument stockist in the U.K. Shown above are just 5 of the instruments that we have available for the radio and television engineer.

Our full range includes Field Strength Meters, Valve Testers, Logic Probes and generators function, signal, cross hatch and colour bar.

Instruments Electrical Co. Ltd., the repair associate company of PIL offer a complete repair service on all electrical and electronic measuring instruments.

Precision Instrument Laboratories, Instruments Electrical Co. Ltd,
Instrument House, 212 Ilderton Road, London SE15 1NT.
Tel: 01-639 0155.

Items illustrated may be purchased by enclosing a cheque for amount shown.

PIL IEC

IEC GROUP COMPANIES

Products are also available
from PIL Ltd., North London 01-965 2352 and
Smith & Cookson, Liverpool 051 709 3154

Plus carriage and VAT 8%

Topics from Radar 77 — 2

Further extracts from the IEE conference

by Ray Ashmore

The last issue summarized six papers from the international radar conference, Radar 77, which this year was organised by the IEE. The papers included descriptions of a man-portable radar, and radar systems for automatic collision avoidance and the detection of sea states and oceanic winds. The following text is also based on extracts selected from the conference papers.

AT A WAVELENGTH of 10 μ m, one has the option in radar of using either photodetection or radio-frequency detection using metal-oxide-metal point contact diodes. Comparisons by the Royal Signals and Radar Establishment at Malvern have shown that, assuming all radiation entering these detectors is 'signal', for heterodyne detection the signal-to-noise ratio performance with r.f. detection is 'everywhere better' than with photodetection. For photodetection the signal noise is proportional to the incident field, but for r.f. detection it is proportional to the power. For both systems, performance is greatly improved by using heterodyne detection at the receiver. In practice one can achieve a receiver performance in which background fluctuations are the dominant noise source in the receiver system.

Harmonic radar detection

Plessey Radar Research Centre have been investigating systems using harmonic radar detection⁹. The difference between harmonic radar and conventional radar is that the receiver detects radiation generated by the target at frequencies which are harmonics of the incident radiation frequency. Many man-made objects generate harmonic frequencies when illuminated by a radiation flux, but most natural objects such as vegetation, the ground and the sea do not. However, the frequency conversion efficiency from the man-made objects usually restricts applications to relatively short range detection systems.

The main advantage with harmonic radar is that it is free from environmental clutter. Harmonic generation arises from non-linearities in the electromagnetic transfer characteristics in objects such as semiconductors, and metal-to-

metal junctions. Further information regarding the theory of harmonic radiation can be obtained from the May and June 1974 issues of *Wireless World*.

For a semiconductor diode the transfer characteristic is exponential and results in a rich harmonic spectrum. Since it has been found that the conversion loss is less for low harmonics, for the most favourable range law, a second-harmonic receiver should be used. For a typical metallic target, because the transfer characteristics are symmetrical and the power series contains only odd-order terms, the receiver must be a third harmonic type. Results confirm that the third harmonics received from metallic targets are much lower than the second harmonics from electronic targets.

Non-linearity in metal junctions is thought to arise from, among other things, electron tunnelling through the oxide barrier existing at the metal surfaces. This non-linearity, however, is sensitive to small movements of the contact surfaces. This causes the harmonic signals to fluctuate and make it impossible to give a fixed value of harmonic 'cross-section' to the objects, except by using a statistical definition. The observed cross-sections have been found to vary considerably for different types of object.

Applications for harmonic radar include collision avoidance, locating targets close to the surface of the sea and non-destructive testing, to locate the presence of cracks in metal structures.

Radar in geophysical prospecting

The use of radar for detecting and locating subsurface geological strata and man-made artefacts has recently received considerable attention in technical reports, particularly in the USA. For this application, conventional a.m./c.w. has been found to be the most suitable for long range prospecting. For short range prospecting, f.m./c.w. was found to require highly complex receivers, especially at frequencies below about 1GHz, and consequently other modulation techniques had to be developed.

One of these techniques, pseudo-baseband pulse radar, was the subject of a paper¹⁰ presented by the Plessey Radar Research Centre. There are two

methods of generating pseudo-baseband pulses. One method transmits a discrete harmonically-related spectrum related to a pulse train, and depends upon a computer processor to reconstruct the received information into the time domain. The other method, which is suitable for portable radars, uses a pulse generator providing a real time pulse train. The latter method was used by the Plessey team investigating subsurface interfaces between strata, and has resulted in a number of short-range high-resolution radars being developed.

In general, the pulse generator produces a cosine squared function having a time duration between 0.5 and 10ns, depending on the application. The return signals from the interfaces are passed through a sampling head and translated from the nanosecond time region to the millisecond time region.

The antenna is a critical element in the design because clutter greatly reduces the system dynamic range. Most applications require the antenna to be operated well clear of the front surface of the radar. The radar is then physically moved to scan the target and the signal return is stored for analysis.

In the field trials a series of laboratory measurements were carried out at frequencies from 100MHz to 15GHz on coal and slate samples from South Derbyshire. From these measurements it was concluded that the attenuation characteristics of UK geological materials tend to be significantly higher than those reported by other authors and that, as expected, water content and impurity level are the functions of material attenuation. In addition the results showed that the antenna design feature used, a successive subtraction technique, has enabled a significant improvement in the dynamic range which can be achieved.

Detection of buried objects

One paper¹¹ from the Queen Mary College, University of London, proposed the use of f.m./c.w. radar for the detection of buried objects such as pipes and cables, some of which may be plastics. In the latter case conventional metal detectors fail. A prototype radar developed by the investigators at the College operated in a linearly-swept frequency band from 2 to 4GHz. With

this system, which is potentially man-portable, small plastic objects were detected at depths of about 25cm in wet sand. For polystyrene foam buried in sand vertical and horizontal resolutions of about 4 and 20cm respectively have been achieved.

The choice of operating frequency was a compromise. A low microwave frequency improves ground penetration but limits resolution because, for a constant-aperture antenna, the ground illumination increases as the frequency increases, and for a constant percentage swept bandwidth the range resolution decreases as the centre frequency decreases.

The antenna needed to have a radiation pattern with a relatively narrow beam width at the ground surface, and one that remains relatively independent of frequency over the swept band. It also had to have a low input v.s.w.r. which was either frequency independent over the band or exhibited a desired variation. In addition, the antenna pattern needed to have low side-lobes and the antenna had to be compact.

It was concluded that improvements in system performance should be achieved by using a bistatic system having a microwave amplifier following the receiver antenna. Signal processing techniques could also be used to further reduce range side-lobes associated with the ground returns, and, where the antenna is at a constant height above the ground, cancellation techniques could be attempted. These features would certainly be required if the radar is to detect objects buried in clay soil at depths in excess of 20cm.

The detection of electricity pylons and cables

The potential hazard of light aircraft and rotary-wing aircraft striking electricity cables has long been the concern of military aviation authorities in many countries. As a result, the role of such aircraft is severely restricted, particularly in darkness or bad weather conditions. Line cables may be detected by the interference generated by them, but if the cables are not current-carrying they will not be seen by the aircraft. The Research Laboratory of Marconi-Elliott Avionics Systems Limited, on behalf of the Royal Signals and Radar Establishment, has been investigating the possibilities of detecting pylon cables by radar¹². It is possible by using a simple pulsed radar, generating at short centimetric or millimetric wavelengths for example, to detect a straight power cable at several points along its length. The detection points will be a main return (broadside flash), which is normal to the cable and is due to the cable acting as a cylindrical rod, and a secondary return which is detected on either side of the broadside flash, and is due to the wrapped construction. Tertiary detection points could also be detected at an angle of approximately 40° to nor-



Hughes' US Army Firefinder radar AN/TPQ-36 can locate artillery after only one firing and predict target location before impact.

mal, but these could be observed only at very short ranges. It was decided that a Q-band, experimental pulsed radar should be used, operating at approximately 35GHz. The radar used a high powered magnetron transmitter with a pulse length of 100ns and a p.r.f. of 200 pulses per second. The aerial system had a flat plate Cassegrain scanner with a 3dB bandwidth of approximately 1° and it could be mechanically scanned over several degrees in both elevation and azimuth planes. Using this radar, targets as close as 150m could easily be detected.

The field trials showed that it is possible to detect power cables by using pulsed Q-band radar equipment, and that the magnitude of the broadside return is similar to that produced by the supporting pylon. The fact that, in a plan presentation, the secondary returns all lie on the same straight line as the broadside return and the two adjacent pylons, is considered an advantage to a pilot in discriminating between cable returns and those from trees and other more randomly spaced obstacles.

Radar on the battlefield

A radar system has been developed by the US army to determine automatically the location of hostile artillery after it has fired only once¹³.

The system, called Firefinder, is designed to locate simultaneous fire from numerous weapons on a battlefield. It employs two different radars, types AN/TPQ-37 and AN/TPQ-36, which both employ electronic scanning antennas enabling rapid repositioning of the antenna beam anywhere over a 90° azimuth sector. They will also scan a few degrees in elevation.

The AN/TPQ-37 has successfully located artillery in live fire tests at ranges beyond 30km. Phase shifter devices in its phase scan system are integrated into modular arrays that include stripline power dividers and dipole radiating elements. The final power

amplifier in the system's transmitter is a travelling wave tube controlled by a shadow grid and, in each position, the transmitter is pulsed at a fixed p.r.f. to form a train of coherent pulses. The radar receiver uses a gallium-arsenide, f.e.t. preamplifier for each of the pulse channels. After frequency conversion, the channels are time-multiplexed into a single channel by using s.a.w. delay lines. The train of pulses is then coded by frequency modulation and the f.m. signal transmitted to the operations shelter over coaxial cable at its intermediate frequency.

The AN/TPQ-36, which also scans in azimuth and elevation, has a range approximately half that of the AN/TPQ-37. It used a series end-feed to distribute the r.f. power in the horizontal plane and ferrite phase shifters to electronically scan in azimuth. For elevation scanning, r.f. power is disturbed through individual waveguides which have radiating elements in the form of slots cut in the narrow walls. Electronic scanning is carried out using the frequency dispersive characteristics of the waveguides by changing the radiated frequency. The transmitter and receiver systems are similar to those in the AN/TPQ-37.

Each radar scans the horizon of the surveillance sector, with a single row of beams searching the sector a few times each second. Targets are tracked by updating measurements of range, azimuth, elevation, doppler and amplitude several times each second. When there are multiple targets, each target is tracked for a few seconds and time-related to the search process. The system discriminates between returns to reject those done to birds, aircraft and other sources of clutter.

The weapon-locating process is so rapid that the position of the hostile artillery is usually determined before the projectile impacts. The radar system computer can also extrapolate forward along the trajectory to indicate to the operator the expected impact point as well as the artillery position.

References

- All to Radar 77, IEE Conference Publication 155.
- Oliver, C. J., Royal Signals and Radar Establishment.
- Fleming, M. A., Mullins, F. H., Watson, A. W. D., Plessey Radar Research Centre, Harmonic radar detection systems.
- Daniels, D. J., Plessey Radar Research Centre, The use of radar in geophysical prospecting.
- Clarricoats, P. J. B., Queen Mary College, University of London, Portable radar for the detection of buried objects.
- Harris, D. S., Marconi-Elliott Avionic Systems Limited, The detection of electricity pylons and cables by radar.
- Ethington, D. A. Hughes Aircraft Company, Ground Systems Group, Fullerton, California, The AN/TPQ-36 and AN/TPQ-37 Firefinder radars.

Single-sideband transceiver design

Underground application uses simple ceramic sideband filter

by B. A. Austin, B.Sc. (Eng.)

Research Laboratories, Chamber of Mines, Johannesburg

An investigation of underground radio communication showed the need for a transceiver operating at around 1 MHz and with an r.f. power capability of 1W. The requirements of such a transceiver are considered and certain circuit details discussed.

For underground use, a suppressed-carrier modulation system must be used to obtain maximum usable transmitter power, and a double-sideband suppressed carrier transmitter is simple to design, adjust and manufacture. Reception of d.s.b. s.c. signals with fairly simple detectors, however, presents a problem. Use of a single sideband, on the other hand, does not require such complication in the receiver but does require a more complex transmitter. Of three commonly-used s.s.b. generation systems, only the filter method does not require careful circuit adjustment. Because filter-type s.s.b. generators are expensive it was necessary to examine other possibilities, particularly in view of the environment.

Transceiver requirements

The transceiver was required for operation in deep gold mines, shielded from surface noise by a mass of rock impervious to electromagnetic propagation. There is no channel congestion in this environment, and this makes it possible to accept transmitter characteristics which would be non-ideal elsewhere. Most important of these is the generation of an s.s.b. signal by the filter method which is of sufficient quality to simplify the receiving circuitry, but does not require excessive rejection of the unwanted sideband. Acceptance of this immediately simplifies the requirements of the sideband filter.

A ceramic filter element appeared to be suitable and the manufacturer's specification for a single-section filter type SFD-455B is shown in Table 1.

Table 1. Single-section SFD-455B filter

Centre frequency kHz	Bandwidth (-3dB) kHz	Loss dB (max.)
455 ± 2	4.5 ± 1	9

To obtain a reference against which various filter combinations may be compared it is necessary to define the filter shape factor in terms of two



meaningful and measurable bandwidths. For this filter, with skirts that are not particularly steep, the shape factor is defined as -30dB bandwidth divided by -3dB bandwidth. Coupling the two sections of the filter via a 68pF capacitor gave a shape factor of 6.35. Because the shape factor is a measure of attenuation for the unwanted sideband, it enables an assessment to be made of various filter configurations.

To improve skirt selectivity of the ceramic filter it is necessary to cascade sections with suitable coupling as shown in Fig. 1. The results of this are shown in Table 2. Six filter elements designated A to F were selected at random and measurements were made as detailed in the table. The centre frequency is $f_c = \sqrt{f(-3\text{dB})_{\text{upper}} \times f(-3\text{dB})_{\text{lower}}}$ and the bandwidth (measured 3dB down) is given by $BW = f(-3\text{dB})_{\text{upper}} - f(-3\text{dB})_{\text{lower}}$. Comparison between three cascaded filters all coupled by 56pF

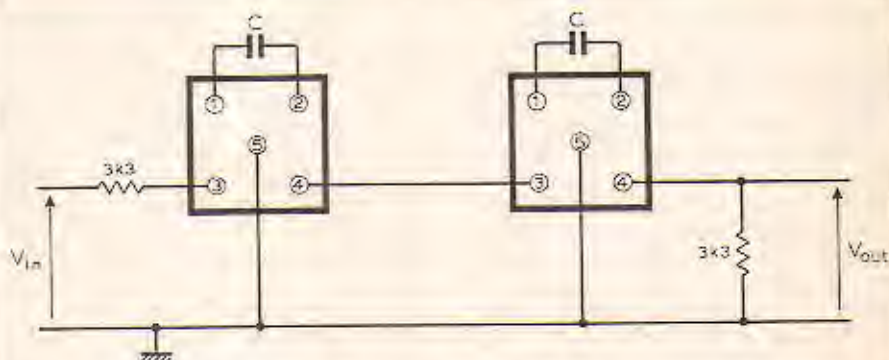

Fig. 1. Two cascaded 455kHz ceramic filters. This arrangement improves selectivity but increases the insertion loss.

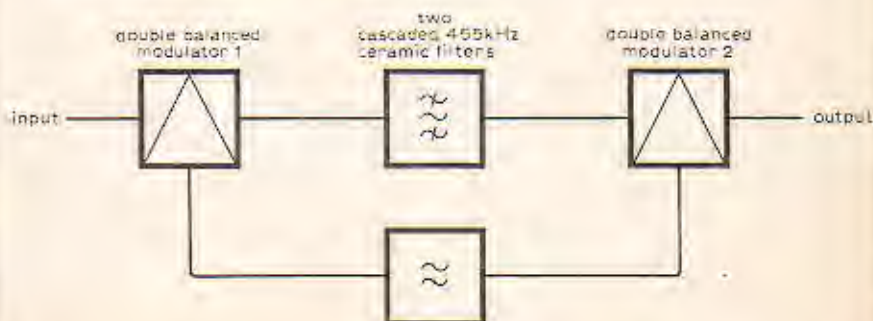
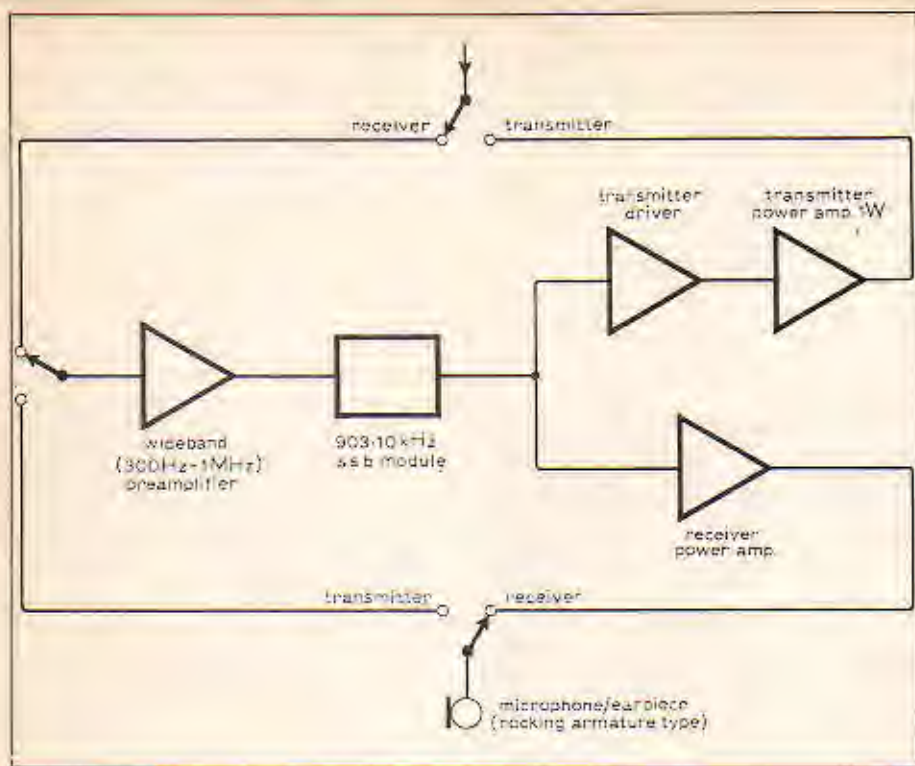

Fig. 2. 903.10kHz s.s.b. module. An oscillator frequency of 451.55kHz was found to provide optimum lower sideband suppression for 1kHz.



shows slight variation in bandwidth and insertion loss, both of which are within acceptable limits. Decreasing c to obtain a narrower bandwidth achieves this but at the expense of the filter shape factor which increases rapidly.

Transceiver

The system was designed to operate at $1\text{MHz} \pm 100\text{kHz}$. A block diagram is shown in Fig.3. A crystal oscillator frequency of 451.55kHz was found to produce optimum lower sideband suppression for 1kHz , and also gave acceptable performance when the 1kHz was replaced by speech, band-limited between 300Hz and 3kHz . Lower sideband attenuation is between 20 and 24dB at 1kHz in and varies either side of this frequency, decreasing as the 300Hz limit is approached. The signal at the output of the filter is upper sideband at 451.55kHz . This is mixed with 451.55kHz from the crystal oscillator in the second balanced modulator to produce u.s.b. at 903.10kHz and the original audio frequency components which are easily filtered out. The 903.10kHz signal is then linearly amplified in the following stages.

In the receive mode the incoming u.s.b. signal is fed through the system in the same direction. No switching of signal or oscillator lines is necessary in this generator-detector stage. To provide suitable signal routing around the s.s.b. module a multi-pole push-button switch was used which provided the push-to-talk facility. All circuitry was of standard design with Motorola MC1496 balanced modulators being used in the s.s.b. module. Because low power consumption is important in portable equipment these devices were used in preference to the Plessey SL640, which

Fig. 3. Block diagram of transceiver which uses standard units throughout.

dissipates approximately twice as much power.

A simple but effective s.s.b. transceiver was designed to fulfil a particular experimental role. This unit, though not generating high-quality s.s.b. has been proved capable of producing excellent results, and has shown that inexpensive ceramic filters have characteristics suitable for this type of application.

Table 2. Two SFD-455B filters in cascade

C	Centre frequency	Bandwidth	Loss	Shape factor	Sample
pF	kHz	kHz	dB		
56	455.60	3.94	18	2.54	A & B
56	455.20	3.90	11	2.47	C & D
66	455.41	4.20	12	2.50	E & F
47	455.61	3.67	12	2.65	E & F
33	455.87	3.14	11.5	3.84	E & F
22	456.42	1.87	13	4.05	E & F

Maximum stopband attenuation was around 40dB , which could be improved by cascading three or more filter sections at the expense of increased insertion loss. □

Vtr out in the cold

An American study says that the home video tape recorder industry will grow from $\$90$ million in 1976 to $\$318$ million in 1981. According to Steve Cottrell of Creative Strategies Inc. "Unlike others who have been very optimistic about potential consumer sales, our research indicates that substantial penetration of the home market is still years away." Bearing in mind that the market started from zero, a compound annual growth rate of 28% is rather less than might have been expected. Reasons include high prices and competition from other forms of entertainment. □

DMLS succeeds again

The list of successful trials of Plessey's Doppler microwave landing system (DMLS) now includes those carried out at Bern (Belp) airport. Landing systems currently in use are almost useless at Bern, which is surrounded by mountainous country and is said to offer the greatest challenge of any scenario so far investigated. In spite of the fact that the runway under test is only about one third the size of the average runway, 50 automatic landings were made and a further 50 tracked flights. More flying confirmed that the required coverage was obtained and a 30° offset was found to be practicable.

The next set of DMLS trials is scheduled for January at Tehran. □

The year's hi fi and other shows

Before current efforts to put some order into the annual hi-fi exhibition chaos have even begun, several show organisers have announced dates for the coming year. The first will take place at the Excelsior Hotel near Manchester Airport between January 19 and 22. There will, according to the organisers, be 40 exhibitors and lectures and film shows. On the first day the hours from 11 a.m. to 4 p.m. will be for the trade, and the show will be open to 9 p.m. on that and the next two days, closing at 7 p.m. on the Sunday.

From May 2 to 6 the Spring High Fidelity Exhibition will be held at the Cunard Hotel, Hammersmith, the last two days being open to the public.

The Harrogate autumn show will be at the exhibition complex instead of the local hotels as in previous years, from August 19 to 22, the first two days open to the public.

The Audio Fair at Olympia will be held between September 12 and 18.

The 59th AES convention goes to Hamburg between February 28 and March 3.

A three day seminar and exhibition on the use of microprocessors will take place at the West Centre Hotel, London, from February 8 sponsored by eight journals run by IPC Business Press, including *Wireless World*.

The All-electronics Show at Grosvenor House, Park Lane, London, is from February 14 to 16, and will be opened by Clive Sinclair, of pocket tv fame. Over 200 stands have been sold.

Another microprocessor show, this time organised by the IERE, will be held at the Old Swan Hotel, Harrogate, on April 11 and 12. The IERE is calling for papers.

At the Metropole Convention Centre, Brighton, the Electrical Research Association is holding a science and security conference between September 12 and 14. It will deal with the application of technology to preventing fire, flood, technical failure, burglary, theft and sabotage.

In 1979 there will be a seven day exhibition starting on September 20 alongside the World Administrative Radio Conference in Geneva. It will be the Third World Telecommunication Exhibition, sponsored by the Swiss Government. The Electronic Engineering Association would like to hear from any British firms wishing to participate in the exhibition as a joint venture.

In November, 1979, the first Electronics Components Industry Fair will be held at Olympia from the 20th to the 23rd, sponsored by the newly formed Electronic Components Industry Federation. This replaces the International London Electronic components Show (ILECS). □

NEW PRODUCTS

Absorption watt-meter

The TE-7 absorption wattmeter introduced by All-M Products Ltd is designed for radio use in the frequency range 1 to 500MHz. It houses a convection-cooled terminating load of 50Ω and allows continuous dissipation up to 15W and intermittent dissipation up to 25W. At 150MHz it has a s.w.r. of



WW301

better than 1.2:1. The unit uses a peak-reading detector and displays r.m.s. power in ranges of 0 to 5W and 2 to 25W. It has a BNC input connector but other types may be fitted. Provision exists for sampling the r.f. for use with frequency meters and in these cases it gives a signal attenuation of 33dB. The case is of robust metal construction and measures only 65 × 120 × 50mm. Price is £24.65. All-M Products Limited, 3 Westhill Close, Highworth, Swindon, Wiltshire, SN6 7BY. WW301

Distribution blocks

Rail-mounted terminals, in a range from Highland Electronics Limited, fit the DIN rail 46277/1 and are available in grey, brown or green/yellow colours. Half of the range comprises a 6mm pitch block with a 60A busbar, an 8mm block with a 102A busbar and a 10mm block with a 142A busbar. Cable sizes for these terminals are 4, 10 and 16mm² respectively. The rest of the range enables the user to connect onto one or two M8 studs with 1 by 70mm² or 2 by 70mm² cables with either 2, 4, 6 or 8 ways, each way to a maximum cable clamp facility of 16mm². An insulated cover,

which is supplied as standard, fits over the main cable stud and allows the cable to be connected in either direction. Highland Electronics Limited, Highland House, 8 Old Steine, Brighton, East Sussex BN1 1EJ. WW302

Impatt diode bias supplies

Constant-current power supplies, in a series from Avtech Electrosystems, are intended for biasing impatt-diode oscillator and amplifier circuits in low and medium power applications. The outputs from the Model AV-100 may be adjusted from 10 to 50mA for load voltages in the range 0 to 100V. Model AV-100P has an additional facility providing a pulsed output for pulsed-mode impatt diode operation. Model AV-101 is identical to the AV-100 except that it requires a direct input voltage of 15V, instead of a mains supply. These models, which all have meters and short-

circuit protection, measure 4.2 × 3 × 2.75in and weigh 1.5lb. Model AV-102 is a smaller, low-cost unit without a meter. It requires a direct input voltage of 115V but otherwise has similar specifications to the other models. The AV-102 measures only 2.25 × 1.38 × 1.13in and weighs only 0.5lb. Prices, without v.a.t. and duty, range from £67 to £198. Lyons Instruments Limited, Hoddesdon, Herts. WW303

Matched quad op-amps

The OP-09 quad operational amplifier, from Bourns (Trimpot) Ltd, has an input offset voltage of 500μV maximum and a c.m.r.r. of 100dB minimum. It also has a guaranteed matched c.m.r.r. of 94dB minimum and an input offset voltage match of 750μV maximum. The individual amplifiers in the OP-09 are claimed to be as reliable as the OP-02 op-amp, which is in com-

mon use. To optimise performance in active filter applications positive-going and negative-going slew rates are equal. Bourns (Trimpot) Limited, Holdford House, 17/27 High Street, Hounslow, Middlesex, TW3 1TE. WW304

Service tool set

A twenty-piece precision tool set, from Jonard Industries Corp., includes the major tools essential for the production, service and repair of electronic equipment.



WW305

The set includes three types of plier, four screw drivers, including a Philips type, two tweezers and two needle files. In addition there is a soldering iron and core, a magnifier, a burnisher, an alignment tool and two nut drivers. The complete set is contained in a leather case measuring eleven inches long by six inches wide. The case, including the tools, weighs only 2lb. Jonard Industries Corp., Precision Tools Division, 134 Marbledale Road, Tuckahoe, New York 10707, USA. WW305

Low-cost cermet trimmer

The Series 8035 cermet trimmer, from Greenwood Electronics, is a 3/4in-long rectangular, multi-turn device having a height of only 0.25in. Resistance values available range from 10Ω to 5MΩ with a resistance tolerance of ±10%. A fifteen-turn slider adjustment enables the trimmer to provide adjustment within ±0.05% of the



WW303



WW302

full scale. The 8035 is fully sealed and will withstand automated soldering and all known industrial cleaning solvents. Contact resistance is 1% maximum with a variation of less than 0.25%. The temperature coefficient of resistance is ± 100 for an operating range of -55 to $+125^\circ\text{C}$. At 25°C the trimmer has a power rating of 0.75W and its maximum input voltage is 300V. Price is 36p in large quantities. Greenwood Electronics Limited, Portman Road, Reading, Berks RG3 1NE. WW306

D.i.l. ceramic capacitors

Low-profile, multi-layer ceramic capacitors introduced by Sprague are available in 2-, 4-, 8-, 14- and



16-pin d.i.l. packages. The packages, registered as Multi-Comp Monolithic Ceramic Capacitors, permit closer stacking of p.c.b.s. Complete details are given in a document Engineering Bulletin No. 6242B which is available on request from Sprague Electric (UK) Limited, 159 High Street, Yiewsley, W. Drayton, Middlesex.

WW307

F.m. tuner head

The first f.m. varactor tuner head from a range to be introduced by Astec Europe Ltd is the UM1171. It is a compact, fully-shielded device intended for f.m. radio applications. The device will cover a frequency range from 88 to 108MHz by applying a tuning voltage of 2 to 20V. Main specifications are 12mA current consumption, 20dB power gain and a noise figure of 7dB maximum. The UM1171 measures only $20 \times 37 \times 71$ mm and may be provided with automatic frequency control. Astec Europe Limited, 4A Sheet Street, Windsor, Berks.

WW308

L.c.d. multimeter

Full-scale readings of 19999 on a liquid-crystal display, with a maximum error of 0.05% are provided by the Advance DMM9

multimeter, alternating and direct voltage and current from 10 μV and 10nA, resistance from 100m Ω and a separate range of 10a. The a-to-d converter is a true r.m.s. type which can cope with crest factors of 4 at full scale. Additional measurements are possible by the use of a temperature probe for use between -20°C and 120°C , a r.f. probe with detector and a 40kV probe. A printer interface provides a parallel b.c.d. output. Gould Advance Limited, Roebuck Road, Hainault, Essex. WW309

Paper tape reader

A portable, photoelectric paper-tape reader, available from Data Precision (Equipment) Ltd, has been designed to be used by service engineers for fault diagnosis. The unit, which is based on the recently announced DP203 tape reader, is capable of reading any known five, six or eight-track, punched-paper tapes, including typesetting and advanced sprocket types. Reading speeds are up to 250 characters per second and the feed is bidirectional. Plug-in c.m.o.s. i.c.s enable output changes to be made, and input changes are implemented by adding or removing soldered bars between p.c.b. tracks. The unit is ruggedly built and the infrared l.e.d.s and photosensors

are unaffected by ambient light. Data Precision (Equipment) Limited, 81 Goldsmith Road, Woking, Surrey. WW310

Close tolerance capacitors

A range of metallised-film polycarbonate capacitors, manufactured by Wingrove & Rogers Ltd, have capacitance value tolerances of $\pm 0.5\%$. Capacitor values down to 50pF are available in several axial and radial formats. The axial capacitors can be supplied with nylon or sleeved metal cases, sleeved metal cases with glass end seals, or in wrap and end sealed forms. The radial capacitors, which have nylon cases and are epoxy-resin filled, may be of the standard or low profile type. Polar Capacitors Limited, Domville Road, Liverpool L13 4AT.

WW311

Infrared illuminator

The Type RT5A infrared illuminator, from ITT Components, is capable of sharp focus and a very small minimum spot size. Its adjustable lens system allows a focus range giving "spot sizes" from a 0.2m line to a 1.2m diameter circle at 100m range



(N.B. for a sharp focus the "spot" is a line). At a small spot size, the maximum useful range is 1500m. The unit employs a pulsed, double-heterostructure laser and operates in the near infrared wavelength region of the frequency spectrum. Consequently its beam is virtually invisible. In night vision applications the RT5A may be used to illuminate areas which are shielded from natural light sources such as the stars or the moon. ITT Components Group Europe, Electron Device Product Group, Brixham Road, Paignton, Devon. WW312

Pocket cable stripper

The AB MK02 pocket tool, in addition to its prime function of stripping cables, can also be used for slitting cable insulations longitudinally. It has an adjustable cutting blade which can be set by turning a knurled screw to match the precise thickness of insulation to be stripped. The cable is retained by a spring-loaded clamp such that, by rotating the tool around the cable, the blade cuts through the insulation. The MK02 is suitable for round cable from 4.5 to 28.5mm in diameter. To slit the cable longitudinally the cutting blade is turned through 90° , by depressing a knob on the side of the tool, and the tool is pushed along the cable instead of around it. To assist in peeling off the more-difficult-to-remove insulations, a retracing ripping blade is housed in the handle. AB Engineering Co., Apem Works, St. Albans Road, Watford WD2 4AN. WW313

Static r.a.m.s

A range of n-channel, m.o.s. static r.a.m.s in plastic d.i.l. packages has been announced by NEC Electronics (Europe). The 22-pin $\mu\text{PD}2101$ is a 256-word by 4-bit device having an access time ranging from 450 to 250ns. The r.a.m., which is compatible with the Intel 2101 family, has a power dissipation of 220mW and requires a 5V power supply. The 16-pin $\mu\text{PD}2101$ is a 1K by 1-bit r.a.m. having the same access time range and supply require-



WW308



WW309

ment but its power dissipation is 150mW. This device is compatible with the Intel 2102AL family. The 18-pin μ PD2111 is also a 256-word by 4-bit device which is compatible with the Intel 2111 family. It has the same access time range and power requirements as the other devices but its power dissipation is typically 200mW. The 22-pin μ PD410 family is compatible with 22-pin dynamic r.a.ms and they have power requirements of +12V, +5V and -5V and power dissipations of 470mW. They have a storage capacity of 4K by 1-bit. NEC Electronics (Europe), 43 Civic Square, Motherwell, ML1 1TH, Scotland.

WW314

Dual-trace oscilloscope

The D12 oscilloscope, manufactured by Dartron Instruments Ltd, is a 17MHz instrument which operates automatically in the chopped or alternate sweep modes according to the sweep speed. The D12 has a sensitivity from 10mV/cm to 50V/cm or, with cascaded amplifiers, 1mV/cm with a bandwidth from 2Hz to 10MHz. The Y amplifier performance is up to 1MHz on both channels and these are calibrated from 10mV/cm to 50V/cm. Triggering is also available on both channels. The c.r.o. has a five-inch, helical post deflection accelerator and is used at an overall operating voltage of 3.6kV. ITT Instrument Services, Edinburgh Way, Harlow, Essex.

WW315

Photovoltaic cells

A family of silicon photovoltaic cells, introduced by National Semiconductors Ltd, comprises high-stability, high-efficiency de-



WW316



WW315



WW317

vices which, it is claimed, have excellent short-circuit current linearities over a wide range of illumination. Devices in the range have low leakage currents (10 μ A maximum when reverse biased by only 1.5V) and response rates of typically 8 μ s. The cells are normally of n-on-p construction, but reverse polarity p-n cells can be provided with a choice of either a low-capacitance, high-speed 800-type material or a 700-type material giving higher open-circuit voltages. National Semiconductors of Canada, Stamford House, Stamford New Road, Altrincham, Cheshire WA14 1DR.

WW316

D.i.l. switches for p.c.bs

The Boss (binary option selection switch) family of low-cost p.c.b. switches, from Molex Electronics Limited, has been designed for applications where manual programming of electronic equipment is required. When p.c.b.-mounted, ribs on the switch bases raise them from the board to allow flux residues to be removed. A double-lever design

enables the switch to make low-stress, high-force contacts. Brief electrical specifications include a switching rating at 30V d.c. (open circuit) of 50mA maximum, and a non-switching rating of 100mA r.m.s. at 50V d.c. maximum. Contact resistance, measured with a current flow of 10mA, is 100m Ω . Single-pole, double-throw and double-pole, single-throw versions are available. Molex Electronics Limited, 1 Holder Road, Aldershot, Hants GU12 4RH.

WW317

Heat-pipe power semiconductor

A range of power semiconductors known as "transcalent" devices has been introduced by RCA Electro-Optics & Devices, a division of RCA Solid State Europe. The devices have heat pipes bonded directly to large silicon wafers which are capable of handling currents up to at least 400A. These heat pipes minimize the thermal resistance and increase the radiator fin efficiency, thereby allowing the devices to be significantly smaller and lighter than conventional devices

having similar power ratings. Typically, size reduction is by a factor of four and weight reduction by a factor of seven. In addition the devices offer improved resistance against overloads and high-current surges. The first "transcalent" devices available from RCA are the P95000EB series of 250A, 500W rectifiers, which have blocking voltages up to 1200V, the P95400EB series of 400A, 500W thyristors, having blocking voltages up to 1200V, and the P95200EE4 100A, 500W n-p-n transistor. All of these devices can be supplied with radiator structures to accommodate air or liquid cooling. Thermal resistances are about 0.1 to 0.2°C/W and the operating ambient temperatures at full ratings range up to 50°C. RCA Limited, Solid State Europe, Sunbury-on-Thames, Middlesex TW16 7HW.

WW318

T.t.l. latch and flip-flop

Two devices just announced by Texas Instruments are a low-power Schottky t.t.l. latch and a flip-flop. The SN54LS/74LS373 comprises eight transparent D-type latches such that when its enable is high the Q outputs will follow its data inputs. When the enable is low the output will be latched at the level of the data (D) that was set up. The SN54LS/74LS374 has eight edge-triggered D-type flip-flops. On the positive transition of the clock, the Q outputs will be set to the logic states that were set up at the D inputs. Integrated Circuit Department, Texas Instruments Limited, Manton Lane, Bedford, MK41 7PA.

WW319

Closed-circuit tv tubes

Two camera tubes, Newvicon types XQ1276 and XQ1442 from Mullard, have high sensitivities and will enable closed-circuit tv cameras to work in dim twilight (1 lumen/metre²). Type XQ1276 has a spectral response in the near infrared region and a screen diameter of 2/3in. It is interchangeable with vidicons such as the XQ1271. The XQ1442 is fitted with a fibre-optic faceplate to enable high efficiency coupling to be achieved when the tube is used with a similarly coupled image intensifier. This tube is mechanically interchangeable with the Newvicon type XQ1440. Mullard Limited, Mullard House, Torrington Place, London WC1E 7HD.

WW320

A Jaguar in my boot

No, it's nothing to do with a tiger in the tank or even a nodding dog on the rear window ledge. The Jag, in question was a four-wheeled conveyance, not the motorway equivalent of a set of plaster ducks, and it was desperately trying to get into the boot of my car. It seemed like that, anyway, although since I was blinded by spray from the truck in front and blinded by the Jag's main beam headlights from behind I wouldn't want to swear to it. All I really wanted to do at that moment was to extend a pair of wings and get out of it.

There really ought to be some way of helping incompetents such as the aforementioned Jag driver to achieve their own, personal set of wings, accompanied by a harp, but since that approach is frowned upon by the Department of Environment somebody must come up with some kind of gadget to repel attack from the rear on wet, foggy days. And, since lunatics often harbour delusions to the effect that they are Napoleon, Albert Einstein or, worse, Stirling Moss, it is no good lighting up a lot of signs saying, "Careful" or even "Watch it, buster." At best they will think you guilty of *lèse majesté*, or, at worst, think it only applies to the other, bad, drivers.

As a matter of fact, you may be surprised to learn that I have already come up with the answer. There are any number of devices which tell you when there is ice or fog about (though I find I can usually see the fog for myself, thanks very much) but very little has been proposed to actually do anything about it when spotted. The only development to help in a case like this is the car-borne radar connected to the accelerator and brakes, so that if one approaches the car in front too closely and too fast, your anchors are automatically thrown overboard. Sounds fine, but it's not likely to be cheap and most drivers don't like their cars being taken over by machines.

As I said earlier, it isn't a bit of good just warning people. You can do that until you're blue in the face and still have maniacs charging about at 90 m.p.h. in dense fog. So what you've got to do is make it impossible. All you need is a fog and ice detector (photoelectric for fog — temperature and humidity for ice) and something to make the road surface come up like a lot of little mole-hills when you want to slow people down a bit. Inflatable tubes, like aircraft de-icers, would do the trick, but the details of how to make them and how to justify the cost I will have to leave to someone else. I can't be expected to do everything for the D.o.E.

What's in a name?

At an impressionable age, I watched the march of television northwards from Ally Pally, via Sutton Coldfield, to Holme Moss. From S.C., I was able to



receive a fairly poor picture (80 miles — 4-stage t.r.f.) but from H.M. the face of Leslie Mitchell was displayed in all its monochrome glory. I went to Holme Moss, which is really the name of a Pennine hill, not a transmitter, and gazed at this new monument to man's progress. There it stood, 750ft tall, on the top of a small mountain near Holmfirth. I could only see the top by lying on my back, a position which was mandatory anyway after pushing my bike up the road to the top.

The names given to these early transmitters were evocative of grandeur — Wenvoe, Pontop Pike, Rowridge, The Wrekin, Caradon Hill and so it remained until the smaller stations were built, with names like North Oldham and Halifax. But the final stage in the debasement of the image is now upon us. A Press Statement from Auntie Beeb last week informs us that a relay station at Wincobank in Sheffield is now on the air. What a sad decline! And how far from the ringing names of yesteryear. Would Kubla Khan have decreed his stately pleasure dome at Wapping Broadstairs or Penge? Of course not. And the screw is turned by the description of the service area which, we are told, encompasses not the plains of East Yorkshire or the mountains of Wales, but Standon Drive, Woodbury Road and Fife Street. If further proof of the BBC's possession of feet of clay is needed, the last sentence of the press release gives it: "The station is at Barrow Road, adjacent to the gasworks."

Remote control

In common with the majority of offices in the Smoke, and probably everywhere else in the country, we're in the middle of the annual rash of days off, on account of a number of variations on the theme of respiratory malfunction. Colds, even.

I've been so afflicted myself, albeit less drastically and for a shorter time than my more vulnerable colleagues, and while I was languishing there at home, pining for the office and supported only by the thought that they were able to go to the canteen for lunch,

while I had to content myself with rough, homely fare such as game soup, chicken and the kind of pudding people might commit murder for, it struck me (if I can remember what I was talking about at the start of this sentence) that the day of the commuter must nearly be over. Every dog has his day, so they say, and British Rail has nearly had its.

It's all so illogical. In a period when communication and easy access to computer terminals can be provided, it's a nonsense that all those thousands of official troglodytes should wear their individual little grooves deeper every day to get to the office, simply because the 'paperwork' is there, or because they have to attend a sales meeting. If eyeball-to-eyeball confrontation is essential, then a television method of some sort should suffice.

Think of the rates the big companies could save, too. Instead of a couple of million a year in Central London, a few thousand a year for the hire of the terminals and a suite at Claridge's for the M.D. — he's still got to have somewhere for the drinks cupboard and four walls for his Stubbs-surrogate horses.

Computers + 10⁻⁶?

It all depends on where you start from, I suppose. If the little ones had come first, they would now be called computers and the Swansea-type giants megacomputers. It seems rather a shame that, although "Micro" has a precise meaning in electronics, it is often used as a rather vague prefix meaning 'very small', which can change its meaning as time passes. A micro-computer of today could very well be classified as a minicomputer in a couple of years' time without anything about it being changed at all. "It's all a matter of relatives," as someone I know used to say, but then he has some very peculiar relatives indeed. (His Uncle Arthur has been known to eat coal — and he's the bright one.)

Where was I? Oh, yes — computers. Yes, well what I was coming to was the difference between processors and computers — a distinction which seems to become more blurred with every bit of paper that crosses my desk. I tend not to delay these bits of paper very long on their way across, but I have noticed as I pass them on to more technical colleagues that 'computer' seems to hold more attraction as a name than 'processor'. As I see it, a microprocessor can be the central processing unit of a microcomputer and, in the computing field, is incomplete without its programme memory, read/write memory, input/output buffers and latches, input keyboard or whatever and some kind of output display or recorder. Of course, it is usable without some of the peripheral equipment in the process control application, for which it was originally intended, but used in that way it is a controller, not a computer.



Model 178

Now . . . the next generation of bench DMMs!

Two New Keithley Models offer uncompromising performance and outstanding value!

- Accuracy 3 1/2's can't match: 0.4% + 1 digit on dc volts and ohms
- Large, bright, 20,000-count LED display that's quick and easy to read.
- Convenient bench size that won't get "lost" yet doesn't crowd.
- Exceptional reliability.

Model 178 offers functions and ranges for most measurement needs 100 μ V to 1200V dc, 100 μ V to 1000V ac, 0.1 Ω to 20M Ω .

Model 179 is a full-function, multi-feature model offering the same advantages as the 178. Plus

TRMS AC; 10 μ V Sensitivity; Hi and Lo Ohms; AC and DC Current Yet it's still half the price you'd expect. Only £199.

Both models feature designed-in reliability. Rugged circuits use a minimum of parts — high quality, off-the-shelf parts — carefully assembled and tested by Keithley. Outstanding overload protection and rugged mechanical design keep both units going even after severe abuse. One-year accuracy specifications minimise recalibration costs. A battery option, user installable, gets you off "line" for critical measurements or for field use.

For complete specifications on the 178 and 179, call Keithley Instruments, 1 Boulton Road, Reading. Phone 0734 861287

KEITHLEY
The measurement engineers.
WW-005 FOR FURTHER DETAILS

'Wenden' range modular amplifiers

A range of communications amplifiers having power ratings from 15 to 200 watts, plug-in input facilities ensure individual requirements can be provided.

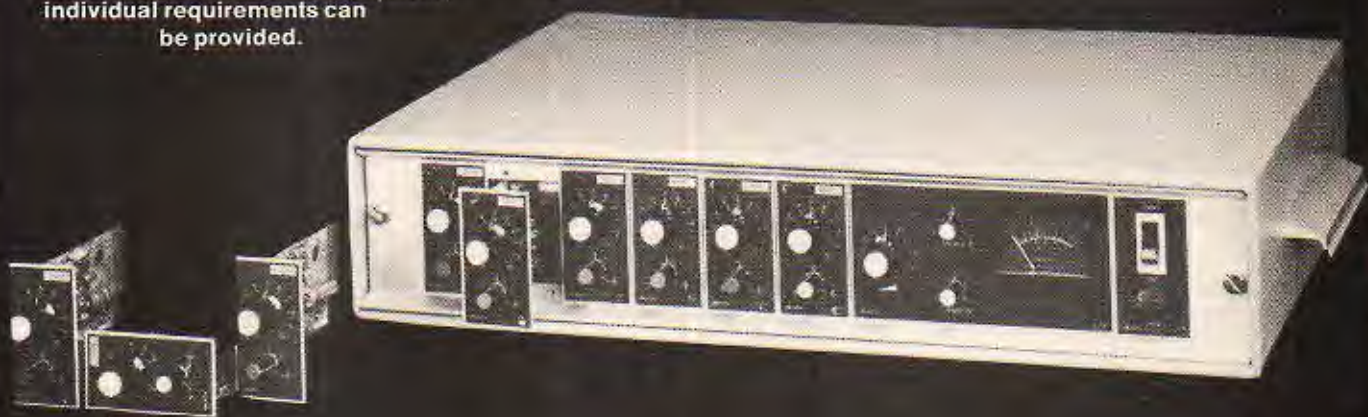

Manufacturers of
sound systems
and electronics

Station Road, Wenden
Saffron Walden
Essex CB11 4LG
Saffron Walden
(0799) 40888

audix

Communications 78

Communications Equipment and Systems



National Exhibition Centre, Birmingham, England.
Tuesday 4-Friday 7 April 1978

You are invited to Communications 78

Communications 78 is the world's leading exposition for selling communications equipment and systems, providing an international focal point for the latest technological advances in the fields of PTT telecommunications, fixed and mobile radio communications and defence communications.

Active backing

Trebled in size since the last event in 1976, Communications 78 is being supported by more than 200 international exhibitors and has the active backing of the International Telecommunication Union (ITU), representing the interests of 153 governments; the British government through the Ministry of Defence, the Home Office and the British Overseas Trade Board; Post Office Telecommunications; the Electronic Engineering Association (EEA) and the Telecommunication Engineering and Manufacturing Association (TEMA).

Integral conference

The integral conference is being organised by The Institution of Electrical Engineers (IEE) in association with the Institution of Electronic and Radio Engineers (IERE), the UKRI section of the Institute of Electrical and Electronics Engineers (IEEE) and the IEEE Communications Society.

Communications 78 is being held for the first time at the National Exhibition Centre, Birmingham—the UK's premier exhibition complex—from Tuesday 4 April to Friday 7 April 1978. The exhibition will be open daily from 09.30-18.00 hrs. (17.00 hrs. on last day).

Admission to the exhibition is free to bona fide users and specifiers of communications equipment and systems. The coupon below may be presented as an admission ticket to Communications 78 or, if you require more detailed information, please complete and send it to: Tony Davies Communications, c/o Industrial and Trade Fairs Ltd., Radcliffe House, Blenheim Court, Solihull, West Midlands B91 2BG, England.

Please send me details of

the exposition
the conference

Name _____

Position _____

Company _____

Address _____



40

MULTILAYER CERAMIC CAPACITORS

- ★ STYLES - Chips: 12 rectangular 4 discoidal - Radial Lead: 3 moulded 9 dipped - Axial Lead: 2 moulded 2 glass encased
- ★ DIELECTRICS - COG, X7R, Z5U
- ★ VOLTAGES - 200, 100, 50
- ★ APPROVALS - BS 9075 N023, N024, N025
BS 9075 F005, F022
- ★ ★ NEW CATALOGUE AVAILABLE
Send for your copy now

UK DISTRIBUTORS:
ITT Electronic Services: 0279 26777
Intel Electronics Ltd: 0462 812 505
Compstock: 0268 27722

ITT Components Group Europe

MULTILAYER CERAMICS DIVISION
South Denes, Great Yarmouth, Norfolk NR30 3PX.
Tel: 0493 56122. Telex: 97421. Cables: Resistor.

Components **ITT**

WW — 073 FOR FURTHER DETAILS

FREQUENCY COUNTERS

1/10 Hz to 1.2GHz

High performance instruments measuring frequency, period, time, freq./ratio and calibrated output facility. Fast delivery. Specials by arrangement.



TYPE 801B

CRYSTAL OVEN
OPERATING MANUAL
TWO-TONE BLUE CASE

£280 250 MHz

Sensitivity 10mV. Stability 5 parts 10.¹⁰

Resolution ± 1 Count

301M	32MHz 5 Digit £98	401A	32MHz 6 Digit £138
501	32MHz 8 Digit £192	701A	80MHz 8 Digit £210
801B/M	250MHz 8 Digit £280	901M	520MHz 8 Digit £385
		1001M	1.2GHz 8 Digit £670

Start/Stop versions plus £18

Memory versions available if not
suffixed M £30 extra

Type 101 1MHz 100KHz 10 KHz Crystal Standard £98
Type 103 Off/Air Standard £98

Type 203 Low Frequency Generator £78

SUPPLIERS TO: Ministry of Defence, G.P.O., B.B.C., Government Depts., Crystal
Manufacturers and Electronic Laboratories world-wide

RCS

R.C.S. ELECTRONICS
6 WOLSEY ROAD, ASHFORD
MIDDX. TW15 2RB
Telephone: Ashford (Code 69)
53661/2

WW—060 FOR FURTHER DETAILS

4 books from Wireless World

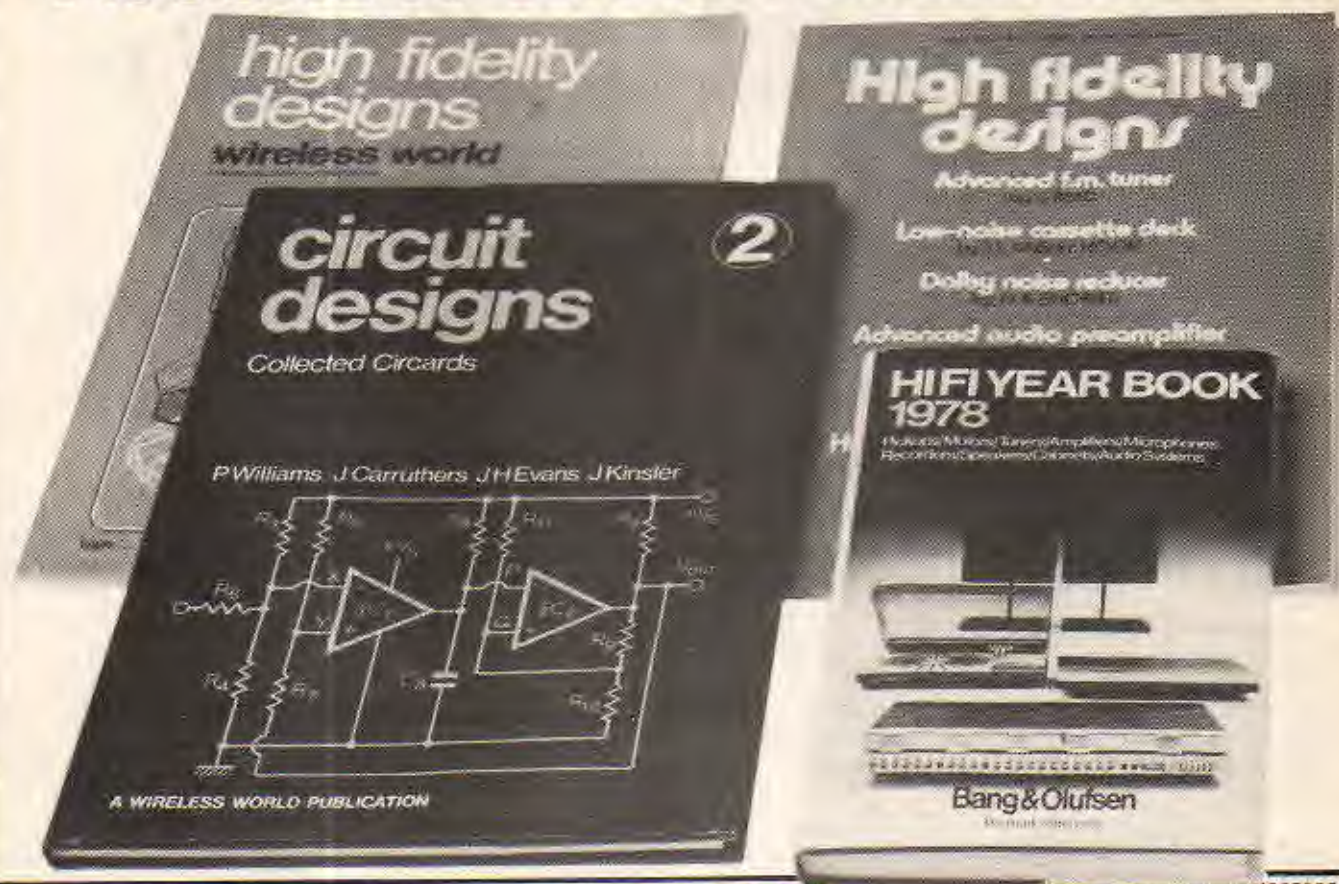

CIRCUIT DESIGNS-2 £12.50 inc.

The second collection of ten of Wireless World's highly successful Circards - previously published by the journal - giving selected circuits and other circuit data.

Includes:
Basic logic gates
Wideband amplifiers
Alarm circuits
Digital counters
Pulse modulators

C.d.as - signal processing
C.d.as - signal generation
C.d.as - measurement and detection
Monostable circuits
Transistors pairs

HI-FI YEAR BOOK 1978 £3.40 inc.

Your comprehensive guide to the major categories of hi-fi equipment, with pictures, descriptions, specifications, prices - everything you need to help you in your choice of equipment - backed by authoritative articles on choosing and using.

HIGH FIDELITY DESIGNS-1 £1.35 inc.

This book is the first collection of popular audio constructional articles formerly published in Wireless World. It covers the whole range of equipment, from signal sources to speakers and headphones, and from it can be selected a system suitable for most requirements.

Includes:
From Hacksaw to Haydn
High-quality tape recorder
Turntable construction
Pick-up arm construction
F.M. stereo tuner
Phase-locked stereo decoder
Bailey Burrows preamplifier
30-watt high fidelity amplifier
30-watt amplifier modification

Modular preamplifier design
Simple class A amplifier
New approach to class B amplifier design
A non-resonant loudspeaker enclosure
Low-cost high-quality loudspeaker design
Electrostatic headphone design
An i.c. peak programme meter

HIGH FIDELITY DESIGNS-2 £2.75 inc.

Published to meet the continued demand for reprints of Wireless World constructional projects, this book contains twenty five more of the 'most requested' articles which readers have asked for:
F.M. tuner design
Novel stereo fm. tuner
Low-noise, low-cost cassette deck
Wireless World Dolby noise reducer

Wideband compander design
High quality compressor/limiter
An automatic noise limiter
Modular integrated circuit audio mixer
The "walltenna"
Electronic piano design
Advanced preamplifier design
High quality tone control
Multi-channel tone control
Bailey Burrows preamplifier
30-watt high fidelity amplifier
30-watt amplifier modification

Baxandall tone control revisited
Active crossover networks
Electrostatic headphone amplifier
Class A power amplifier
An i.c. peak programme meter
Horn loudspeaker design
Horn loudspeaker
The transmission-line loudspeaker enclosure
Commercial quadraphonic systems

ORDER FORM

To: General Sales Department,
IPC Business Press Ltd.,
Room CP34, Dorset House,
Stamford Street, London SE1 9LU

Please send me publications
as indicated below:
(please state quantity)

- Circuit Designs-2**
@ £12.50 inc.
- Hi-Fi Year Book 1978**
@ £3.40 inc.
- High Fidelity Designs-1**
@ £1.35 inc.
- High Fidelity Designs-2**
@ £2.75 inc.

I enclose remittance
value £.....
(cheques payable to IPC
Business Press Ltd.).

NAME.....
(PLEASE PRINT)
ADDRESS.....

WW/7A/77

Company registered in England
No. 677128. Registered office:
Dorset House, Stamford Street,
London SE1 9LU.



S500-D

It is unique. Meet the new leader from H.H.

- * High Power capability, up to 500 watts per channel output.
- * Two channel stereo, or bridged output.
- * Superb audio performance, ultra low intermodulation and T.I.M. distortion.
- * Modular construction, integral force cooled dissipators (FCD).
- * High efficiency Toroidal Power Supply.
- * Compact size, only 3 1/2" high x 19" rack mounting.

Send for detailed information:
 H.H. ELECTRONIC,
 Viking Way, Bar Hill,
 Cambridge, CB3 8EL.
 Telephone: Crafts Hill (0954) 81140
 Telex: 817515 HH ELEC G

WW-093 FOR FURTHER DETAILS

How to generate confidence



G5
 £75.90
 inc. VAT
 and P&P.

M2B
 £71.00
 inc. VAT
 and P&P.

Produce instruments with a high specification at a low price — put them in steel cases for rugged reliability and guarantee the results. The G5 is a low distortion 10Hz to 1 MHz sine/square signal generator with a 600 ohm switched attenuator and a low impedance output of up to 3 watts.

Coupled with the M2B millivoltmeter, with its 1.2 mV full scale maximum sensitivity, you have the ideal test set. Calibrated in true RMS on the a.c. ranges it will measure up to 400 volts ac or dc and has a db range from -70 db to +54 db.

Send your Order now to Linstead Manufacturing Co. Ltd., Roslyn Road, London N15 5JB.

Linstead

Telephone: 01-802 5144

WW-071 FOR FURTHER DETAILS

HAVE YOU DONE IT LATELY!

Fit a new tape head and transform the performance of your tape recorder

MENLITH
 THE MONOLITH ELECTRONICS CO. LTD.

QUALITY
 REEL TO REEL
 AND CASSETTE TAPE HEADS



Full Catalogue 25p

Please enclose
 20p P&P with order

B24—RP stereo cassette glass/ferrite record/playback £9.84
 B12—01 mono cass. playbk. £1.60 B24—01 stereo cass. playbk. £2.80
 A28—05 stereo 8tk cartridge £1.80 E12—09 stereo/mono cass. erase £1.80

5/7 Church St, Crewkerne, Som. Tel. (0460) 74321

WW-063 FOR FURTHER DETAILS

Gas filled indicator tubes always available

character heights 8 -135 mm.

KGM ELECTRONICS LIMITED

Clock Tower Road, Isleworth,
 Middlesex TW7 6DU

Tel: 01-568 0151. Telex: 934120

WW-007 FOR FURTHER DETAILS



After the introduction of the CQ 110 E and CQ 301, NEC have completed their CQ-Line with the CQ 201 Digital VFO, the SP 110 Speaker and the M110 SSB Microphone. The NEC CQ-Line represents highest technical standard, with regard to design, quality, reliability and price which is available to the modern radio communicator today.

NEC CQ 110 E, 300 watts Digital transceiver Modes: FSK/USB/LSB/CW/AM, 100-240V AC/13.5DC handmike, Control speaker, VOX Sidetone, 3 Xtal filters, Blower, RCA 7360 RX Mixer, 22 fix-channels, 60 Page Manual, 160-10 meter, 11 Ranges of 500 KHz.

NEC CQ 301 2-3 KW SSB/AM Linear Amplifier 160-10 meter, 2 EIMAC 3-500Z, Handbook, 100-240 V AC, High Speed Blower, incorp. Power Supply.

NEC CQ 201 Digital Additional VFO for Split-Frequency Operation, containing 3 VFO systems, usable as frequency counter, 100-240 V AC/13.5VDC, Handbook.

NEC SP 110 Communication Speaker with Electronical Digital Clock, timer, etc. handbook 100-240 VAC.

NEC M 110 SSB Communications Microphone, designed for CQ — Line.

Colour of CQ line brown military sand-touch.

- ★ Dealer inquiries welcome
- ★ ASK ABOUT OUR UP TO 120 DAYS FINANCING FACILITIES
- ★ ASK FOR OUR COLOUR CATALOGUE against payment of SFR 16 — or any other equivalent currency.
- ★ Shipments to EVERYWHERE



Sole distributor in Europe:

CEC Corp., Via Valdani 1 — CH 6830 CHIASSO—SWITZERLAND
Phone: (091) 44 26 51. Telex: 79959 CH

WW-015 FOR FURTHER DETAILS

sales hire repair



We have been earning an enviable reputation as one of Britain's leading used equipment houses. Industrial, Research and Educational establishments, both large and small, have come to regard us as their first source of secondhand instrumentation at extremely competitive prices. With the ever increasing cost of equipment, it makes sound economic sense to take a long look at the advantages of either buying or hiring competitively priced used instrumentation from us.



MARTIN ASSOCIATES
34, Crown Street
Reading, Berks. RG1 2SE
Tele: Reading (0734) 51074

You'll do better at Martin Associates we guarantee it!

To support these activities we have a Repair & Calibration Laboratory who also provide a fast, keen priced service, with traceability to National Standard, for companies and individuals.

- TEKTRONIX** 491 Spectrum Analyser 10MHz - 40GHz **£3750.00**
- HEWLETT-PACKARD** 141T Spectrum Analyser 10MHz - 40GHz **£7500.00**
- HEWLETT-PACKARD** 8443A Tracking Generator **£1850.00**
- SOLATRON** A100 Dual Beam Oscilloscope DC - 30MHz **£350.00**
- MUIRHEAD** K134-A Wave Analyser 3Hz - 31.6KHz **£400.00**
- SOLARTRON** 7040 Multimeter with R.F. Probe & Case **£275.00**
- WAVETEK** 154 Programmable Waveform Generator 0.001Hz - 10MHz **£950.00**
- RADIOMETER** MS27g AM/FM Generator 0.3MHz - 240MHz **£550.00**
- CHEssel** 301 3 Pen full overlapping Recorder **£250.00**
- STATIM** 88 Hot/Cold Oven - 10°C to +70°C **£450.00**

*Hundreds
more items
in stock!*

For further information, complete & cut out the section below and post today.

NAME _____
POSITION _____
COMPANY _____
STREET _____
CITY _____ TELEPHONE READING (0734) 51074
FOR REPAIR & CALIBRATION TELEPHONE READING (0734) 51074

WIRELESS TIME :



approx. 3/4 full size digits shown here

National's MA1012 LED digital clock module is a complete clock & alarm unit, operating from 50 or 60 Hz mains, and offering all the features you would expect: Hours-minutes display in bright 0.5" leds with optional seconds, sleep and snooze alarms, fast and slow setting, AM/PM indicator, switched alarm outputs - but best of all *no RFI*. Thus the MA1012 is suitable for use in any radio/tuner applications, and requires just 1.75 x 3.75 x 0.7" total. (Ex. transformer), £9.45 per module, isolating mains transformer £1.50 each. (*8% vat) Two modules, and two transformers for £20.00 (+8% vat)

In the latest *Ambit* catalogue: more TOKO coils, chokes, filters etc., data on the short wave coil sets, a revised price list, micro-microphone inserts, special offer lines etc.

DETECKNOWLEDGEY

Metal locator principles and practise, including some of the facts and information manufacturers of £100+ detectors would rather you didn't know. £1.00 each.

The Bionic Ferret 4000 - a VCO metal locator based on the PW seekit, including all parts, plasticwork, ready wound coil etc. Inc. free copy of *detecknowledgey*. £34.26 in pp and VAT at 8%.

Special announcement: The Bionic Radiometer metal locator is at last to be released. A full VLF discriminator, with simultaneous display of ferrous, non-ferrous and foil objects. With a little practise, you can actually find objects obscured by junk. Outperforms units costing £150+. *Digital control*. Demo available at Brentwood, on sale soon for less than £75.SAE info:

COMPONENTS

Herewith the list of first quality parts and modules for wireless, inc. Europe's largest range of signal coils and inductors. 1/2m in stock!

CA3089E	FM IF	1.94	BC413	to noise	0.16	MFL 2.4 kHz isb mech.
KB4402	FM IF	1.94	40238	shld RF	0.25*	filter for ssp gen/IF 455kHz
HA1137W	FM IF	2.20	BF224	6ghz RF	0.22	with matching transfs. 9.95
TBA120	FM IF	0.75	BF274	7ghz RF	0.18	MFL series 4/5/7kHz band
TBA120S	FM IF	1.00	ZTX212	50v/3w	0.17	width 4/455kHz 1.95
sn78680n	FM IF	0.75	ZTX213	30v/3w	0.16	MFK series 7/9kHz bw 1.65
ua720	AM rad	1.40	ZTX214	30v/3w	0.17	Modules/tunerheads etc.
CA3123E	AM rad	1.40	ZTX451	60v/1w	0.18	EC3302 300v v/cap fm 7.50
HA1197	AM rad	1.40	ZTX551	60v/1w	0.18	EF5600 500v v/cap fm 12.98
TBA651	AM rad	1.81	8D515	45v/10w	0.27	EF5800 600v v/cap fm 15.25
MC1350	agg gain	1.00	8D516	45v/10w	0.27	EF5801 15800 (osc opt) 17.45
ue753	fm gain	1.80	8D535	80v/80w	0.52	8319 4 v/c, mos mixer 11.45
LM1496	bel mix	1.25	8D536	50v/80w	0.53	7252 complete fm mono
MC1310P	mpx dec	2.20	8D609	80v/90w	0.70	tunerset.afc,agg,mute 26.50
KB4400	as above	2.20	8D610	80v/90w	1.20	7253 complete fm stereo
ca3090a	mpx dec	4.35	BF256	1ghz fet	0.34	tunerset.afc,agg,mute 26.50
HA1199	mpx dec	4.20	E176	pc ch swt	0.38	7020 10.7MHz fm if 6.95
LM380	2w AF	1.00	MEM614	1408221	0.38*	7030 linear phase fm if 10.95
LM381	preamp	1.81	MEM616	1406731	0.87*	93090 ca3090a dec 8.36
tda2020	15w AF	2.99	MEM680	to noise	0.75*	92310 1310 decoder 6.95
tda940E	10w AF	1.80	BA102	vhl varic	0.30	91196 ha1196 decoder 12.99
tda810a	7w AF	1.06	BA121	vhl varic	0.30	91197 mw/lw v/cap tun11.35
LM301an	op amp	0.39*	BB104	dual var.	0.45	7122 3 v/c mw/lw (w) tuner
ua741	op amp	0.34*	BB105	vhl varic	0.40	K11 15v tuning 9.00
LM3900	op amp	0.88*	rvam2	dual AM	1.48	810k 7w af kit comp. £3
7805uc	5v/1amp	1.55*	rvam115	15v/AM	1.05	940k 10w af kit 3.95
tda1412	12v/1A	0.95*	rvam125	25v/AM	0.90	tda2020k pr. tda2020 ies,
78M20	20v/1A	1.20*				pcb, heatsinks for pa 9.35
78M24	24v/1A	1.20*				All mpx decoders feature
ue723cn	variable	0.80*				TOKO pilot tone filters.
NE550a	as above	0.80*				
taa550b	32v ref.	0.60*				
ic8038cc	sig gen	4.50*				
NE555v	timer	0.70*				
NE566v	vep	2.50*				
NE667v	tone dc	2.50*				
NE560B	ht pll	3.50*				
NE661B	ht pll	3.50*				
NE665K	ht pll	2.50*				
MC1312	quad	1.50				
11C90	650mhz	14.00*				
ZTX107	50v/3w	0.14				
ZTX108	30v/3w	0.14				
ZTX109	30v/3w	0.14				

TOKO Coils & Filters
 10mm & 7mm (rad cont)
 AM IFts with cap 0.30
 FM IFts with cap 0.33
 YHCS11098ACZ 0.30
 YHCS12374AC2 0.30
 YHCS11100AC2 0.30
 KALS4520A 0.33
 KACSK688HM 0.33
 LLC238 7mm 0.33
 LLC4827 7mm 0.33
 LLC4828 7mm 0.33
 CFS10.7 ceramic 0.90
 BLR3107N max 1.90
 BBR3132 5pole fm 2.25
 FX1115 beads 100.25
 MW/LW ferrite rod ant 0.90
 min. 10.1 trimmers (see pl)

VAT is extra at 12%, except where otherwise shown (*8%). PP now 25p per order. Catalogue 45p (inc). Pse send A5 or larger SAE with enquiries. Price lists free with an SAE. Full range of components etc available to callers at our new easy-to-get-to premises.

ambit INTERNATIONAL

Number 2, Gresham Road, Brentwood, Essex. CM14 4HN
 telephone (0277) 216029
 Our new premises are only 200 yards from Brentwood station - with parking facilities outside the door!!

WW—04H FOR FURTHER DETAILS

RADFORD HD250

High Definition Stereo Amplifier



A new standard for sound reproduction in the home! We believe that no other amplifier in the world can match the overall specification of the HD250.

Rated power output: 50 watts av. continuous per channel into any impedance from 4 to 8 ohms, both channels driven.

Maximum power output: 90 watts av. per channel into 5 ohms.

Distortion, preamplifier: Virtually zero (cannot be identified or measured as it is below inherent circuit noise.)

Distortion, power amplifier: Typically 0.006% at 25 watts, less than 0.02% at rated output (Typically 0.01% at 1 KHz)

Hum and noise: Disc.—83dBV measured flat with noise band width 23 KHz (ref 5mV); —88dBV "A" weighted (ref. 5mV)

Line —85 dBV measured flat (ref 100V)
 —88dBV "A" weighted (ref 100V)

Hear the HD250 at

SWIFT OF WILMSLOW

Dept. WW, 5 Swan Street, Wilmslow, Cheshire

(Tel: 26213)

Mail Order and Personal Expert enquiries: Wilmslow Audio, Swan Works, Bank Square, Wilmslow (Tel. 29599)

*Now available ZD100 power amplifier and ZD22 pre-amplifier

WW—04H FOR FURTHER DETAILS

TV GAMES IN FULL COLOUR

AV 3-8500 £5.95, AY-3
 8550 £9.95, AY-3-8600
 £13.95, 4 43 MHz crystal
 £1.95, Black and white TV
 games kit. Stereo model
 £11.95, Economy model
 £6.95, Colour TV games kit
 Stereo model £13.45, Economy model
 £14.45, Colour Generator kit adds colour to most
 black and white games £7.50, Rfs kit £4.95,
 Stereo set for grant, free data booklet

NEW COMPONENT SERVICE

Resistors 2% carbon £12.10 to 10M, 1/4W 1/2p,
 1W 3p. Preset pot. minimum 0.1W 100 to
 4M7 5p. Potentiometers 1W 4K7 to 2M2 log or
 1 ohm. Single 30p, dual 85p. Polystyrene
 capacitors 1.2 50v, 200pf to 8200pf 3 1/2p.
 Ceramic capacitors 50V 15 32pf to 4700pf
 3p. Mylar capacitors 100V 001, 002, 005mf
 4p, 01, 02, 025 4 1/2p. Polyester capacitors
 250V 50 pf to 1mf 5 1/2p, 15, 22, 33mf 7p,
 47mf 11p. Electrolytics 50V 47, 1, 2—15p,
 25V, 10mf 5p, 16V 22, 33, 47mf 6p, 100mf
 7p, 220, 330 5p, 470 11p, 1000mf 15p. Zener
 diodes 400mA 524 3v3 to 33V 8 1/2p.

MAINS TRANSFORMERS

50-0V 100-0A 84p, 300-0V 75-0A 84p, 120-
 12V 50mA 84p, 13V 75A £1.10,
 6 3/4 17V £1.88, 6 3/4 27V £2.38, 6 3/4 36V
 1A £1.99, 10-0 10V 1A £2.48, 15-0 15V 1A
 £2.79, 30-0 30V 1A £3.59, 24V 20A £1.99,
 90-0 2A £2.60.

PRINTED CIRCUIT MATERIALS

PC etching kits — economy £1.70, Standard
 £8.82, 50 square inch 40p, 1 lb FxCl £1.05, Etch
 resist paste Economy type 45p, Data type 85p.
 Small drill bit 20p, Laminite cutter 75p, Etching
 dish 85p.

S-DECS AND T-DECS+

S-DIC £2.23, T-DIC
 £3.98, addICA £3.97, U-
 DIC £8.87, 10 0V 500p
 tone — price 99p, 200
 tone £1.21, New S-decs
 £4.95.

SINCLAIR PRODUCTS

Cambridge Scientific programmable calculator
 £13.95, Prog. library £4.95, Maths appstar
 £3.20, Cambridge Scientific £8.45, Oxford
 Scientific £10.80, Enterprise £8.95, President
 £16.95, PRM35 digital multimeter £25.95,
 Astro £3.24.

BI-PAK AUDIO MODULES

5450 Tuner £21.95, AIGD £4.86, Pa100
 £14.95, SAKET audio kit £38.45, Stereo 3D
 £19.95, SPAN £3.75, SMTSD £9.95, Send for
 free data

JC12, JC20, JC40 AMPLIFIERS

A range of integrated circuit
 3-wire amplifiers supplied
 with free gets and printed
 circuits. £12 & 15 Watts
 £1.95, JC20 15 Watts
 £2.95, JC40 20 Watts
 £4.20.

Send for free data on all 3 models and full
 range of matching power supply and preamp kits

FERRANTI ZN414

10 1000 chip £1.44, 2400 parts and pots for tests
 £3.85, Case £1, Send see for details

BATTERY ELIMINATOR BARGAINS

TV games power unit standard 7 1/2V 100ma
 £2.25, 3-way models with switched output and
 4-way multi-tap — 3 1/4V/8V 100ma £2.92,
 6 1/2V/5V 150ma £3.30, 100ma radio models
 with press stud connections 9V £2.85, 6V £2.85,
 4.5V £2.85, 9V+9V £4.50, 6V+6V £4.50,
 4.5V+4.5V £4.50, Cassette recorder mains
 unit 2 1/2V 100ma with 6 pin dc plug £2.35,
 fully stabilized model switched output of
 3 1/2V 9V 400ma stabilising £6.40, Car
 converters 12V 60 ma in/out 500mA 9V 300ma
 £1.80, Output 70v 300ma £1.80.

BATTERY ELIMINATOR KITS

Send for free leaflet on ranges
 £100A radio types with press stud battery
 terminals 4.5V £1.80, 6V £1.80, 9V £1.80,
 4.5V+4.5V £2.50, 6V+6V £2.50, 9V+9V
 £2.50.

Cassette type 1W 100ma with dc plug £1.80.

Transistor stabilised 8-way type for low hum, 3
 1/2V 15 1/2V 2 1/2V 25 28 34 42V 1
 £2.20, 1 Amp model £6.40,
 Heavy duty 13-way types 4V, 6 1/2V, 8 1/2V,
 11 1/2V, 14V, 17V, 20V, 28V, 34V, 42V 1
 Amp £4.85, 2 Amp £7.95.

Car Converter kit, manual 12V DC, Output

6 1/2V 9V 25 1A transistor stabilised £1.85,
 Stabilised power kits 3 1/2V 100mA £3.60,
 3.30V 1A £9.95, 3 3/4V 1A £10.95, 3 3/4V 2A
 £13.95.

BULK BUY OFFERS

4 43MHz crystals — £24/25, 20 1/2 0.01 £11/50,
 NE555 timer 8 in £17.50/50, Data parts
 £16/25, 2 N3078 £15.50/50, 10 1/2 1 £16/
 50, 50 0V £7.00/100, BC105 £7.00/100,
 BC212 £8.00/100, 1N4002 £8.00/200,
 Bridge rectifiers — 1A 50Vrms £13.50/50,
 2A 50V rms £18.00/50, 2N414 £11.00/10,
 Electronics 2000m 40V £18.00/50, Sinefil
 £220 more power unit with 22V 1A £14.00/5.

CUT PRICE TELEKIT

Larger CM7028 relay to use, attractively etched
 components, which are all plugs straight into the
 serial socket of the set, giving full colour and
 requiring no modification to the TV Remote
 control page selection £323.
 Texas Instruments T174 Module for the
 operational 40+ channel mem £120.

SWANLEY ELECTRONICS

DEPT. WW, PO BOX 68, 32 GOLDSL RD., SWANLEY, KENT BR8 8TD

Mail order only. No delivery. Send for free data on kits, post and packing 30p. Prices include VAT. Other
 orders welcome. Overseas customers add 25% VAT on items marked * and 15% on others.

**SPECIAL CASH-N-CARRY SALE FOR YOUR 1978 BULK BUYING
— DON'T MISS OUT!!**

**SUPER
SALE BARGAINS**

TRANSISTORS

DEVICE	MANUFACTURER	PACK OF 10	PACK OF 100
AD161 / 162 M.P.P.	Tungstam	8.00	50.00
AF119	—	4.20	36.00
AF124	—	2.40	20.00
AF125	—	2.40	20.00
AF126	—	2.40	20.00
AF127	—	2.40	20.00
AF139	—	3.00	28.00
AF239	—	3.60	30.00

ALL PRICES EXCLUDE VAT

DEVICE	MANUFACTURER	PACK OF 10	PACK OF 100
BC107	MicroE	0.85	7.50
BC107A, B or C	MicroE	0.85	7.50
BC108	Tungstam	0.85	7.50
BC108A, B or C	MicroE	0.85	7.50
BC109	MicroE	0.85	7.50
BC109A, B or C	MicroE	0.85	7.50
BC139	S.G.S.	1.70	14.00
BC154	S.G.S.	0.80	6.50
BC179C	MicroE	1.20	9.00
BC182L	Carter	0.80	6.00
BC182LA, LB1	Carter	0.80	6.00
BC183L	Carter	0.80	6.00
BC183LA, LB1	Carter	0.80	6.00
BC184L	Texas	0.80	6.50
BC184L1	Texas	0.80	6.50
BC2371	Motorola	0.80	5.00
BC2381	Motorola	0.80	5.00
BC2569	MicroE	0.80	5.00
BC267	MicroE	0.80	8.00
BC303	MicroE	1.80	15.00
BC304	MicroE	1.80	15.00
BC309A	Telefunken	0.80	5.00
BC3201	Fairchild	0.80	5.00
BCV71	MicroE	1.10	9.00
BD135	Motorola	2.80	27.00
BD136	Motorola	2.80	27.00
BF179C	S.G.S.	1.90	15.00
BF190	Motorola	0.70	5.00
BF336	Mullard	2.00	19.00
BF337	Mullard	2.00	19.00
BF371	Motorola	1.00	8.00
BF394	Motorola	1.00	8.00
BFY50	MicroE	1.50	14.00
BSY25	Mullard	2.20	20.00
BT106	I.T.T. / A.E.I.	10.00	68.00
BTX94-400	Mullard	40.00	300.00
BTX94-600	Mullard	45.00	310.00
BY154	—	3.00	28.00

MINIMUM ORDER VALUE £5.00

DEVICE	MANUFACTURER	PACK OF 10	PACK OF 100
C1060	—	3.60	30.00
ME04131	MicroE	0.90	4.80
MJ2955	Motorola	8.00	75.00
MJE340	Hitechi	4.00	34.00
MJE2955	Motorola	8.00	73.00
MJE3055	Motorola	6.50	52.00
ORP12 / NSL4951	N.S.L.	5.50	45.00
OC28	Motorola	10.00	85.00
OC44	Mullard	4.80	30.00
OC71	—	4.00	25.00
TIP29A	T	3.20	25.00
TIP29B	T	3.60	30.00
TIP29C	T	4.30	35.00
TIP30	T	3.20	26.00
TIP30A	T	3.50	30.00
TIP30B	T	3.80	32.00
TIP31A	T	3.50	29.00
TIP31B	T	4.00	33.00
TIP33A	T	5.70	40.00
TIP33B	T	5.50	50.00
TIP34A	T	6.50	42.00
TIP41A	T	5.10	42.00
TIP41B	T	5.80	45.00
TIP120	T	5.40	40.00
TIP2955	T	4.80	45.00
TIP3055	T	4.00	39.00
2N1305	T	3.70	30.00
2N2646	Walbrunn	4.20	36.00
2N3806	—	1.50	13.00
2N2928V	—	1.20	9.00
2N3055A	Solidev	3.80	25.00
2N37041	Carter	0.80	6.00
2N3705	MicroE	0.80	5.00
2N3706	Carter	0.80	5.00
2N3711	Carter	0.70	5.00

ORDERING PROCEDURE
Strictly cash with order.
Minimum order value £5.00.
Post and Packing add 25p.
Prices subject to alteration without notice.

Our stocks comprise mainly of the brands stated. However we reserve the right to supply an alternative brand subject to availability, or to refund money if unable to supply.
Please allow 7 days for clearance of enquiries.

DIODES

DEVICE	MANUFACTURER	PACK OF 10	PACK OF 100
1AAY83	Transiron	7.00	50.00
1AAZ13	I.T.T.	7.00	50.00
1BAV20	Mullard	7.50	42.00
1BAX13	T.I.	3.00	25.00
1BAX16 / CV8790	T.I.	4.00	35.00
1BY288 series	Teleadyne / I.T.T.	6.50	50.00
1BZX81 series	Teleadyne / I.T.T.	11.00	90.00
7.5V-75V	—	4.70	40.00
10A10	—	7.00	55.00
10A47	Sesosem	4.00	35.00
10A80	Mullard	4.00	30.00
10A91	—	4.00	30.00
10A202 / CV8790	T.I.	4.00	35.00
11N914	—	5.00	30.00
11N4148	Mullard	2.00	15.00
11N4148 (50V)	I.T.T.	1.50	10.00
11N4001	Unitrade	3.00	25.00
11N4002	Unitrade	3.20	26.00
11N4003	Unitrade	3.40	27.00
11N4004	Unitrade	3.60	28.00
11N4005	Unitrade	3.80	29.00
11N4006	Unitrade	4.40	36.00
11N4818	Westinghouse	7.00	60.00
11N5393	Westinghouse	5.00	40.00
11N5395	Westinghouse	5.00	40.00
11N5401	MicroE	10.00	70.00

ALL PRICES EXCLUDE VAT

40A 50V DO5 STUD RECTIFIER

PACK OF 10	PACK OF 100
£7.00	50.00

TRIACS
PLASTIC TRIACS TO220 PACKAGE

DEVICE	MANUFACTURER	PACK OF 10	PACK OF 100
4A 200V	I.T.T.	4.00	30.00
4A 400V	I.T.T.	6.00	52.00
4A 600V	I.T.T.	7.00	60.00
6A 200V	I.T.T.	5.00	36.00
6A 400V	I.T.T.	6.50	58.00
6A 600V	I.T.T.	7.20	66.00
8A 200V	I.T.T.	6.00	40.00
8A 400V	I.T.T.	7.50	62.00
8A 600V	I.T.T.	8.50	70.00
10A 200V	I.T.T.	7.00	45.00
10A 400V	I.T.T.	8.00	66.00
10A 600V	I.T.T.	9.00	78.00

S.C.R.s

S.C.R.s TO5 METAL CAN

TYPE	VOLTAGE	PACK OF 10	PACK OF 100
1A	50V	4.50	30.00
1A	100V	5.50	40.00
1A	200V	6.50	50.00
1A	400V	7.00	60.00
1A	500V	8.00	70.00

SLIDER POTS!!!!

Slider pots (Noble) 15A 50K ohms.
Dimensions 8.7cm x 1.1cm x 1.1cm.
Fixing holes 8cm apart.

PACK OF 10	PACK OF 100
1.50	10.00

MOSTEK MOS 12-Digit Memory Calculator IC's.

FEATURES:

- 12 digit display with memory capability. Four operations (+, -, X, /) Automatic constant Floating decimal on entry and intermediate multiplication or division Fixed decimal on total results selectable to any position in the display. Memory overflow protection. Overflow indicator.
- Memory-in-use indicator Negative sign indicator for the credit balance. Chain calculations. Selectable truncate (or 5) 4 round-off Register exchange function. Leading Zero blanking Power-on clear capability 00 entry key. £2.50 + VAT

EXPORT ORDERS
Minimum order: £10.00
Post & Packing add £1.00

E.S.O.E.

VAT. Please add 8% to all prices except those marked, which are 12.5%.

MINIMUM ORDER VALUE £5.00
ALL PRICES EXCLUDE VAT
NO DISCOUNTS ON SALE PRICES

DIGITAL I.C.s

MANUFACTURER BRANDED FULL SPEC TTL INTEGRATED CIRCUITS MINIMUM 20+ MIX

Device	Price	Device	Price	Device	Price
7400	0.13	7441	0.70	7483	0.43
7401	0.14	7442	0.60	7484	0.70
7402	0.14	7445	1.10	7485	0.60
7403	0.14	7446	1.10	7486	0.70
7404	0.15	7447	0.87	74100	1.10
7405	0.15	7448	1.10	74110	0.38
7406	0.36	7475	0.46	74118	1.28
7407	0.36	7480	0.44	74119	1.14
7408	0.17	7481	0.84	74121	0.34
7409	0.17	7482	0.82	74122	0.48
7410	0.14	7483	0.80	74123	0.94
7411	0.15	7484	0.87	74141	0.21
7412	0.17	7485	0.87	74154	1.30
7413	0.26	7486	0.28	74180	0.83
7414	0.46	7489	2.40	74181	3.00
7416	0.26	7490	0.48	74180	1.40
7417	0.26	7491	0.70	74198	2.00
7440	0.17	7492	0.48	74199	1.80

CMOS
MINIMUM 20+ MIX

Device	Price	Device	Price	Device	Price
CD4000	0.17	CD4022	0.70	CD4046	1.10
CD4001	0.17	CD4023	0.17	CD4047	0.75
CD4002	0.17	CD4024	0.82	CD4049	0.47
CD4006	1.00	CD4025	0.17	CD4050	0.47
CD4007	0.17	CD4026	1.50	CD4054	1.16
CD4008	0.80	CD4027	0.48	CD4055	1.30
CD4009	0.55	CD4028	0.70	CD4056	1.30
CD4010	0.55	CD4029	1.00	CD4069	0.19
CD4011	0.17	CD4030	0.50	CD4070	0.34
CD4012	0.17	CD4031	2.05	CD4071	0.19
CD4013	0.46	CD4035	1.25	CD4072	0.19
CD4015	0.80	CD4037	1.05	CD4081	0.19
CD4018	0.43	CD4040	0.90	CD4082	0.19
CD4017	0.80	CD4041	0.60	CD4510	1.18
CD4018	0.80	CD4042	0.76	CD4511	1.30
CD4019	0.61	CD4043	0.80	CD4516	1.18
CD4020	0.90	CD4044	0.80	CD4518	0.94
CD4021	0.80	CD4045	1.25	CD4520	0.94

LINEARS

DEVICE	MANUFACTURER	PACK OF 10	PACK OF 100
LM380N 14-pin	National	6.50	60.00
LM309K T03	—	12.40	100.00
LM555 8-pin	National	3.20	28.00
LM709 14-pin	Raytheon	2.90	20.00
LM710 T099	Microsystems	4.10	38.00
LM723 T099	Microsystems	6.20	50.00
LM741 14-pin	Microsystems	1.00	8.00
LM741 8-pin	T.I.	2.50	20.00
MC1458 8-pin	Motorola	7.00	55.00
MC1802 8-pin	Motorola	4.50	35.00
LM3900 14-pin	National	6.50	50.00
18A120A	Siemens	4.00	35.00
TEA8731	Mullard	7.00	60.00
TEA8701	S.G.S.	8.00	75.00
TC4270SQ1	Mullard	7.50	50.00
TMS3409NC	T.I.	30.00	250.00
TMS4034N1	T.I.	20.00	180.00
76023N1	T.I.	12.50	100.00

L.E.D.s

LIGHT EMITTING DIODES
Red, Green and Yellow. Size .125" and .200"

Device	Price	Device	Price
125R	2.00R	1.40	12.00
125G	2.00G	2.00	18.00
—	2.00Y	2.00	18.00

Mounting clips .03 each
125 similar to 209 (small)
200 similar to 4850 (large)

SPRING '78 SALE OFFER

AMATEUR COMPONENTS

ORCHARD WORKS, CHURCH LANE, WALLINGTON, SURREY SM6 7NF

MAIL ORDER DIVISION OF SEM

AUDIO MODULES - ALL REDUCED! TRANSISTOR PRICES SLASHED! MANY PAKS 33% OFF

BI-PAK GREAT SPACE - WE NEED THE SPACE - SPECIAL OFFER!

THYRISTORS

No. THY1A/50	10amp	50 volt	T05	18p
No. THY1A/100	10amp	100 volt	T05	32p
No. THY3A/50	3Amp	50 volt	T06A	25p
No. THY3A/100	3Amp	100 volt	T06A	32p
No. THY3A/200	3Amp	200 volt	T06A	40p
No. THY5A/50	5Amp	50 volt	T05B	25p
No. THY5A/100	5Amp	100 volt	T05B	40p
No. THY5A/200	5Amp	200 volt	T05B	50p
No. C105/4	6Amp	400 volt	T0220	42p

TRIAC

58A 8Amp, 400 volt T0220 Plastic (Non Isolated Tab) 80p

DIACS

BR100 15p
BR2 15p

SWITCHES

No. 1517B 1 x Mini Slide Switch 40p
No. 517 5 x Miniature Slide Switches 40p
No. 518 4 x Standard Slide Switches 40p
No. 519 4 x Miniature Push to Make single pole mounting 40p
No. 520 2 x Miniature Push to Break single pole mounting 40p
No. 521 Push-button Switch Pak, 4 x Assorted types must be used singly. Listening and non-listening. £1.00

CAPACITOR PAKS

16701 18 Electrolytic 4.7µF 10V F 1.00p
16702 18 Electrolytic 10µF 100V F 1.00p
16703 18 Electrolytic 100µF 680V F 1.00p
ALL 3 AT Special Price of £1.20
15150 24 Ceramic Caps 22p/42p
15151 24 Ceramic Caps 100p/330p
15152 24 Ceramic Caps 4.7µF/3.30µF
15153 24 Ceramic Caps 4.7000µF 0.043µF
ALL 4 AT Special Price of £1.60

RESISTOR PAKS

Order No. 16213 50 1/4W 100 ohm-820 ohm
16214 50 1/4W 1K-8.2K
16215 50 1/4W 10K-82K
16216 50 1/4W 100K-820K
ALL 4 AT Special Price of £1.60
16217 40 1/2W 100 ohm-820 ohm
16218 40 1/2W 1K-8.2K
16219 40 1/2W 10K-82K
16220 40 1/2W 100K-820K
ALL 4 AT Special Price of £1.60

TRANSISTOR FALL-OUT PACK GERM, SILOCON, POWER, NPN, PNP ALL MIXED, YOURS TO SORT AND TEST

Approx. 500 pieces
Order No. S23 £1.25 per pack

VOLTAGE REGULATORS

Positive
No. MVR7805 ±47805 T0220 85p
No. MVR7812 ±47812 T0220 85p
No. MVR7815 ±47815 T0220 85p
No. MVR7818 ±47818 T0220 85p
No. MVR7824 ±47824 T0220 85p

Negative
No. MVR7905 ±47905 T0220 £1.10
No. MVR7912 ±47912 T0220 £1.10
No. MVR7915 ±47915 T0220 £1.10
No. MVR7918 ±47918 T0220 £1.10
No. MVR7924 ±47924 T0220 £1.10

±4723C T099 38p 7223 14 pin DIL 38p
1M909K T03 £1.20

MICROPHONES

DYNAMIC DUAL IMPEDANCE UNI-DIRECTIONAL CARDIOID MICROPHONE
Impedance 600ohms and 50K Response 50-14,000 Hz
Sensitivity 34dB @ 50K Size 1 1/2" Dia x 1 1/2" Long
Order No. 1326 £1.50

DYNAMIC CASSETTE MIC

Fitted with Car-Dell switch, 1 metre of tough lead with 3.5mm 2.5 and 3.5mm plugs
Impedance 200 ohms Sensitivity 80dB Frequency 50-10,000 Hz Size 20mm Diameter x 12mm Long
Order No. 1326 £1.15

LOGIC PROBE

A pocket size instrument capable of detecting TTL, DTL, TTL and other pulse circuits. It is easy to use and operates from the 5V D.C. supply of the circuit under test. The logic levels are indicated by 2 red LEDs one for HIGH and the other for LOW. There is also a green LED for the Pulse Mode of the unit.
No. 559 Our Special Price £15.95

TRANSISTORS

BRAND NEW - FULLY GUARANTEED

Type	Price	Type	Price	Type	Price	Type	Price
AC103	25p	BC177	12p	BF194	9p	2N1893	28p
AC126	14p	BC179	12p	BF195	9p	2N2218	28p
AC127	16p	BC182	9p	BF197	12p	2N2219A	15p
AC128	16p	BC184	9p	BF200	25p	2N2221A	15p
AC128K	24p	BC184	9p	BF201	12p	2N2222A	15p
AC178	16p	BC184	9p	BF202	12p	2N2222B	15p
AC178A	24p	BC184	9p	BF203	12p	2N2222C	15p
AC180	16p	BC184	9p	BF204	12p	2N2222D	15p
AC180K	24p	BC184	9p	BF205	12p	2N2222E	15p
AD101	10p	BC184	9p	BF206	12p	2N2222F	15p
1G2MP	30p	BC184	9p	BF207	12p	2N2222G	15p
AF139	30p	BC184	9p	BF208	12p	2N2222H	15p
AF239	30p	BC184	9p	BF209	12p	2N2222I	15p
BC107	6p	BC184	9p	BF210	12p	2N2222J	15p
BC108	6p	BC184	9p	BF211	12p	2N2222K	15p
BC109	6p	BC184	9p	BF212	12p	2N2222L	15p
BC110	6p	BC184	9p	BF213	12p	2N2222M	15p
BC111	6p	BC184	9p	BF214	12p	2N2222N	15p
BC112	6p	BC184	9p	BF215	12p	2N2222P	15p
BC113	6p	BC184	9p	BF216	12p	2N2222Q	15p
BC114	6p	BC184	9p	BF217	12p	2N2222R	15p
BC115	6p	BC184	9p	BF218	12p	2N2222S	15p
BC116	6p	BC184	9p	BF219	12p	2N2222T	15p
BC117	6p	BC184	9p	BF220	12p	2N2222U	15p
BC118	6p	BC184	9p	BF221	12p	2N2222V	15p
BC119	6p	BC184	9p	BF222	12p	2N2222W	15p
BC120	6p	BC184	9p	BF223	12p	2N2222X	15p
BC121	6p	BC184	9p	BF224	12p	2N2222Y	15p
BC122	6p	BC184	9p	BF225	12p	2N2222Z	15p
BC123	6p	BC184	9p	BF226	12p	2N2222AA	15p
BC124	6p	BC184	9p	BF227	12p	2N2222AB	15p
BC125	6p	BC184	9p	BF228	12p	2N2222AC	15p
BC126	6p	BC184	9p	BF229	12p	2N2222AD	15p
BC127	6p	BC184	9p	BF230	12p	2N2222AE	15p
BC128	6p	BC184	9p	BF231	12p	2N2222AF	15p
BC129	6p	BC184	9p	BF232	12p	2N2222AG	15p
BC130	6p	BC184	9p	BF233	12p	2N2222AH	15p
BC131	6p	BC184	9p	BF234	12p	2N2222AI	15p
BC132	6p	BC184	9p	BF235	12p	2N2222AJ	15p
BC133	6p	BC184	9p	BF236	12p	2N2222AK	15p
BC134	6p	BC184	9p	BF237	12p	2N2222AL	15p
BC135	6p	BC184	9p	BF238	12p	2N2222AM	15p
BC136	6p	BC184	9p	BF239	12p	2N2222AN	15p
BC137	6p	BC184	9p	BF240	12p	2N2222AO	15p
BC138	6p	BC184	9p	BF241	12p	2N2222AP	15p
BC139	6p	BC184	9p	BF242	12p	2N2222AQ	15p
BC140	6p	BC184	9p	BF243	12p	2N2222AR	15p
BC141	6p	BC184	9p	BF244	12p	2N2222AS	15p
BC142	6p	BC184	9p	BF245	12p	2N2222AT	15p
BC143	6p	BC184	9p	BF246	12p	2N2222AU	15p
BC144	6p	BC184	9p	BF247	12p	2N2222AV	15p
BC145	6p	BC184	9p	BF248	12p	2N2222AW	15p
BC146	6p	BC184	9p	BF249	12p	2N2222AX	15p
BC147	6p	BC184	9p	BF250	12p	2N2222AY	15p
BC148	6p	BC184	9p	BF251	12p	2N2222AZ	15p
BC149	6p	BC184	9p	BF252	12p	2N2222BA	15p
BC150	6p	BC184	9p	BF253	12p	2N2222BB	15p
BC151	6p	BC184	9p	BF254	12p	2N2222BC	15p
BC152	6p	BC184	9p	BF255	12p	2N2222BD	15p
BC153	6p	BC184	9p	BF256	12p	2N2222BE	15p
BC154	6p	BC184	9p	BF257	12p	2N2222BF	15p
BC155	6p	BC184	9p	BF258	12p	2N2222BG	15p
BC156	6p	BC184	9p	BF259	12p	2N2222BH	15p
BC157	6p	BC184	9p	BF260	12p	2N2222BI	15p
BC158	6p	BC184	9p	BF261	12p	2N2222BJ	15p
BC159	6p	BC184	9p	BF262	12p	2N2222BK	15p
BC160	6p	BC184	9p	BF263	12p	2N2222BL	15p
BC161	6p	BC184	9p	BF264	12p	2N2222BM	15p
BC162	6p	BC184	9p	BF265	12p	2N2222BN	15p
BC163	6p	BC184	9p	BF266	12p	2N2222BO	15p
BC164	6p	BC184	9p	BF267	12p	2N2222BP	15p
BC165	6p	BC184	9p	BF268	12p	2N2222BQ	15p
BC166	6p	BC184	9p	BF269	12p	2N2222BR	15p
BC167	6p	BC184	9p	BF270	12p	2N2222BS	15p
BC168	6p	BC184	9p	BF271	12p	2N2222BT	15p
BC169	6p	BC184	9p	BF272	12p	2N2222BU	15p
BC170	6p	BC184	9p	BF273	12p	2N2222BV	15p
BC171	6p	BC184	9p	BF274	12p	2N2222BW	15p
BC172	6p	BC184	9p	BF275	12p	2N2222BX	15p
BC173	6p	BC184	9p	BF276	12p	2N2222BY	15p
BC174	6p	BC184	9p	BF277	12p	2N2222BZ	15p
BC175	6p	BC184	9p	BF278	12p	2N2222CA	15p
BC176	6p	BC184	9p	BF279	12p	2N2222CB	15p
BC177	6p	BC184	9p	BF280	12p	2N2222CC	15p
BC178	6p	BC184	9p	BF281	12p	2N2222CD	15p
BC179	6p	BC184	9p	BF282	12p	2N2222CE	15p
BC180	6p	BC184	9p	BF283	12p	2N2222CF	15p
BC181	6p	BC184	9p	BF284	12p	2N2222CG	15p
BC182	6p	BC184	9p	BF285	12p	2N2222CH	15p
BC183	6p	BC184	9p	BF286	12p	2N2222CI	15p
BC184	6p	BC184	9p	BF287	12p	2N2222CJ	15p
BC185	6p	BC184	9p	BF288	12p	2N2222CK	15p
BC186	6p	BC184	9p	BF289	12p	2N2222CL	15p
BC187	6p	BC184	9p	BF290	12p	2N2222CM	15p
BC188	6p	BC184	9p	BF291	12p	2N2222CN	15p
BC189	6p	BC184	9p	BF292	12p	2N2222CO	15p
BC190	6p	BC184	9p	BF293	12p	2N2222CP	15p
BC191	6p	BC184	9p	BF294	12p	2N2222CQ	15p
BC192	6p	BC184	9p	BF295	12p	2N2222CR	15p
BC193	6p	BC184	9p	BF296	12p	2N2222CS	15p
BC194	6p	BC184	9p	BF297	12p	2N2222CT	15p
BC195	6p	BC184	9p	BF298	12p	2N2222CU	15p
BC196	6p	BC184	9p	BF299	12p	2N2222CV	15p
BC197	6p	BC184	9p	BF300	12p	2N2222CW	15p
BC198	6p	BC184	9p	BF301	12p	2N2222CX	15p
BC199	6p	BC184	9p	BF302	12p	2N2222CY	15p
BC200	6p	BC184	9p	BF303	12p	2N2222CZ	15p
BC201	6p	BC184	9p	BF304	12p	2N2222DA	15p
BC202	6p	BC184	9p	BF305	12p	2N2222DB	15p
BC203	6p	BC184	9p	BF306	12p	2N2222DC	15p
BC204	6p	BC184	9p	BF307	12p	2N2222DD	15p
BC205	6p	BC184	9p	BF308	12p	2N2222DE	15p
BC206	6p	BC184	9p	BF309	12p	2N2222DF	15p
BC207	6p	BC184	9p	BF310	12p	2N2222DG	15p
BC208	6p	BC184	9p	BF311	12p	2N2222DH	15p
BC209	6p	BC184	9p	BF312	12p	2N2222DI	15p
BC210	6p	BC184	9p	BF313	12p	2N2222DJ	15p
BC211	6p	BC184	9p	BF314	12p	2N2222DK	15p
BC212	6p	BC184	9p	BF315	12p	2N2222DL	15p
BC213	6p	BC184	9p	BF316	12p	2N2222DM	15p
BC214	6p	BC184	9p	BF317	12p	2N2222DN	15p
BC215	6p	BC184	9p	BF318	12p	2N2222DO	15p
BC216	6p	BC184	9p	BF319	12p	2N2222DP	15p
BC217	6p	BC184	9p	BF320	12p	2N2222DQ	15p
BC218	6p	BC184	9p	BF321	12p	2N2222DR	15p
BC219	6p	BC184	9p	BF322	12p	2N2222DS	15p
BC220	6p	BC184	9p	BF323	12p	2N2222DT	15p
BC221	6p	BC184	9p	BF324	12p	2N2222DU	15p
BC222	6p	BC184	9p	BF325	12p	2N2222DV	15p
BC223	6p	BC184	9p	BF326	12p	2N2222DW	15p
BC224	6p	BC184	9p	BF327	12p	2N2222DX	15p
BC225	6p	BC184	9p	BF328	12p	2N2222DY	15p
BC226							

SAVING SALE

YOU MAKE THE SAVING!

BI-PAK

OPT FOR OPTOELECTRONICS! PRINTED CIRCUIT KITS, BOARDS & PENS.

POTENTIOMETERS

Slider 40 MM. Travel

Order No.	Value	Order No.	Value
16191	6 x 470 Ohm LIN Single	40p*	
324	6 x 1K LIN Single	40p*	
325	6 x 5K LIN Single	40p*	
16192	6 x 10K LIN Single	40p*	
326	6 x 10K LOG Single	40p*	
16193	6 x 22K LIN Single	40p*	
16195	6 x 47K LOG Single	40p*	
16194	6 x 47K LIN Single	40p*	
327	6 x 100K LIN Single	40p*	
328	6 x 100K LOG Single	40p*	
329	6 x 500K LOG Single	40p*	

Slider 60 mm. Travel

Order No.	Value	Order No.	Value
330	6 x 2.2K LOG Single	40p*	
331	6 x 10K LIN Single	40p*	
332	6 x 50K LIN Single	40p*	
333	6 x 250K LOG Single	40p*	
334	6 x 1K LOG Dual	40p*	
335	4 x 10K LIN Dual	40p*	
336	4 x 100K LOG Dual	40p*	
337	4 x 1.3 MEG LOG Dual	40p*	

S38 MIXER SLIDER POTS. VARIOUS VALUES & SIZES OUR MIX £1.00*

S39 6 x CHROME SLIDER KNOBS £1.00*

WIREWOUND

Range of wirewound single gang pots, with linear tracks of 1-watt rating.

Order No.	Value	Order No.	Value
1891	10 ohms	1896	470 ohms
1893	47 ohms	1897	1K
1894	100 ohms	1898	2K2
1895	220 ohms	1899	4K7

NOW ONLY 35p Each

15 Rotary Potentiometers Assorted values and types 40p*

16186 25 Pre-sets Assorted Values and types 40p*

SALE PRICE 40p

MULTI-TURN PRE-SETS

S40 3 x 100K LIN ONLY 50p

AUDIO PLUG AND SOCKET PAKS

Order No.	Description	Price
S1	5 x 3.5mm Plastic Jack Plugs	40p*
S2	5 x 2.5mm Plastic Jack Plugs	40p*
S3	4 x Std. Plastic Jack Plugs	50p*
S4	2 x Stereo Jack Plugs	30p*
S5	5 x 5-pin 180° Din Plugs	50p*
S6	8 x 2-pin Loudspeaker Plugs	50p*
S7	6 x Phone Plugs Plastic	50p*
S8	5 x 3.5mm Chassis Sockets (Switched)	25p*
S9	5 x 2.5mm Chassis Sockets (Switched)	25p*
S10	4 x Metal Std. Chassis Switched Jack Sockets	50p*
S11	2 x Stereo Jack Sockets with instruction leaflet for Headphone connection	50p*
S12	5 x 5-pin 180° Din Chassis Sockets	40p*
S13	8 x 2-pin Din Chassis Sockets	50p*
S14	6 x Single Phone Sockets	40p*

AUDIO LEADS

Order No.	Description	Price
117	A.C. Mains connecting lead for cassette recorders and radios. Telefunken type	45p*
118	5-pin Din Headphone Plug to stereo socket	78p*
119	2 x 2-pin Plug to inline stereo socket for headphones	60p*
123	20ft. of coiled guitar lead	£1.15*
124	3-pin to 3-pin Din Plug	50p*
125	Audio Lead 5-pin Plug to 5-pin Din Plug	50p*
126	Audio Lead 5-pin Din plug to tinned open ends	50p*
127	Audio Lead 5-pin Din plug to 4 phone plugs	90p*
129	Audio Lead 5-pin Plug to 5-pin Din Plug — mirror image	70p*
130	5 Meter Lead 2-pin Din plug to 2-pin Din inline socket	45p*
132	10 Meter Lead 2-pin Din plug	85p*

HEAVY GAUGE BLACK PLASTIC BOX

With aluminium lid and fixing screws
Size: 6 1/4" x 3 3/4" x 2"
Order No. S16 Only 75p

74 SERIES TTL ICs

TYPE	QUANTITY		TYPE	QUANTITY		TYPE	QUANTITY	
	1	100		1	100		1	100
7400	0.08	0.08	7448	0.70	0.68	7422	0.46	0.42
7401	0.11	0.10	7450	0.12	0.10	7423	0.65	0.62
7402	0.11	0.10	7451	0.12	0.10	7424	0.68	0.65
7403	0.11	0.10	7452	0.12	0.10	7425	0.75	0.72
7404	0.11	0.10	7454	0.12	0.10	7426	1.10	1.05
7405	0.11	0.10	7455	0.12	0.10	7427	0.65	0.60
7406	0.28	0.25	7470	0.24	0.23	7453	0.70	0.68
7407	0.28	0.25	7472	0.20	0.18	7454	1.20	1.10
7408	0.12	0.11	7473	0.28	0.22	7455	0.70	0.68
7409	0.12	0.11	7474	0.24	0.23	7456	0.70	0.68
7410	0.09	0.08	7475	0.44	0.40	7457	0.70	0.68
7411	0.22	0.20	7476	0.28	0.25	7458	0.85	0.85
7412	0.22	0.20	7480	0.48	0.42	7459	0.85	0.85
7413	0.26	0.25	7481	0.90	0.88	7460	0.95	0.85
7414	0.28	0.25	7482	0.75	0.72	7461	0.95	0.85
7415	0.26	0.25	7483	0.85	0.82	7462	1.20	1.10
7416	0.28	0.25	7484	0.85	0.80	7463	1.20	1.10
7417	0.19	0.18	7485	1.10	1.00	7464	1.20	1.10
7418	0.21	0.20	7486	0.28	0.28	7465	1.10	1.00
7419	0.25	0.23	7487	2.70	2.50	7466	0.85	0.82
7420	0.25	0.23	7490	0.38	0.32	7467	1.40	1.00
7421	0.26	0.23	7491	0.85	0.82	7468	1.10	1.00
7422	0.36	0.34	7492	0.43	0.39	7469	1.40	1.00
7423	0.12	0.10	7493	0.38	0.35	7470	1.40	1.00
7424	0.20	0.19	7494	0.70	0.68	7471	0.80	0.78
7425	0.38	0.36	7495	0.80	0.88	7472	1.50	1.40
7426	0.26	0.25	7496	0.70	0.68	7473	1.40	1.30
7427	0.26	0.25	7497	0.95	0.90	7474	1.40	1.30
7428	0.12	0.10	7498	0.40	0.35	7475	1.10	1.00
7429	0.60	0.57	7499	0.30	0.25	7476	1.05	1.00
7430	0.80	0.70	7500	0.30	0.25	7477	1.05	1.00
7431	0.95	0.90	7501	0.48	0.45	7478	1.40	1.30
7432	0.85	0.80	7511	0.76	0.72	7479	0.80	0.85
7433	0.80	0.75	7512	0.85	0.82	7480	0.90	0.85
7434	0.80	0.75	7513	1.30	1.20	7481	1.30	1.20
7435	0.70	0.68	7514	0.28	0.26	7482	1.30	1.20

Devices may be mixed to qualify for quantity price. Data is available for the above series of ICs in booklet form price 35p.

CMOS ICs

Type	Price	Type	Price	Type	Price	Type	Price
CD4000	£0.14	CD4018	£0.85	CD4032	£1.40	CD4056	£1.15
CD4001	£0.16	CD4019	£0.45	CD4033	£0.78	CD4059	£0.32
CD4002	£0.16	CD4020	£0.95	CD4040	£0.78	CD4070	£0.32
CD4006	£0.80	CD4021	£0.85	CD4041	£0.68	CD4071	£0.20
CD4007	£0.17	CD4022	£0.80	CD4042	£0.68	CD4072	£0.20
CD4008	£0.80	CD4023	£1.10	CD4043	£0.78	CD4081	£0.20
CD4009	£0.50	CD4024	£0.64	CD4044	£0.78	CD4082	£0.20
CD4010	£0.50	CD4025	£0.18	CD4045	£1.15	CD4510	£1.10
CD4011	£0.18	CD4026	£1.85	CD4046	£0.95	CD4511	£1.25
CD4012	£0.17	CD4027	£0.48	CD4047	£0.75	CD4516	£1.10
CD4013	£0.42*	CD4028	£0.80	CD4049	£0.46	CD4518	£1.10
CD4015	£0.80	CD4029	£0.95	CD4050	£0.66	CD4520	£1.10
CD4016	£0.42	CD4030	£0.46	CD4054	£0.95		
CD4017	£0.80	CD4031	£1.80	CD4055	£1.60		

AUDIO MODULE SALE

Type	Description	Normal Price	Sale Price
AL30A	10W RMS Power AMP	£2.95	£2.95*
AL60	25W RMS Power AMP	£4.95	£3.55*
AL80	35W RMS Power AMP	£6.95	£5.95*
AL250	125W RMS Power AMP	£15.95	£14.45*
SPM80	35V Power Supply	£3.75	£3.10*
PS12	20-30V Power Supply for AL30A	£1.90	£1.15*
PA12	Stereo Pre-Amp for AL30A	£6.90	£5.95*
PA100	Stereo Pre-Amp for AL60/AL80	£13.99	£12.45*
S450	Stereo F.M. Tuner	£20.95	£18.65*
MPA30	Magnetic-Ceramic Pre-Amp	£2.85	£2.55*
Stereo 30	Complete Audio Chassis 7W + 7W RMS	£16.25	£14.95*

LOOK & LISTEN! GE 100 NINE CHANNEL MONO-GRAPHIC EQUALIZER MODULE £19.50

The GE100 has nine 1 octave adjustments using integrated circuit active filters. Boost and Cut limits are ±12dB. Max. Voltage handling 2 V RMS, T.H.D. 0.05%, input impedance 100 K. Output impedance less than 10 K. Frequency response 20 Hz-20 KHz (3dB). The nine gain controls are centred at 50, 100, 200, 400, 800, 1 600, 3 200, 6 400 and 12 800 Hz. The suggested gain controls are 10 K LIN sliders (not supplied with the module) See Paks S31 and 16192

SG30 POWER SUPPLY BOARD FOR GE100 15 0-15 VOLTS £4.50

SEND S.A.E. FOR TECHNICAL DATA ON ALL AUDIO MODULES

SPECIAL OFFER! COMPONENT PAKS

Order No.	Quantity	Price
16184	200 approx. Resistor mixed values (Country weight)	40p*
16185	150 approx. Capacitor mixed values (Country weight)	40p*
16186	60 V/V Resistors mixed values	40p*
16187	2 pieces Assorted Ferrite rods	40p*
16188	2 pieces Tuning gauge/MW/LW	40p*
16189	30 resistors Single attend with assorted wire	40p*
16190	10 Reed switches	40p*
16191	3 Micro switches	40p*
16192	20 Assorted electrolytic trim types	40p*
16193	1 pack Assorted hardware nuts, bolts, etc.	40p*
16194	20 Assorted lag strips and panels	40p*
16195	15 Assorted control knobs	40p*
16196	15 Assorted Fuses 100mA-5 amp	40p*
16197	60 V/V Resistors mixed values	40p*
16198	30 resistors standard wire assorted colours	40p*

1/2 PRICE BARGAIN!

£4 worth (min. Value)
Electronic Project Books, Technical, Semiconductor Data and Equivs. — Books of Assorted Titles
Our Clearance Price —
£2 per bundle†
Order No. S80

SUPER SOUND SAVING

C60 METROSOUND LOW NOISE CASSETTES C60s

Order No. 553 10 for £2.50*

BIB GROOVE CLEAN

Model 60 Chrome Finish Plastic
Order No. 829 £1.40*

HOT OFFER

ANTEX SOLDERING IRONS

Order No.	Description	Price
1931	X25 25watt LOW LEAKAGE Usually £3.40	Sale Price £2.95 PLUS FREE Heatshunt
1948	Model C 15watt GENERAL PURPOSE Usually £3.40	Sale Price £2.95 PLUS FREE Heatshunt
1939	ST3 Soldering Iron Stand, suitable for either iron	£1.20

NEW Siren Alarm Module

American Police siren powered from any 12 volt supply into 4 or 8 ohm speaker. Ideal for car burglar alarm, freezer breakdown and other security purposes. Order No. S15 Only £3.60

AVDEL BOND

Cyanacrylate adhesive Bonds plastic, rubber, Transistors. Components in Seconds.
Order No. 143 55p per 2 gm. phial

ORDERING

Please word your orders exactly as printed, not forgetting to include our part number.

VAT

Add 12 1/2% to prices marked *
Add 8% to others excepting those marked †. These are zero.

BI-PAK

Dept. WW2, P.O. Box 6, Ware

Herts

COMPONENTS SHOP:

18 BALDOCK STREET, WARE, HERTS.

FOR RELIABLE JOINTS — ANTEX IRONS!

HART ELECTRONICS

The Only Firm for Quality Audio Kits

Are proud to offer the only
DESIGNER APPROVED kit for the

J. L. Linsley-Hood High Quality Cassette Recorder



As these circuits are capable of such an excellent performance we feel that it is not sensible to sacrifice this potential by designing a kit down to a price. We have therefore spent a little more on professional hardware allowing us to design a very advanced modular system. This enables a more satisfactory electrical layout to be achieved, particularly around the very critical input areas of the replay preamps. These are totally stable with this layout and require no extra stabilising components. Many other advantages also come from this system which has separate record and replay amps for each channel plugging in to a master board with gold-plated sockets. The most obvious is the reduction of crosstalk and interaction which could cause trouble on a single plane board, with our modular system the layout is compact but there is no component crowding. Testing is very easy with separate identical modules and building with the aid of our component-by-component instructions is childishly simple, but the finished result is a unit designed not to normal domestic standards but to the best professional practice.

All printed circuits are of glassfibre material, fully drilled with a finished finish for easy and reliable soldering. Component locations are printed on the reverse side of the board and are arranged so that all identification numbers are still visible after assembly.

- 71x Complete set of parts for Master Board, includes bias oscillator, relay, controls, etc. £9.83 + £1.23 VAT
- 72x Parts for Motor Speed and Solenoid Control for Linsley-Hood CRV deck. This is the proper board layout as given in the articles. £3.52 + 44p VAT
- 73x Complete set of parts for stereo Replay Amps and VU Meter drive. £8.12 + £1.02 VAT
- 74x Complete set for stereo Record Amps. £6.74 + 84p VAT
- 75x Complete set of parts for Stabilised Power Supply to circuit given in Article. This uses a special low hum field transformer with better characteristics than the commonly used toroid. £8.79 + £1.10 VAT

ALL PARTS ARE POST FREE

Please send 9 x 4 SAE for lists giving fuller details and Price breakdowns

Penylan Mill, Oswestry, Salop

Personal callers are always welcome
but please note we are closed all day Saturday

700M2 individual High Quality VU Meters with excellent ballistics. £8.48 + £1.06 VAT. Per Pair

700C/2 High Quality Custom built steel Case. Complete with Brushed aluminium front plate, mains switch, record microswitch, turned record level knob, plastic cabinet feet, all bolts, nuts and mounting hardware. All necessary holes are punched and all surfaces are electroplated. Complete step-by-step assembly instructions are included. The cover is finished in an attractive black crackle surface. £16.50 + £2.06 VAT

LENCO CRV CASSETTE MECHANISM

High Quality, robust cassette transport for Linsley-Hood recorder. Features fast forward, fast rewind, record, pause and full auto stop and cassette ejection facilities. Fitted with Record 7 play and erase heads and supplied complete with Data and extra cassette ejection spring for above horizontal use. Price £21.60 + £2.70 VAT

Total cost of all parts £93.58

Special offer for Complete Kits £81.50 + £10.19 VAT

Optional extra solid teak end cheeks, £3 pair + 38p VAT

(Reprint of 3 Linsley-Hood Cassette Recorder articles. 48p post and VAT free.)

We also supply complete kits to make a fully integrated 30 watt stereo amplifier using the Bailey Power Amplifier circuit and the Bailey / Burrows Pre-amplifier with the Quilter Tone control modification.

Printed circuits and components are available for the Stuart tape circuits. These articles assembled a high quality tape link circuit for use with a reel-to-reel deck. Reprints of the three articles are available from us price 40p. Post Free (No VAT)

Trader YEARBOOK 1978/9



*Think of it
as your
right hand...*

There are times when trade information can make or break your business – and then this is the book to have around. It brings you a proprietary names directory, buyers' guide, Trade addresses, Electricity Board addresses, Trade organisations, radio and electrical wholesalers, service depots and agents – plus a really comprehensive legal guide that covers just about everything you'll ever need to know. Get it and there's one question you'll ask yourself: "What did I do without it?"

ELECTRICAL AND ELECTRONIC TRADER YEAR BOOK 1978/79

MAIL THIS COUPON NOW

To: IPC Electrical-Electronic Press Ltd.,
General Sales Department, C.P. 34 Dorset House,
Stamford Street, London SE1 9LU

Please send me.....copy ies of the Electrical and Electronic
Trader Year Book 1978/9. I enclose cheque p.o. number.....
to the value of £.....(£5.50 per copy inclusive). Cheques
payable to IPC Business Press Ltd.

Name (please print)

Address

Company registered in England No. 677128.
Regd. office: Dorset House, Stamford Street, London SE1 9LU

LANGREX SUPPLIES LTD

Climax House, Fallsbrook Rd., Streatham, London SW16 6ED

RST
Tel: 01-677 2424 Telex: 946708

RST

SEMICONDUCTORS

AA115 0.30	AS215 1.25	BC177 0.18	BD137 0.37*	HE107 0.58*	CM6078A 1.50	OC10 1.25	2T3031 0.20*	2N1835 0.31	2N3813 0.36*
AA190 0.10	AS216 1.25	BC178 0.18	BD138 0.40*	HE108 0.55*	KS1010 0.90	OC10A 2.50	2T3030 0.16*	2N1837 1.40	2N3820 0.46*
AA193 0.11	AS217 1.25	BC179 0.18	BD139 0.47*	HE109 0.57*	MJE300 0.58	OC12 2.50	2N3031 1.25	2N1844 1.45	2N3823 0.60*
AA194 0.15	AS220 0.75	BC180 0.18*	BD140 1.80	HE110 0.57*	MJE301 0.58	OC13 2.50	OC14 0.43	2N1845 0.65	2N3824 1.00
AA213 0.23	AS221 1.50	BC181 0.11*	BD141 1.18	HE111 0.58*	MJE302 0.65	OC15 2.50	OC16 0.66	2N1846 0.66	2N3825 0.21*
AA215 0.31	AS222 1.70*	BC182 0.12*	BD142 1.48	HE112 0.59	MJE303 0.65	OC16 2.50	OC17 0.22*	2N1847 0.66	2N3826 0.22*
AA217 0.25	AS223 1.70*	BC183 0.12*	BD143 1.48	HE113 0.59	MJE304 0.65	OC17 2.50	OC18 0.22*	2N1848 0.66	2N3827 0.22*
AA218 0.25	AS224 1.70*	BC184 0.12*	BD144 1.48	HE114 0.59	MJE305 0.65	OC18 2.50	OC19 0.22*	2N1849 0.66	2N3828 0.22*
AA219 0.25	AS225 1.70*	BC185 0.12*	BD145 1.48	HE115 0.59	MJE306 0.65	OC19 2.50	OC20 0.22*	2N1850 0.66	2N3829 0.22*
AA220 0.25	AS226 1.70*	BC186 0.12*	BD146 1.48	HE116 0.59	MJE307 0.65	OC20 2.50	OC21 0.22*	2N1851 0.66	2N3830 0.22*
AA221 0.25	AS227 1.70*	BC187 0.12*	BD147 1.48	HE117 0.59	MJE308 0.65	OC21 2.50	OC22 0.22*	2N1852 0.66	2N3831 0.22*
AA222 0.25	AS228 1.70*	BC188 0.12*	BD148 1.48	HE118 0.59	MJE309 0.65	OC22 2.50	OC23 0.22*	2N1853 0.66	2N3832 0.22*
AA223 0.25	AS229 1.70*	BC189 0.12*	BD149 1.48	HE119 0.59	MJE310 0.65	OC23 2.50	OC24 0.22*	2N1854 0.66	2N3833 0.22*
AA224 0.25	AS230 1.70*	BC190 0.12*	BD150 1.48	HE120 0.59	MJE311 0.65	OC24 2.50	OC25 0.22*	2N1855 0.66	2N3834 0.22*
AA225 0.25	AS231 1.70*	BC191 0.12*	BD151 1.48	HE121 0.59	MJE312 0.65	OC25 2.50	OC26 0.22*	2N1856 0.66	2N3835 0.22*
AA226 0.25	AS232 1.70*	BC192 0.12*	BD152 1.48	HE122 0.59	MJE313 0.65	OC26 2.50	OC27 0.22*	2N1857 0.66	2N3836 0.22*
AA227 0.25	AS233 1.70*	BC193 0.12*	BD153 1.48	HE123 0.59	MJE314 0.65	OC27 2.50	OC28 0.22*	2N1858 0.66	2N3837 0.22*
AA228 0.25	AS234 1.70*	BC194 0.12*	BD154 1.48	HE124 0.59	MJE315 0.65	OC28 2.50	OC29 0.22*	2N1859 0.66	2N3838 0.22*
AA229 0.25	AS235 1.70*	BC195 0.12*	BD155 1.48	HE125 0.59	MJE316 0.65	OC29 2.50	OC30 0.22*	2N1860 0.66	2N3839 0.22*
AA230 0.25	AS236 1.70*	BC196 0.12*	BD156 1.48	HE126 0.59	MJE317 0.65	OC30 2.50	OC31 0.22*	2N1861 0.66	2N3840 0.22*
AA231 0.25	AS237 1.70*	BC197 0.12*	BD157 1.48	HE127 0.59	MJE318 0.65	OC31 2.50	OC32 0.22*	2N1862 0.66	2N3841 0.22*
AA232 0.25	AS238 1.70*	BC198 0.12*	BD158 1.48	HE128 0.59	MJE319 0.65	OC32 2.50	OC33 0.22*	2N1863 0.66	2N3842 0.22*
AA233 0.25	AS239 1.70*	BC199 0.12*	BD159 1.48	HE129 0.59	MJE320 0.65	OC33 2.50	OC34 0.22*	2N1864 0.66	2N3843 0.22*
AA234 0.25	AS240 1.70*	BC200 0.12*	BD160 1.48	HE130 0.59	MJE321 0.65	OC34 2.50	OC35 0.22*	2N1865 0.66	2N3844 0.22*
AA235 0.25	AS241 1.70*	BC201 0.12*	BD161 1.48	HE131 0.59	MJE322 0.65	OC35 2.50	OC36 0.22*	2N1866 0.66	2N3845 0.22*
AA236 0.25	AS242 1.70*	BC202 0.12*	BD162 1.48	HE132 0.59	MJE323 0.65	OC36 2.50	OC37 0.22*	2N1867 0.66	2N3846 0.22*
AA237 0.25	AS243 1.70*	BC203 0.12*	BD163 1.48	HE133 0.59	MJE324 0.65	OC37 2.50	OC38 0.22*	2N1868 0.66	2N3847 0.22*
AA238 0.25	AS244 1.70*	BC204 0.12*	BD164 1.48	HE134 0.59	MJE325 0.65	OC38 2.50	OC39 0.22*	2N1869 0.66	2N3848 0.22*
AA239 0.25	AS245 1.70*	BC205 0.12*	BD165 1.48	HE135 0.59	MJE326 0.65	OC39 2.50	OC40 0.22*	2N1870 0.66	2N3849 0.22*
AA240 0.25	AS246 1.70*	BC206 0.12*	BD166 1.48	HE136 0.59	MJE327 0.65	OC40 2.50	OC41 0.22*	2N1871 0.66	2N3850 0.22*
AA241 0.25	AS247 1.70*	BC207 0.12*	BD167 1.48	HE137 0.59	MJE328 0.65	OC41 2.50	OC42 0.22*	2N1872 0.66	2N3851 0.22*
AA242 0.25	AS248 1.70*	BC208 0.12*	BD168 1.48	HE138 0.59	MJE329 0.65	OC42 2.50	OC43 0.22*	2N1873 0.66	2N3852 0.22*
AA243 0.25	AS249 1.70*	BC209 0.12*	BD169 1.48	HE139 0.59	MJE330 0.65	OC43 2.50	OC44 0.22*	2N1874 0.66	2N3853 0.22*
AA244 0.25	AS250 1.70*	BC210 0.12*	BD170 1.48	HE140 0.59	MJE331 0.65	OC44 2.50	OC45 0.22*	2N1875 0.66	2N3854 0.22*
AA245 0.25	AS251 1.70*	BC211 0.12*	BD171 1.48	HE141 0.59	MJE332 0.65	OC45 2.50	OC46 0.22*	2N1876 0.66	2N3855 0.22*
AA246 0.25	AS252 1.70*	BC212 0.12*	BD172 1.48	HE142 0.59	MJE333 0.65	OC46 2.50	OC47 0.22*	2N1877 0.66	2N3856 0.22*
AA247 0.25	AS253 1.70*	BC213 0.12*	BD173 1.48	HE143 0.59	MJE334 0.65	OC47 2.50	OC48 0.22*	2N1878 0.66	2N3857 0.22*
AA248 0.25	AS254 1.70*	BC214 0.12*	BD174 1.48	HE144 0.59	MJE335 0.65	OC48 2.50	OC49 0.22*	2N1879 0.66	2N3858 0.22*
AA249 0.25	AS255 1.70*	BC215 0.12*	BD175 1.48	HE145 0.59	MJE336 0.65	OC49 2.50	OC50 0.22*	2N1880 0.66	2N3859 0.22*
AA250 0.25	AS256 1.70*	BC216 0.12*	BD176 1.48	HE146 0.59	MJE337 0.65	OC50 2.50	OC51 0.22*	2N1881 0.66	2N3860 0.22*
AA251 0.25	AS257 1.70*	BC217 0.12*	BD177 1.48	HE147 0.59	MJE338 0.65	OC51 2.50	OC52 0.22*	2N1882 0.66	2N3861 0.22*
AA252 0.25	AS258 1.70*	BC218 0.12*	BD178 1.48	HE148 0.59	MJE339 0.65	OC52 2.50	OC53 0.22*	2N1883 0.66	2N3862 0.22*
AA253 0.25	AS259 1.70*	BC219 0.12*	BD179 1.48	HE149 0.59	MJE340 0.65	OC53 2.50	OC54 0.22*	2N1884 0.66	2N3863 0.22*
AA254 0.25	AS260 1.70*	BC220 0.12*	BD180 1.48	HE150 0.59	MJE341 0.65	OC54 2.50	OC55 0.22*	2N1885 0.66	2N3864 0.22*
AA255 0.25	AS261 1.70*	BC221 0.12*	BD181 1.48	HE151 0.59	MJE342 0.65	OC55 2.50	OC56 0.22*	2N1886 0.66	2N3865 0.22*
AA256 0.25	AS262 1.70*	BC222 0.12*	BD182 1.48	HE152 0.59	MJE343 0.65	OC56 2.50	OC57 0.22*	2N1887 0.66	2N3866 0.22*
AA257 0.25	AS263 1.70*	BC223 0.12*	BD183 1.48	HE153 0.59	MJE344 0.65	OC57 2.50	OC58 0.22*	2N1888 0.66	2N3867 0.22*
AA258 0.25	AS264 1.70*	BC224 0.12*	BD184 1.48	HE154 0.59	MJE345 0.65	OC58 2.50	OC59 0.22*	2N1889 0.66	2N3868 0.22*
AA259 0.25	AS265 1.70*	BC225 0.12*	BD185 1.48	HE155 0.59	MJE346 0.65	OC59 2.50	OC60 0.22*	2N1890 0.66	2N3869 0.22*
AA260 0.25	AS266 1.70*	BC226 0.12*	BD186 1.48	HE156 0.59	MJE347 0.65	OC60 2.50	OC61 0.22*	2N1891 0.66	2N3870 0.22*
AA261 0.25	AS267 1.70*	BC227 0.12*	BD187 1.48	HE157 0.59	MJE348 0.65	OC61 2.50	OC62 0.22*	2N1892 0.66	2N3871 0.22*
AA262 0.25	AS268 1.70*	BC228 0.12*	BD188 1.48	HE158 0.59	MJE349 0.65	OC62 2.50	OC63 0.22*	2N1893 0.66	2N3872 0.22*
AA263 0.25	AS269 1.70*	BC229 0.12*	BD189 1.48	HE159 0.59	MJE350 0.65	OC63 2.50	OC64 0.22*	2N1894 0.66	2N3873 0.22*
AA264 0.25	AS270 1.70*	BC230 0.12*	BD190 1.48	HE160 0.59	MJE351 0.65	OC64 2.50	OC65 0.22*	2N1895 0.66	2N3874 0.22*
AA265 0.25	AS271 1.70*	BC231 0.12*	BD191 1.48	HE161 0.59	MJE352 0.65	OC65 2.50	OC66 0.22*	2N1896 0.66	2N3875 0.22*
AA266 0.25	AS272 1.70*	BC232 0.12*	BD192 1.48	HE162 0.59	MJE353 0.65	OC66 2.50	OC67 0.22*	2N1897 0.66	2N3876 0.22*
AA267 0.25	AS273 1.70*	BC233 0.12*	BD193 1.48	HE163 0.59	MJE354 0.65	OC67 2.50	OC68 0.22*	2N1898 0.66	2N3877 0.22*
AA268 0.25	AS274 1.70*	BC234 0.12*	BD194 1.48	HE164 0.59	MJE355 0.65	OC68 2.50	OC69 0.22*	2N1899 0.66	2N3878 0.22*
AA269 0.25	AS275 1.70*	BC235 0.12*	BD195 1.48	HE165 0.59	MJE356 0.65	OC69 2.50	OC70 0.22*	2N1900 0.66	2N3879 0.22*
AA270 0.25	AS276 1.70*	BC236 0.12*	BD196 1.48	HE166 0.59	MJE357 0.65	OC70 2.50	OC71 0.22*	2N1901 0.66	2N3880 0.22*
AA271 0.25	AS277 1.70*	BC237 0.12*	BD197 1.48	HE167 0.59	MJE358 0.65	OC71 2.50	OC72 0.22*	2N1902 0.66	2N3881 0.22*
AA272 0.25	AS278 1.70*	BC238 0.12*	BD198 1.48	HE168 0.59	MJE359 0.65	OC72 2.50	OC73 0.22*	2N1903 0.66	2N3882 0.22*
AA273 0.25	AS279 1.70*	BC239 0.12*	BD199 1.48	HE169 0.59	MJE360 0.65	OC73 2.50	OC74 0.22*	2N1904 0.66	2N3883 0.22*
AA274 0.25	AS280 1.70*	BC240 0.12*	BD200 1.48	HE170 0.59	MJE361 0.65	OC74 2.50	OC75 0.22*	2N1905 0.66	2N3884 0.22*
AA275 0.25	AS281 1.70*	BC241 0.12*	BD201 1.48	HE171 0.59	MJE362 0.65	OC75 2.50	OC76 0.22*	2N1906 0.66	2N3885 0.22*
AA276 0.25	AS282 1.70*	BC242 0.12*	BD202 1.48	HE172 0.59	MJE363 0.65	OC76 2.50	OC77 0.22*	2N1907 0.66	2N3886 0.22*
AA277 0.25	AS283 1.70*	BC243 0.12*	BD203 1.48	HE173 0.59	MJE364 0.65	OC77 2.50	OC78 0.22*	2N1908 0.66	2N3887 0.22*
AA278 0.25	AS284 1.70*	BC244 0.12*	BD204 1.48	HE174 0.59	MJE365 0.65	OC78 2.50	OC79 0.22*	2N1909 0.66	2N3888 0.22*
AA279 0.25	AS285 1.70*	BC245 0.12*	BD205 1.48	HE175 0.59	MJE366 0.65	OC79 2.50	OC80 0.22*	2N1910 0.66	2N3889 0.22*
AA280 0.25	AS286 1.70*	BC246 0.12*	BD206 1.48	HE176 0.59	MJE367 0.65	OC80 2.50	OC81 0.22*	2N1911 0.66	2N3890 0.22*
AA281 0.25	AS287 1.70*	BC247 0.12*	BD207 1.48	HE177 0.59	MJE368 0.65	OC81 2.50	OC82 0.22*	2N1912 0.66	2N3891 0.22*
AA282 0.25	AS288 1.70*	BC248 0.12*	BD208 1.48	HE178 0.59	MJE369 0.65	OC82 2.50	OC83 0.22*	2N1913 0.66	2N3892 0.22*
AA283 0.25	AS289 1.70*	BC249 0.12*	BD209 1.48	HE179 0.59	MJE370 0.65	OC83 2.50	OC84 0.22*	2N1914 0.66	2N3893 0.22*
AA284 0.25	AS290 1.70*	BC250 0.12*	BD210 1.48	HE180 0.59	MJE371 0.65	OC84 2.50	OC85 0.22*	2N1915 0.66	2N3894 0.22*
AA285 0.25	AS291 1.70*	BC251 0.12*	BD211 1.48	HE181 0.59	MJE372 0.65	OC85 2.50	OC86 0.22*	2N1916 0.66	2N3895 0.22*
AA286 0.25	AS292 1.70*	BC252 0.12*	BD212 1.48	HE182 0.59	MJE373 0.65	OC86 2			



NEW PRODUCTS!

NRDC-AMBISONIC 45J



SURROUND SOUND DECODER

The first ever kit specially produced by Integrex for this British NRDC backed surround sound system which is the result of 7 years' research by the Ambisonic team, W.W. July, Aug., '77.

The unit is designed to decode not only 45J but virtually all other 'quadrophonic' systems (Not CD4), including the new BBC Matrix H.10 input selections.

The decoder is linear throughout and does not rely on listener fatiguing logic enhancement techniques. Both 2 or 3 input signals and 4 or 6 output signals are provided in this most versatile unit. Complete with mains power supply, wooden cabinet, panel, knobs, etc.

Complete kit, including licence fee **£45.00 + VAT**
or ready built and tested **£61.50 + VAT**

INTRUDER 1 RADAR ALARM

With Home Office Type approval

As in "Wireless World", designed by Mike Hosking, 240V ac mains operated and disguised as a hardbacked book. Detection range up to 30 feet.

Complete exclusive designer approved kit **£46.00 + VAT**
or ready built and tested, **£54.00 + VAT**



Wireless World DolbyTM noise reducer

Trademark of Dolby Laboratories Inc.



Featuring:

- Switching for both encoding (low-level h.f. compression) and decoding
- a switchable f.m. stereo multiplex and bias filter.
- provision for decoding Dolby f.m. radio transmissions (as in USA)
- no equipment needed for alignment.
- suitability for both open-reel and cassette tape machines.
- check tape switch for encoded monitoring in three-head machines.

Typical performance

Noise reduction better than 9dB weighted.
Clipping level 16.5dB above Dolby level (measured at 1% third harmonic content)

Harmonic distortion 0.1% at Dolby level typically 0.05% over most of band, rising to a maximum of 0.12%

Signal-to-noise ratio 75dB (20Hz to 20kHz, signal at Dolby level) at Monitor output

Dynamic Range >90dB

30mV sensitivity.

Complete Kit **PRICE: £39.90 + VAT**

Also available ready built and tested **Price £54.00 + VAT**

Calibration tapes are available for open-reel use and for cassette (specify which) **Price £2.20 + VAT**

Single channel plug-in DolbyTM PROCESSOR BOARDS (92 x 87mm) with gold plated contacts are available with all components **Price £8.20 + VAT**

Single channel board with selected fet **Price £2.50 + VAT**

Gold Plated edge connector **Price £1.50 + VAT***

Selected FETs **60p** each + VAT, **100p** + VAT for two, **£1.90** + VAT for four

Please add VAT @ 12½% unless marked thus*, when 8% applies (or current rates)

We guarantee full after-sales technical and servicing facilities on all our kits, have you checked that these services are available from other suppliers?



INTEGREX LTD.

Please send SAE for complete lists and specifications
Portwood Industrial Estate, Church Gresley,
Burton-on-Trent, Staffs DE11 9PT
Burton-on-Trent (0283) 215432 Telex 377106

INTEGREX

S-2020TA STEREO TUNER/AMPLIFIER KIT

SOLID MAHOGANY CABINET

A high-quality push-button FM Varicap Stereo Tuner combined with a 24W r.m.s. per channel Stereo Amplifier.



Brief Spec. Amplifier Low field Toroidal transformer, Mag. input, Tape In/Out facility (for noise reduction unit, etc.), THD less than 0.1% at 20W into 8 ohms. Power on/off FET transient protection. All sockets, fuses, etc., are PC mounted for ease of assembly. Tuner section uses 3302 FET module requiring no RF alignment, ceramic IF, INTERSTATION MUTE, and phase-locked IC stereo decoder. LED tuning and stereo indicators. Tuning range 88-104MHz. 30dB mono S/N @ 1.2µV. THD 0.3%. Pre-decoder 'birdy' filter.

PRICE: £58.95 + VAT

NELSON-JONES STEREO FM TUNER KIT

A very high performance tuner with dual gate MOSFET RF and Mixer front end, triple gang varicap tuning, and dual ceramic filter/dual IC IF amp.



Brief Spec. Tuning range 88-104MHz. 20dB mono quieting @ 0.75µV. Image rejection - 70dB. IF rejection - 85dB. THD typically 0.4%.

IC stabilized PSU and LED tuning indicators. Push-button tuning and AFC unit. Choice of either mono or stereo with a choice of stereo decoders.

Compare this spec. with tuners costing twice the price.

Mono £32.40 + VAT

With ICPL Decoder £36.67 + VAT

With Portus-Haywood Decoder

£39.20 + VAT



Sens. 30dB S/N mono @ 1.2µV
THD typically 0.3%
Tuning range 88-104MHz
LED sig. strength and stereo indicator

STEREO MODULE TUNER KIT

A low-cost Stereo Tuner based on the 3302 FET RF module requiring no alignment. The IF comprises a ceramic filter and high-performance IC Variable INTERSTATION MUTE. PLL stereo decoder IC. Pre-decoder 'birdy' filter Push-button tuning

PRICE: Stereo £31.95 + VAT



S-2020A AMPLIFIER KIT

Developed in our laboratories from the highly successful "TEXAN" design. PC mounting potentiometers, switches, sockets and fuses are used for ease of assembly and to minimize wiring

Power 'on/off' FET transient protection.

Typ Spec. 24+24W r.m.s. into 8-ohm load at less than 0.1% THD. Mag. PU input S/N 60dB. Radio input S/N 72dB. Headphone output. Tape In/Out facility (for noise reduction unit, etc.). Toroidal mains transformer.

PRICE: £33.95 + VAT

ALL THE ABOVE KITS ARE SUPPLIED COMPLETE WITH ALL METALWORK, SOCKETS, FUSES, NUTS AND BOLTS, KNOBS, FRONT PANELS, SOLID MAHOGANY CABINETS AND COMPREHENSIVE INSTRUCTIONS

BASIC NELSON-JONES TUNER KIT	£14.28 + VAT	PHASE-LOCKED IC DECODER KIT	£4.47 + VAT
BASIC MODULE TUNER KIT (stereo)	£16.75 + VAT	PUSH-BUTTON UNIT	£5.00 + VAT
PORTUS-HAYWOOD PHASE-LOCKED STEREO DECODER KIT			£8.00 + VAT

U.K. RETURN OF POST MAIL ORDER SERVICE, ALSO WORLDWIDE EXPORT SERVICE

BSR HI-FI AUTOCHANGER STEREO AND MONO £21.50 Post 75p

Plays 12", 10" or 7" records. Auto or Manual. A high quality unit backed by BSR reliability with 12 months guarantee. A.C. 200/250V. Size 13 1/2" x 11 1/2". 3 speeds. Above motor board 35in. Below motor board 2 1/2in. with Sonotone V100 magnetic cartridge.



B.S.R. P128 with magnetic cartridge. Balanced arm. Cueing device. Bias Compensator. £24.50. Post £1.

PORTABLE PLAYER CABINET
Modern design. Rexine covered. Vynair front grille. Chrome fittings. Size 17 x 15 x 8in. approx. Motor board cut for BSR or Garrard deck. £4.50 Post 75p

HEAVY METAL PLINTHS
With P.V.C. Cover. Cut out for most B.S.R. or Garrard decks. Silver grey finish. Model 'A' Size 12 1/2 x 14 1/4 x 7 1/2in. Model 'B' Size 16 x 13 1/4 x 7in. Extra large plinth & cover. Teak wood base. Size 20" x 17 1/2" x 9" £18.50. Callers only. £6.50 Post £1.50 £7.50

BSR SINGLE PLAYER
Ideal replacement or disco deck with cueing device and stereo ceramic cartridge. £15.50 Post 75p.



ELAC HI-FI SPEAKER 8in. TWIN CONE
Dual cone plastic rail surround. Large ceramic magnet. 50-16,000 c/s. Bass resonance 40 c/s. 8 ohm impedance. 15 watts RMS. £5.95 Post 35p.



SMITH'S CLOCKWORK 15 AMP TIME SWITCH 0-6 HOURS £3.30 Post 35p
Single pole two-way. Surface mounting with fixing screws. Will replace existing wall switch to give light for return home, garage, automatic anti-burglar lights, etc. Variable knob. Turn on or off at full or intermediate settings. Brand new.



TEAKWOOD LOUSPEAKER GRILLES will easily fit to baffle board. Size 10 1/2 x 7 1/2in. - £5p.

R.C.S. "MINOR" 10 watt AMPLIFIER KIT
This kit is suitable for record players, guitars, tape playback electronic instruments or small P.A. systems. Two versions available: Mono, £11.25; Stereo, £18. Post 45p. Specification 10W per channel; input 100mV; size 9 1/2" x 3 x 2in. approx. S.A.E. details. Full instructions supplied. AC mains powered.

VOLUME CONTROLS 5kΩ to 2MΩ. LOG or LIN. L/S 35p. D.P. 60p. STEREO L/S 85p. D.P. £1. Edge 5k. S.P. Transistor 45p.
80 Ohm Coax 8p yd. FRINGE LOW LOSS 15p yd. Ideal 625 and colour PLUGS 10p. SOCKETS 10p. LINE SOCKETS 18p. OUTLET BOXES 60p.

ELAC 9 x 5in HI-FI SPEAKER TYPE 59RM £3.45 Post 35p
This famous unit now available. 10 watts. 8 ohm.

E.M.I. 13 1/2 x 8in. SPEAKER SALE!
With tweeter and crossover. 10 watt 3 ohm £7.95 Post 45p
Ditto 15 watts, 8 ohm £10.50 Post 65p



With tweeter and crossover. 20 watt. Bass res. 25 c/s. Flux=11,000 gauss. 8 or 15 ohm. 20 to 20,000 c/s. £11.50 Post 75p
Bookshelf Cabinet Teak finish. For EM1 13 x 8 speakers. £8.50 Post £1.00

THE "INSTANT" BULK TAPE ERASER AND HEAD DEMAGNETISER. Suitable for cassettes, and all sizes of tape reels. A.C. mains 200/250V. Leaflet S.A.E. We also demagnetise small tools. £4.95 Post 50p



BLANK ALUMINIUM CHASSIS. 5 x 4-70p; 8 x 8-90p; 10 x 7-£1.15; 12 x 8-£1.35; 14 x 9-£1.50; 16 x 8-£1.45; 16 x 10-£1.70. **ANGLE ALL.** 5 x 4 x 3in. -18p.
ALUMINIUM PANELS. 5 x 4-17p; 8 x 8-24p; 14 x 3-25p; 10 x 7-35p; 12 x 8-43p; 12 x 5-30p; 16 x 5-43p; 14 x 9-52p; 12 x 12-68p; 16 x 10-75p.
ALL BOXES IN STOCK. MANY SIZES
VARIABLE FM TUNER HEAD with circuit & connections £4.95. TAG STRIP 7B-ray 12p.
TAPE OSCILLATOR COIL. Valve type 35p.
BRIDGE RECTIFIER 200V MIV 50p.
TOGGLE SWITCHES S.P. 30p. D.P. S.T. 40p. D.P.D. 50p.
MANY OTHER TOGGLES IN STOCK.
PICK-UP CARTRIDGES ACOS GP91 £1.50. GP93 £2.50. SONOTONE stereo £2.00. SHURE M70 £5.00.
WIREWOUND RESISTORS 5 watt, 10 watt, 15 watt. 10 ohms to 50K 12p each.

R.C.S. SOUND TO LIGHT KIT £17 Post 35p
Kit of parts to build a 3 channel sound to light unit. 1,000 watts per channel. Easy to build. Full instructions supplied. Cabinet £3.

R.C.S. LOW VOLTAGE STABILISED POWER PACK KITS £2.95 Post 45p
All parts and instructions with Zener diode printed circuit rectifiers and double wound mains transformer. Input 200-240V a.c. Output voltages available, 6 or 7.5 or 9 or 12V d.c. up to 100mA or less. Size 3 x 2 1/2 x 1 1/2in. Please state voltage required.

R.C.S. POWER PACK KIT £3.35 Post 30p
12 VOLT 750mA. Complete with printed circuit board and assembly instructions.
12 VOLT 300mA KIT £3.15; 9 VOLT 1 AMP KIT. £3.35.

R.C.S. GENERAL PURPOSE TRANSISTOR PRE-AMPLIFIER - BRITISH MADE £1.45 Post 30p
Ideal for Mike, Tape, P.U., Guitar, etc. Can be used with battery 9-12V or H.T. Line 200-300V d.c. operation. Size 1 1/4 x 1 1/4 x 1 1/4in. Resonance 25 c/s to 25 kc/s. 25 dB gain. For use with valve or transistor equipment. Full instructions supplied. Details S.A.E.

RCS DRILL SPEED CONTROLLER/LIGHT DIMMER KIT. £3.25 Post 35p
Easy to build kit. Will control up to 500 watts AC mains.

RCS STEREO PRE-AMP KIT. £2.95 Post 35p
Inputs for high, medium or low imp. per channel, with volume control and P.C. Board. Can be ganged to make multi-way mixers.

MAINS TRANSFORMERS ALL POST 60p.

250-0-250V 70mA, 6.3V 2A	£3.45
250-0-250V 100mA, 6.3V 3.5A, 8.3V 1A or 5V 2A	£4.50
350-0-350V 80mA, 6.3V 3.5A, 8.3V 1A or 5V 2A	£5.80
300-0-300V 120mA, 2X6.3V 2A CT. 5V 2A	£6.50
220V 45mA, 6.3V 2A	£1.75
HEATED TRANS. 6.3V 5amp	£1.00
3 amp	£1.40

GENERAL PURPOSE LOW VOLTAGE Tappanquist 2 amp 3 4 5 6 8 9 10 12 15 18 25 and 30V

1 amp 6.3 10 12 15 18 20 24 30 35 40 45 50	£3.30
2 amp 6.3 10 12 15 18 20 24 30 35 40 45 50	£5.50
3 amp 6.3 10 12 15 18 20 24 30 35 40 45 50	£11.00
5 amp 6.3 10 12 15 18 20 24 30 35 40 45 50	£16.50

12V 100mA £1.00 20V 30V 60V 1 amp £3.50
12V 750mA £1.00 12V 300mA £1.00
12V 3 amp £2.45 10V 30V 40V 2 amp £2.75
10V 1 amp 1.5V 1V 40V 2 amp £2.95
2 amp £3.45 20V 1 amp £2.20
0.5 5 10 15V 15 amp £1.95 20V 0.20V 1 amp £2.95
20V 15 amp £1.75 10V 0.30V 1 amp £7.00
20V 3 amp £2.50 2 1/2 1.5V 5 amp £5.00
30V 15 amp £2.75 2 1/2 1.5V 5 amp £5.00

AUTO TRANSFORMERS 115V to 230V or 230V to 115V 150V £5.00 250V £6.00 400V £7.00 200V £6.00
FULL WAVE BRIDGE CHARGER RECTIFIERS
8 or 12V outputs 1 1/2 amp £4.00
2 amp 75p 3 amp 1.00 4 amp 1.00
CHARGING TRANSFORMERS: 1 amp £3.50; 2 amp £6.80; 12V, 15 amp Half Wave Selenium Rectifier 25p

R.C.S. BOOKSHELF SPEAKERS £16 pair Post £1.30
15 x 10 x 6in. 50 to 14,000 cps. 8 watts rms. 4, 8 or 16 ohms.



GLOBAL SPEAKERS £3.95 ea.
These little marvels of modern sound reproduction are ideally suited for today's domestic audio set-up. Two of these smart spheres, each with 5 watt deep throated ceramic magnets, will produce superb stereo reproduction. The globe shaped cases in high gloss mouldings of red and green, are finished with chrome frontal trim and provided with screw-on rubber inset protective bases. In addition, 2 1/2 metres of strong lead already fitted with phone plug is supplied. Frequency Response 100-20,000 Hz. Impedance: 8 ohms. Power Capacity: 5 watts.

LOW VOLTAGE ELECTROLYTICS
1, 2, 4, 5, 8, 16, 25, 30, 50, 100, 200mF 15V 10p.
500mF 12V 15p; 25V 20p; 50V 30p;
1000mF 12V 17p; 25V 35p; 50V 47p; 100V 70p.
2000mF 6V 25p; 25V 42p; 420mF; 500V £1.30
2500mF 50V 62p; 3000mF 25V 47p; 50V 65p.
3900mF 100V £1.60, 4700mF 63V £1.20, 2700mF 76V £1.
5000mF 8V 25p; 12V 42p; 35V 85p; 5600mF 76V £1.75
MANY OTHER ELECTROLYTICS IN STOCK

SHORT WAVE 100pF air spaced gangable tuner. 95p.
TRIMMERS 10pF, 30pF, 50pF, 5p, 100pF, 150pF 15p.
CERAMIC, 1pF to 0.01mF, 5p. Silver Mica 2 to 5000pF, 5p.
PAPER 350V 0.1 7p; 0.5 13p; 1mF 150V 20p; 2mF 150V 20p; 500V 0.001 to 0.05 5p; 0.1 10p; 0.25 13p; 0.47 25p.
MICRO SWITCH SINGLE POLE CHANGE OVER 20p.
SUB-MIN MICRO SWITCH, 25p. Single pole change over
TWIN GANG, 365 = 385pF 50p; 500pF standard 75p;
365 + 365 + 25 + 25pF. Slow motion drive 65p.
120pF TWIN GANG, 50p; 365pF TWIN GANG, 50p.
NEON PANEL INDICATORS 250V. Amber or red 30p.
RESISTORS. 1/4W, 1W, 20K 2p; 2W, 10p; 10Ω to 10M
HIGH STABILITY. 1/4W 2p. 10 ohms to 5 meg. 12p.
Ditto 5p. Preferred values 10 ohms to 10 meg. 5p.

ELECTRO MAGNETIC PENDULUM MECHANISM 95p Post 30p
1.5V a.c. operation over 300 hours continuous on SP2 battery. Fully adjustable swing and speed. Ideal displays teaching electro magnetism or for: metronome, strobe, etc.

BAKER MAJOR 12" £15.00 Post £1.00

30-14,500 c/s. 12in. double cone woofer and tweeter cone together with a BAKER ceramic magnet assembly having a flux density of 14,000 gauss and a total flux of 145,000 Maxwells. Bass resonance 40 c/s. Rated 25W. NOTE: 4 or 8 or 16 ohms must be stated.
Module kit 30-17,000 c/s with tweeter, crossover, baffle and instructions. Post £1.80 each. Please state 4 or 8 or 16 ohms. £19.00

BAKER "BIG-SOUND" SPEAKERS. Post £1.00 each.
Group 25' 12in. 30W £12.00 4 or 8 or 16 ohm
Group 35' 12in. 40W £14.00 4 or 8 or 16 ohm
Group 50/15' 15in. 75W £26.00 8 or 16 ohm

BAKER LOUSPEAKER, 12INCH. 60 WATT. GROUP 50/12, 4 OR 8 OR 16 OHM HIGH POWER FULL RANGE PROFESSIONAL QUALITY RESPONSE 30-16,000 CPS MASSIVE CERAMIC MAGNET WITH ALUMINIUM PRESENCE CENTRE DOME Post £1.60 £21.00

TEAK VENEERED HI-FI SPEAKERS AND CABINETS
For 12in. or 10in. speaker 20x13x12in. £14.50 Post £2
For 13x8in. or 9in. speaker £8.50 Post £1
For 6 1/2in. speaker and tweeter 12x9x8in. £5.80 Post 75p
Many other cabinets in stock. Phone your requirements.

SPEAKER COVERING MATERIALS. Samples Large S.A.E. **LOUDSPEAKER CABINET WADDING** 18in. wide 20p ft.

R.C.S. 100 watt VALVE AMPLIFIER CHASSIS



Four inputs. Four way mixing, master volume, treble and bass controls. Suits all speakers. This professional quality amplifier chassis is suitable for all groups, disco, P.A., where high quality power is required. 5 speaker outputs. A/C mains operated. Slave output sockets. Produced by demand for a quality valve amplifier. 100W line output to order. Send for leaflet. Suitable carrying cab £16.50 Price £94 can. £2.50

Horn Tweeters 2-16k c/s. 10W 8 ohm or 16 ohm £3.60
De Luxe Horn Tweeters 3-18kc/s. 30W, 8 ohm, £7.50.
CROSSOVERS. TWO-WAY 3000 c/s or 8 or 15 ohm £1.90. 3-way 950 cps; 3000 cps. £2.20.
LOUDSPEAKERS P.M. 3 OHM 7x4in. £1.50; 6 1/2in. £1.80; 8x6in. £1.90; 8in. £1.95.
SPECIAL OFFER: 80 ohm 2 1/2in. 2 1/2in. 35 ohm 3in. 25 ohm 2 1/2in. 3in. 5x3in. 7x4in. 8 ohm 2 1/2in. 3in. 3 1/2in. 5in. 15 ohm 3in. 3 1/2in. 4in. 6x4in. 7x4in. 5x3in. 3 ohm 2 1/2in. 3 1/2in. 5in. 6in. £1.50 each.
PHILIPS LOUSPEAKER, 8in. 4 ohms. 4 watts. £1.95
RICHARD ALLAN TWIN CONE LOUSPEAKERS 8in. diameter 4W £2.50, 10in. diameter 5W £2.95; 12in. diameter 6W £3.50. 3/8 1/2 ohms, please state.
PIEZO ELECTRIC HORN TWEETER. Handles up to 100 watts. No crossover required. £7.95.
Tweeter Volume Control 15 ohms 10W with one inch long threaded bush for wood panel mounting. 1/4in. spindle. 65p.

BAKER 150 WATT PROFESSIONAL MIXER AMPLIFIER £75 £1.50 can.
All purpose transistorised. Ideal for Groups, Disco and P.A. 4 inputs speech and music. 4 way mixing. Output 4 8-16 ohms a.c. Mains. Separate treble and bass controls. Master volume control. Guaranteed. Details S.A.E.



100 WATT DISCO AMPLIFIER £59
volume, treble, bass controls. 500 M.V. or 1 volt input. Four loudspeaker outputs 4 to 16 ohm. All transistor.

GOODMANS COMPACT 12-INCH BASS WOOFER £10.95 each Post £1.00
Standard 12in. diameter being with outside 10 1/2 square. 14,000 Gauss magnet. 30 watts R.M.S. 4 ohm imp. Bass resonance = 30 cps. Frequency response 30-8000 c/s.



ALUMINIUM HEAT SINKS. FINISHED TYPE. Suits 6 1/2" x 4 1/2" x 2 1/2" 95p. 6 1/2" x 2 1/2" 75p.
BALANCED TWIN RIBBON FEEDER 300 ohms, 8p yd.
JACK SOCKET Std. open-circuit 20p, closed circuit 25p; Chrome Lead-Socket 45p. Mono or Stereo.
Phono Plugs 8p. Phono Socket 8p.
JACK PLUGS Std. Chrome 30p; Plastic 25p; 3.5mm 15p.
STEREO JACK PLUG 30p. SOCKET 25p.
DIN SOCKETS Chassis 3-pin 10p. 5-pin 10p.
DIN SOCKETS FREE 3-pin 25p; 5-pin 25p. DIN PLUGS 3-pin 25p; 5-pin 25p. VALVE HOLDERS, 10p; CANS 10p.
TV CONVERSION POTS 15p each
Values = 5, 7, 10, 20, 50, 100, 200, 250, 470, 2000 ohms.

MONO PRE-AMPLIFIER. Mains operated solid state pre-amplifier unit designed to complement amplifiers without low level phono and tape input stages. This free-standing cabinet incorporates circuitry for automatic R.I.A.A. equalisation on magnetic phono input and N.A.B. equalisation for tape needs. Power ON/OFF, PHONO/TAPE switches and pilot lamp are on the front panel; phono socket input and output are rear located. £4.50 each or £8 pair. Post 50p.



RADIO COMPONENT SPECIALISTS 337 WHITEHORSE ROAD, CROYDON
Open 9-6. Wed. 9-1. Sat. 9-5 (Closed for lunch 1.15-2.30)
Radio Books and Components lists 20p. (Minimum posting charge 30p.) Cash prices include VAT. (We accept Access or Barclaycard. Phone your Order) Tel. 01-684 1665



ELECTRONICS (LONDON) LTD.

NASCOM 1

Microcomputer for the Hobbyist

HARDWARE FEATURES:

- ★ SUPPLIED IN KIT FORM FOR SELF-ASSEMBLY
- ★ FULL DOCUMENTATION SUPPLIED
- ★ INCLUDES PRINTED CIRCUIT BOARD
- ★ FULL KEYBOARD INCLUDED
- ★ INTERFACES TO KEYBOARD, CASSETTE RECORDER & T.V.
- ★ 2K x 8 RAM
- ★ 1K x 8 EPROM MONITOR PROGRAM
- ★ POWERFUL Z80 CPU
- ★ 16 LINE x 48 CHARACTER DISPLAY INTERFACE TO STANDARD, UNMODIFIED T.V. SET
- ★ ON BOARD EXPANSION TO 2K x 8 EPROM
- ★ ON BOARD EXPANSION FACILITY FOR ADDITIONAL 16 LINES I/O
- ★ TOTAL EXPANSION TO 64K x 8 MEMORY
- ★ TOTAL EXPANSION TO 256 INPUT PORTS AND 256 OUTPUT PORTS

SOFTWARE FEATURES:

- ★ 1K x 8 'NASBUG' PROGRAM IN EPROM
- ★ PROVIDES 8 BASIC OPERATOR COMMANDS INCLUDING SINGLE STEP
- ★ EXPANDABLE SOFTWARE SYSTEM VIA ADDITIONAL USER PROGRAMS IN RAM OF EPROM

ACCESS

£197.50 (ex VAT)

BARCLAYCARD

Phone or write for details:

92 BROAD STREET, CHESHAM, BUCKS. TELEPHONE (02405) 75154



DATEST 1 TRANSISTOR AND OP. AMP. TESTER

Simplifies semiconductor testing
Saves time and errors

- ★ Tests are automatic and unambiguous
- ★ Tests devices in and out of circuit
- ★ Handles bipolars, FETs (all types), LEDs, diodes, op. amps. (out of circuit only)
- ★ Automatically displays device polarity and, for devices out of circuit, device type
- ★ Checks for gain, leakage, input offset

Price including test probes, full instructions and delivery (UK only): £43 plus VAT (8%). Data sheet on request

DATONG ELECTRONICS LIMITED
Spence Mills, Mill Lane, Bramley, Leeds LS13 3HE
Telephone: Pudsey (0532) 552461

WW-024 FOR FURTHER DETAILS



Audio Connectors

Broadcast pattern jackfields, jackcords, plugs and jacks.

Quick disconnect microphone connectors
Amphenol (Tuchel) miniature connectors with coupling nut.

Hirschmann Banana plugs and test probes
XLR compatible in-line attenuators, and reversers.

Low cost slider faders by Ruf.

Future Film Developments Ltd.
36-38 Lexington Street
London W1R 3HR
01-437 1892/3

WW-026 FOR FURTHER DETAILS

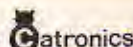

NEW FACILITIES AVAILABLE FOR WW TELETEXT DECODER

'Board 3' is now available as an additional unit to update the 'Wireless World' Teletext Decoder to give double height characters, colour background, conceal/reveal, etc., as described in December's issue of 'Wireless World.' Our Kit includes plated-through hole P.C.B., all components and installation instructions. Price £33.58 + VAT (£3.47) + P&P (30p) = £37.45 total.

PCB only available at £19.60.

Our main kits contain all the printed circuit boards and components necessary to build the complete decoder.

A reprint of the series of articles is available at £1.50 + large 15p SAE (included free in complete kit)

PRICES INCLUDE VAT

	Standard version using 2513	New version with Texas X887	Post & Packing
Set of 5 PCBs	£21.70	£21.65	30p
Component Kit (incl. PCBs)	£120.95	£133.70	£1.50
Add-on Unit for lower case PCB	£2.70	—	—
Component Kit (incl. PCB)	£13.75	—	—
Cabinet	£14.85	£14.85	£1.00

PLATED THROUGH HOLE PCBs for TEXAS version only at additional cost of £27.00

FULL FAULT-FINDING AND REPAIR SERVICE AVAILABLE.

COMPONENTS ALSO AVAILABLE SEPARATELY — SAE for price list

READY BUILT & TESTED DECODERS — £241.87 + £5 Carr.

DE LUXE VERSION WITH NEW FACILITIES — £292.50 + £5 Carr.

CHAR. GEN., MEMORY 7400 I.C.S.

TEXAS 74S262N (X887) NOW ONLY £16.00

SIGNETICS 2513 £8.50; NATIONAL 2102/2602/ £2.25

7400	19p	7420	19p	7475	56p	74145	£1.24	74183	£1.84
7402	19p	7421	28p	7483	£1.00	74150	£2.49	74185	£1.84
7403	19p	7427	34p	7485	£1.33	74153	90p	74196	£1.62
7404	24p	7428	47p	7486	35p	74157	90p	74221	£1.55
7406	44p	7430	21p	7490	58p	74164	£1.38	75107	£1.82
7408	26p	7432	38p	7492	60p	74165	£1.70	74H00	35p
7410	22p	7440	21p	7493	65p	74174	£1.19	74H04	44p
7411	22p	7442	84p	7496	97p	74175	£1.30	74H10	39p
7412	27p	7447	£1.00	74107	52p	74177	£1.40		
7413	38p	7473	40p	74121	43p	74180	£1.30		
7414	82p	7474	36p	74123	£1.05	74192	£1.84		

Quantity discount on 7400 Series only: 25-99 less 10%; 100 or more less 20%

THESE PRICES INCLUDE VAT. PLEASE ADD 30p P&P



CATRONICS LTD. (Dept. 822)
Communications House
20 WALLINGTON SQUARE
WALLINGTON, SURREY
Tel: 01-869 8700

WW-822 FOR FURTHER DETAILS

NEW GUINEA ISRAEL GUERNSEY CYPRUS BELGIUM UGANDA BRUNEI TRINIDAD SOUTH WEST AFRICA ITALY JAVNA SIERRA LEONE WINDWARD ISLANDS CANADA MALTA

MUSCAT & OMAN FRANCE DENMARK GAMBIA AUSTRALIA HONG KONG NAURU GERMANY TUNISIA LUXEMBOURG NIGERIA FINLAND SOUTH AFRICA CZECHOSLOVAKIA

T20 + 20 AND T30 + 30 20W, 30W AMPLIFIERS



Designed by Texas engineers and described in Practical Wireless, the T20 was an immediate success. Now developed further in our laboratories to include a Toroidal transformer and additional improvements, the T20 + 20 delivers 20W rms per channel of true Hi-Fi, at exceptionally low cost. The easy to build design is based on a single Fibreglass PCB and features all the normal facilities found on quality amplifiers including scratch and tumble filters, adaptable input selector and headphones socket. In a follow-up article in Practical Wireless further modifications were suggested and these have been incorporated into the T30 + 30. These include RF interference filters and a tape monitor facility. Power output of this model is 30W rms per channel.

Pack	T20	T30
1. Set of low noise resistors	£1.60	£1.70
2. Set of small capacitors	£2.60	£3.40
3. Set of power supply capacitors	£2.20	£2.50
4. Set of miscellaneous parts	£3.50	£3.50
5. Set of slide, mains, P.B. switches	£1.50	£1.50
6. Set of pots, selector switch	£2.80	£2.80
7. Set of semiconductors, ICs, skts.	£7.25	£7.75
8. Toroidal transformer—240V prim.	£5.60	£7.20
i.s. sheets		

Pack	T20	T30
9. Fibreglass PCB	£3.50	£3.90
10. Set of metalwork, fixing parts	£5.20	£6.20
11. Set of cables, mains lead	£0.40	£0.40
12. Handbook	£0.25	£0.25
13. Teak cabinet 15.4" x 6.7" x 2.3"	£4.50	£4.50

One each of Pack 1-13 are required for complete stereo amplifier. Total cost of individually purchased packs T20 + 20 £40.90, T30 + 30 £46.60.

SPECIAL PRICES FOR COMPLETE KITS

T20 + 20 KIT PRICE **£33.10** T30 + 30 KIT PRICE **£38.40**

WWII TUNER



Following the success of our Wireless World FM Tuner Kit this cost reduced model was designed to complement the T20 + 20 and T30 + 30 amplifiers and the cabinet size, front panel format and electrical characteristics make this tuner compatible with either. The frequency meter of the more advanced model has been omitted and the mechanics simplified, however the circuitry is identical and this kit offers most outstanding value for money. Facilities included are switchable a.f.c., adjustable, switchable muting, LED tuning indication and both continuous and push-button channel selection (freely adjusted by controls on the front panel).

SPECIAL PRICE FOR COMPLETE KIT **£47.70** AVAILABLE AS SEPARATE PACKS — PRICES IN OUR FREE CATALOGUE

POWERTRAN SFMT TUNER



The requirement was a simple, low cost design which could be constructed easily without special alignment equipment but which still gives a first class output suitable for feeding any of our very popular amplifiers or any other high quality audio equipment. Not finding a suitable published circuit, the requirement was met by design and development work in our own laboratories and this tuner, which uses a pre-aligned front end module can be set up with the aid of nothing more sophisticated than a multi-meter. A phase-locked-loop is used for stereo decoding and controls include switchable a.f.c., switchable muting and push-button channel selection (adjustable by controls on the front panel). This unit matches well with the T20 + 20 and T30 + 30 amplifiers.

PRICE FOR COMPLETE KIT **£35.90** AVAILABLE AS COMPLETE KIT ONLY

Wireless World Amplifier Designs. Full kits are not available for these projects but component packs and PCBs are stocked for the highly regarded Bailey and 20W class AB stereo-tuned designs, together with an efficient regulated power supply of our own design. Suitable for driving these amplifiers is the Bailey Burrows 600 amplifier and our circuit board, for the stereo version it features 6 inputs, scratch and tumble filters and wide range tone controls, which may be either rotary or slider operating. For tape systems a set of three PCBs have been prepared for the integrated circuit based, high performance stereo Stuart design. Details of component packs are in our free Catalogue.

30W Bailey Amplifier	£1.00
BAIL Pk. 1 Fib. Glass PCB	£2.35
BAIL Pk. 2 Resistors, Capacitors, Potentiometer set	£4.70
BAIL Pk. 3 Semiconductor set	
20W Linsley-Hood Class AB	
LHAB Pk. 1 Fib. Glass PCB	£1.05
LHAB Pk. 2 Resistor, Capacitor, Potentiometer set	£3.20
LHAB Pk. 3 Semiconductor set	£3.35
Regulator Power Supply	
RDVS Pk. 1 Fib. Glass PCB	£0.85
RDVS Pk. 2 Resistor, Capacitor set	£2.20
RDVS Pk. 3 Semiconductor set	£3.10
RDVS Pk. 5A Toroidal transformer (for use with Bailey)	£8.80
RDVS Pk. 5B Toroidal transformer (for use with 20W LH)	£7.25
Stuart Burrows Stereo Pre-Amp	
SBPA Pk. 1 Fib. Glass PCB (stereo)	£2.80
SBPA Pk. 2 Resistor, Capacitor, Semiconductor (stereo)	£6.70
SBPA Pk. 3R Rotary Potentiometer set (stereo)	£2.85
SBPA Pk. 3S Slider Potentiometer set with knobs (stereo)	£3.10
Stuart Tape Recorder	
THTR Pk. 1 Relay Amp Fib. Glass PCB (stereo)	£1.30
THTR Pk. 1 Record Arm Fib. Glass PCB (stereo)	£1.70
THTR Pk. 1 Bias Erase Stabilizer Fib. Glass PCB (stereo)	£1.20

SQ QUADRAPHONIC DECODERS

These state-of-the-art circuits described by CBS and offered as kits of highest quality with close tolerance capacitors, metal oxide resistors and Fibreglass PCBs designed for edge connector insertion. Further information on these kits is given in our FREE CATALOGUE.

M1 Basic matrix decoder	£5.90
L1 Full logic decoder	£17.20
L2A Full logic decoder with variable bias	£22.50
L3A AS L2A but with high performance discrete component front end	£30.10
(with cassette film revision)	£25.90
SQM1 30 Decoder compatible with 30W four channel amplifiers. Complete kit matches T30 + 30 amplifier	£40.75

Value Added Tax not included in prices UK Carriage FREE

PRICE STABILITY: Order with confidence. Irrespective of any price changes we will honour all prices in this advertisement until March 31st 1978. If this month's advertisement is mentioned with your order. Errors and VAT changes excluded.

U.K. ORDERS: Subject to 12% surcharge for VAT (i.e. add % to the price). No charge is made for carriage, for at current rate if changed.

SECURICOR DELIVERY: For this optional service (U.K. mainland only) add £2.50 (VAT inclusive) per kit.

SALES COUNTER: If you prefer to collect your kit from the factory, call at Sales Counter (at rear of factory). Open 9 a.m.-4.30 p.m. Monday-Thursday.

SEMICONDUCTORS as used in our range of quality audio equipment

2N669	£0.20	8C107	£0.10	8F25A	£0.40	MPSA08	£0.25	TIP30C	£0.60
2N3055	£0.45	8C108	£0.10	8F25B	£0.47	MPSA12	£0.35	TIP31A	£0.70
2N3442	£1.20	8C109	£0.10	8FR39	£0.30	MPSA55	£0.25	TIP32A	£0.80
2N3711	£0.08	8C109C	£0.12	8FR39	£0.30	MPSA85	£0.35	TIP31B	£0.75
2N3904	£0.17	8C122	£0.15	8F851	£0.20	MPSA30B	£0.40	TIP32B	£0.90
2N3906	£0.20	8C136	£0.15	8F852	£0.20	MPSU05	£0.50	1N914	£0.07
2N5087	£0.25	8C182	£0.10	CA3045	£0.70	SBA750A	£1.90	1N916	£0.07
2N5089	£0.25	8C212	£0.12	LM301AN	£0.55	3X01	£1.30	5420	£0.10
2H5497	£0.45	8C82L	£0.10	LP1185	£6.50	SL3045	£1.20		
2N5459	£0.45	8C164L	£0.11	MC7310	£2.20	SN7213V	£0.40		
2N5460	£0.50	8C212L	£0.12	MC1351	£1.05	SN7214B	£0.40		
2N5481	£0.50	8C214L	£0.14	MC1747B	£0.65	STCR53	£2.40		
2N5830	£0.35	8C272	£0.13	MFC1010	£0.95	TL209	£0.20		
40361	£0.40	8D529	£0.65	MJ481	£1.20	TIP29A	£0.40		
40362	£0.45	8D530	£0.95	MJ491	£1.45	TIP30A	£0.45		
74004	£0.35	8D535	£1.60	MJ5521	£0.60	8F25C	£0.55		

FILTERS	
EM1	£1.00
SP10 TMA	£1.50

NEW PROJECTS

LINSEY-HOOD LOW DISTORTION OSCILLATOR

A Wien bridge audio oscillator (10Hz-100KHz) with sine or square wave output (1mV-1V) published in Wireless World September, October 1977.

Pack 1 Fibreglass PCB	£1.65
Pack 2 Capacitors, 2% metal oxide resistors	£2.60
Pack 3 Transistors, IC, IC socket, thermister	£3.90
Pack 4 Potentiometers and switches	£2.80

ERIC F. TAYLOR PRE-AMPLIFIER

A low noise low distortion (0.005%) stereo pre-amplifier for use with magnetic pick-up (RIAA equalization).

Pack 1 Fibreglass PCB (Stereo)	£1.45
Pack 2 Metal oxide resistors, capacitors (Stereo)	£3.20
Pack 3 Transistors, ICs, IC sockets, zeners (Stereo)	£4.20

For further details of these please ask for our NEW PROJECTS LIST

QUALITY: All components are brand new, first grade (full specification guaranteed) devices. All resistors (except where stated as metal oxide) are low noise carbon film types. All printed circuit boards are fibreglass, drilled roller milled and supplied with circuit diagrams and construction layouts.

AFTER-SALES BACK-UP: Servicing facilities (very rarely required for our kits) are available for all complete kits. Further details will be sent on request.

FOR FURTHER INFORMATION PLEASE WRITE OR TELEPHONE FOR OUR FREE CATALOGUE

DEPT WW2

POWERTRAN ELECTRONICS

PORTWAY INDUSTRIAL ESTATE
ANDOVER, HANTS SP10 3NN

ANDOVER
64455

AUDIO KITS OF DISTINCTION FROM POWERTRAN

NEW! DE LUXE EASY TO BUILD LINSLEY-HOOD 75W AMPLIFIER



**

Available as
Separate PacksDetails in
Free Catalogue

SPECIAL PRICE FOR COMPLETE KIT £99.30

The standard model of our Hi-Fi Mr. Linsley-Hood's 75W with custom bakelite tuning knobs offered exceptional performance for a very modest cost just made its price for unbeatable high quality, high power ready built unit. Features of the amplifier include very low distortion (less than 0.01%), 75W rms per channel power output, complete filter, variable slope screen filter, variable transition frequency tone controls, also including facilities and individually adjustable inputs. This model is based on 5 circuit boards which are having the controls mounted on their own, if desired, be effectively sold separately in high performance audio systems not based on our kitwork. Our new De Luxe model uses 18 boards when interconnect with gold plated contacts and have the potentiometers and switches fitted to them. There are 2 boards for each power module, 1 board for the pre-amp and 2 boards for the stereo pre-amplifier. This system almost eliminates internal wiring, making construction delightfully straightforward, and as each board can be easily removed, it is seconds from the chassis. Checking and maintenance is so simple that even newcomers to electronics will be able to cope competently with the set. Additional features of our new model are inclusion of tested circuit improvements, gold plated audio contacts for heavy duty use, even in tropical climates and metal oxide resistors throughout for long term stability and reliability.

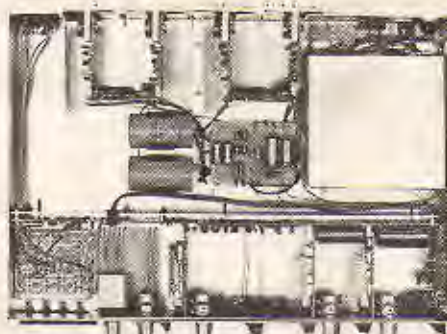

Internal view of De Luxe Kit

PACK PRICES FOR STANDARD KIT

Pack	Price	Pack	Price
1. Fibreglass printed circuit board for power amp	£1.15	11. Fibreglass printed-circuit board for power supply	£0.85
2. Set of resistors, capacitors, pre-sets for power amp	£2.50	12. Set of resistors, capacitors, secondary fuses, semiconductors for power supply	£3.40
3. Set of semiconductors for power amp	£6.50	13. Set of miscellaneous parts including DIN sockets, mains input skt., fuse holder, interconnecting cable, control knobs	£6.20
4. Pair of 2 drilled (lined heat sinks)	£1.10	14. Set of metalwork parts including silk screen printed fascia panel and all brackets, fixing parts, etc.	£0.20
5. Fibreglass printed circuit board for pre-amp	£1.90	15. Handbook	£0.30
6. Set of low noise resistors, capacitors, pre-sets for pre-amp	£4.10	16. Teak cabinet 18.3" x 12.7" x 3.1"	£10.70
7. Set of low noise, high gain semiconductors for pre-amp	£2.40		
8. Set of potentiometers (including mains switch)	£3.50		
9. Set of 4 push-button switches, rotary mode switch	£5.40		
10. Toroidal transformer complete with magnetic screen/ housing primary: 0 117-234 V secondaries: 33-0-33 V, 25-0-25 V	£10.95		

2 each of packs 1-7, 1 each of packs 8-16 inclusive are required for complete stereo amplifier. Total cost of individually purchased packs £90.80

LINSLEY-HOOD CASSETTE DECK

**



SPECIAL PRICE FOR COMPLETE KIT £79.60

Published in Wireless World (May, June, August 1976) by Mr. Linsley Hood, this design, although straightforward and relatively low cost, nevertheless provides a very high standard of performance. To permit circuit optimization separate record and replay amplifiers are used, the latter using a discrete component front-end designed such that the noise level is below that of the tape background. Push button switches are used to provide a choice at equalization time constants, a choice of bias levels and also an option of using an additional pre-amplifier for microphone use. The mechanism used is the Goldring-Lenco CRV, a unit distinguished in its robustness and ease of operation. Speed control and automatic cassette ejection are both implemented by electronic circuitry. This unit which is powered by a toroidal transformer and uses metal oxide resistors throughout offers an excellent match for the Wireless World Tuner and the Linsley-Hood 75 Watt Amplifier.

Pack	Price
1. Stereo PCB (accommodates 2 rep. amps, 2 meter amps, bias/erase etc. relay)	£3.95
2. Stereo set of capacitors, M.C. resistors, potentiometers for above	£7.90
3. Stereo set of semiconductors for above	£6.50
4. Miniature relay with socket	£2.90
5. PCB, all components for solenoid, speed control circuit	£3.80
6. Goldring-Lenco mechanism as specified	£16.50
7. Facetone switch, knobs	£1.90
8. Dual VU meter with illuminating lamp	£6.95
9. Toroidal transformer with E.S. screen yfm, 0-117V, 234V, Sec. 15V	£4.90

Pack	Price
10. Set of capacitors, rectifiers, I.C. voltage regulator for power supply (Powertran design)	£2.80
11. Set of miscellaneous parts, including sockets, fuse holder, fuses, interconnecting wire, etc.	£3.40
12. Set of metalwork including silk screened fascia panel, internal screen, fixing parts, etc.	£7.10
13. Construction notes	£0.25
14. Teak cabinet 18.3" x 12.7" x 3.1"	£10.70

One each of packs 1-14 inclusive are required for complete stereo cassette deck. Total cost of individually purchased packs £83.00

WIRELESS WORLD FM TUNER

**



SPECIAL PRICE FOR COMPLETE KIT £70.20

Designed in response to demand for a tuner to complement the world-wide acclaimed Linsley-Hood 75W Amplifier, this kit provides the perfect match. The Wireless World (Skingley and Thompson) published original circuit has been developed further for inclusion into this outstanding all-in-one unit and features a pre-aligned front end module, excellent m. rejection and temperature compensated varicap tuning, which may be controlled either continuously or by push-button pre selection. Frequencies are indicated by a frequency meter and sliding LED indicators, attached to each channel selector pre-set. The PLL stereo decoder incorporates active filters for 'birdy' suppression and power is supplied via a toroidal transformer and integrated regulator. For long term stability metal oxide resistors are used throughout.

Pack	Price
1. Fibreglass printed board for front end F. strip, demodulator, AFC and mute circuits	£2.15
2. Set of metal oxide resistors, thermistor, capacitors, ceramic preset for mounting on Pack 1	£4.80
3. Set of transistors, diodes, LED, integrated circuits for mounting on Pack 1	£5.25
4. Pre-aligned front end module, coil assembly, three section ceramic filter	£8.50
5. Fibreglass printed circuit board for stereo decoder	£1.10
6. Set of metal oxide resistors, capacitors, ceramic preset for decoder	£2.60
7. Set of transistors LED, integrated circuit for decoder	£2.90
8. Set of components for channel selector switch module including fibreglass printed circuit board, push-button switches, knobs, LEDs, preset adjusters, etc.	£9.40
9. Function switch, 10 turn tuning potentiometer, knobs	£5.80

Pack	Price
10. Frequency meter, motor drive components, fibreglass printed circuit board	£10.35
11. Toroidal transformer with electrostatic screen, Primary: 0-117V 234V, secondary: 15V	£4.90
12. Set of capacitors, rectifiers, voltage regulator for power supply	£2.10
13. Set of miscellaneous parts, including sockets, fuse holder, fuses, inter-connecting wire, etc.	£2.05
14. Set of metalwork parts including silk screen printed fascia panel, acrylic silk screen printed lining indicator panel insert, internal screen, fixing parts, etc.	£8.30
15. Construction notes	£0.25
16. Teak cabinet 18.3" x 12.7" x 3.1"	£10.70

One each of packs 1-16 inclusive are required for complete stereo FM tuner. Total cost of individually purchased packs £81.15

EXPORT A SPECIALITY!

Our Export Department can readily despatch orders of any size to any country in the world. Some of the countries to which we sent kits last year are shown in this advertisement. To assist in estimating postal costs our catalogue gives the weights of all packs and kits. This will be sent free on request, by airmail, together with our 'Export Postal Guide' which gives current postage prices.

EXPORT ORDERS: No minimum order charge! Prices same as for U.K. customers but no Value Added Tax charged. Postage charged at actual cost plus 50p documentation and handling. Please send payment with order by Bank Draft, Postal Order, International Money Order or cheque drawn on an account in the U.K. Alternatively for orders over £500 we will accept Irrevocable Letter of Credit payable at sight in London.

OUR CATALOGUE IS FREE!

JUST SEND YOUR NAME AND ADDRESS TO RECEIVE YOURS

Get a great deal from Marshall's

A. MARSHALL (LONDON) LTD., Dept. W.W., LONDON — 40-42 Cricklewood Broadway, NW2 3ET
Tel: 01-452 0161/2. Telex: 21492

LONDON — 325 Edgware Road, W2. Tel: 01-723 4242/3

GLASGOW — 85 West Regent St., G2 2OD. Tel: 041-332 4133

BRISTOL — 1 Straits Parade, Fishponds Rd., BS16 2LX
Tel: 0272 654201

Open 9.30 Mon-Fri, 9.5-10 Sat. Trade and Cash orders only.

NEW CATALOGUE 77

2nd edition for Autumn with over 8,000 line items. Plenty of new products and ideas. 35p post paid (25p to callers)

Our range covers over 8,000 items. The largest selection in Britain. Top 200 ICs, TTL, CMOS & LINEARS.

CA3020A 2.29	LM3874 1.05	SN76023N 2.20	78A5000 2.30	CD4002 1.10	7407 0.67
CA3020A 1.01	LM3886 0.90	SN76023K 1.50	78A510 2.21	CD4003 0.69	8970246 1.36
CA3020B 1.29	LM3887 1.00	SN76023L 1.30	78A5100 2.30	CD4004 0.64	8970247 1.36
CA3031 1.35	LM702C 0.75	SN76013ND 1.80	78A520 2.21	CD4011 0.24	RECTIFIERS
CA3032 1.10	LM703C 0.65	SN76013K 1.48	78A5200 2.30	CD4012 0.24	MM10500 0.48
CA3045 1.40	LM709K 0.45	SN76023N 1.45	78A530 1.98	CD4013 0.60	PW005 0.84
CA3046 0.88	LM710C 0.60	SN76023ND 1.28	78A5300 2.07	CD4014 1.15	PW01 0.88
CA3048 2.23	LM723C 0.85	SN76033N 2.20	78A540 2.21	CD4015 1.15	PW02 0.88
CA3049 1.80	LM723C 0.85	SN7611CN 1.18	78A540A 2.30	CD4016 0.64	PW04 0.98
CA3052 1.82	LM725N 0.75	SN76115N 1.51	78A550 3.13	CD4017 1.15	PW08 1.18
CA3053 0.70	LM741C 0.55	SN76116N 1.66	78A560 3.22	DIL SOCKETS	K005 2.10
CA3054 0.65	LM741N 0.40	SN76117N 1.20	78A5600 3.22	8 pin	K01 2.16
CA3058A 1.48	LM747A 0.40	SN76226N 1.66	78A570 1.29	14 pin	K02 2.48
CA3058 0.60	LM747CN 0.90	SN76227N 1.20	78A5700 1.38	18 pin	K04 3.12
CA3058 1.70	LM748A 0.55	SN76270N 1.41	78A571 2.20	22 pin	K05 3.88
CA3059 4.52	LM748N 0.55	SN78300N 0.75	78A571 2.20	22 pin	BY164 0.57
CA3090 4.00	LM1800 1.76	SN78382N 1.40	78A7000 1.61	28 pin	
CA3130 0.88	LM1808 1.92	SN78533N 1.20	78A7020 2.30	40 pin	
LM307A 0.67	LM1829 1.76	SN78544N 1.44	78A750 1.98	TRIACS	
LM307N 0.40	LM3207N 0.85	SN78545N 1.85	78A7500 2.07	Plastic	
LM304 2.45	LM3401N 0.70	SN78550N 0.35	78A800 1.25	400V 6A 0.70	
LM307N 0.65	LM3401N 0.70	SN78550N 0.35	78A810 1.25	400V 8A 0.75	
LM308N 0.85	LM3900 0.75	SN78552N 0.52	78A820 1.25	400V 12A 0.88	
LM309K 1.85	LM3906 1.60	SN78557N 1.65	78A820 1.25	400V 16A 1.10	
LM317K 3.00	LM3908 0.88	SN78562N 0.90	78A820 1.25	400V 20A 1.30	
LM318N 2.26	MC1305 1.75	SN78563N 1.10	78A840 1.60	400V 25A 1.70	
LM323K 6.45	MC1307P 1.54	SN78580N 0.80	78A840 1.60	400V 25A 2.00	
LM338N 1.40	MC1330P 1.00	SN78586N 0.92	78A1600 1.85	THYRISTORS	
LM348N 1.50	MC1350P 0.90	TA4310A 1.00	78A1600 1.85	1.61	
LM360N 2.75	MC1352P 1.10	TA4320A 1.00	78A276 2.25	100V 4A 0.35	
LM370N 2.60	MC1433G 3.30	TA4521 1.00	78A280A 1.30	200V 4A 0.40	
MC111H 1.70	MC1435G 2.00	TA4522 1.90	78A280A 1.30	300V 4A 0.44	
MC132N 1.70	MC1437P 2.00	TA4550 0.90	78A290A 1.84	400V 4A 0.49	
MC133N 2.80	MC1439N 1.60	TA4570 2.20	78A300 3.22	100V 8A 0.43	
MC1374N 3.10	MC1449G 1.70	TA4611B 1.85	78A370 2.76	200V 8A 0.49	
MC1377N 1.70	MC1455G 1.70	TA4611B 1.85	78A370 2.76	300V 8A 0.56	
MC1378N 2.25	NE555 0.40	TA4621 2.15	78A400 1.38	400V 8A 0.62	
MC1379N 3.95	NE555 1.10	TA4681S 1.50	78A400 1.38	600V 8A 0.74	
MC1380N 0.90	NE560 1.30	TA4700 3.91	78A4170 2.00	100V 12A 0.57	
MC1380N 0.98	NE560 1.85	TA4930A 1.30	78A4180 2.00	200V 12A 0.85	
MC1381N 2.45	NE567 1.80	TA4930B 1.30	CD4000 0.24	300V 12A 0.73	
MC1381N 1.60	NE567 2.50	TA4930C 1.95	CD4001 0.24	400V 12A 0.81	
MC1382N 1.75	NE567 2.50	TA4930D 1.95	CD4002 0.24	600V 12A 0.97	
MC1384N 1.45	SO42P 1.26	TA4940 2.00	CD4003 0.24	70V 4A 0.32	
MC1388N 0.80	SN7500N1.30	TA5000 2.21	CD4007 0.24	70V 4A 0.48	

POPULAR SEMICONDUCTORS (A very small selection from our vast stocks, please enquire about devices not listed.)

AP139 0.69	2N698 0.62	2N2923 0.14	2N3684 0.16	2N3696 0.22	2N5457 0.37
AP139 0.65	2N705 0.28	2N2924 0.15	2N3687 0.23	2N3697 0.25	2N5458 0.33
AP139 1.20	2N718 0.27	2N2926 0.15	2N3688 0.28	2N4058 0.20	2N5460 0.28
AS765 0.50	2N914 0.35	2N2927 0.15	2N3702 0.13	2N4060 0.20	2N5462 0.35
SC118 0.20	2N929 0.26	2N3019 0.55	2N3703 0.15	2N4122 0.26	2N5463 0.30
SC154 0.27	2N930 0.28	2N3053 0.26	2N3704 0.15	2N4123 0.17	40332 1.50
SC167A 0.12	2N1132 0.37	2N3055 0.70	2N3705 0.15	2N4126 0.17	40311 0.50
SC167B 0.12	2N1483 1.70	2N3108 0.80	2N3706 0.16	2N4250 0.24	40363 1.65
SC1698 0.12	2N1613 0.30	2N3135 0.45	2N3707 0.18	2N4266 0.20	40625 0.75
SC1718 0.16	2N1711 0.30	2N3392 0.16	2N3708 0.13	2N4284 0.35	40126 0.45
SC182 0.11	2N1893 0.38	2N3393 0.15	2N3709 0.15	2N4286 0.20	40127 0.45
SC182L 0.14	2N2090 0.50	2N3477 0.40	2N3710 0.16	2N4288 0.20	40152 0.50
SC1831 0.14	2N2219 0.35	2N4339 0.38	2N3711 0.16	2N4303 0.18	40153 0.55
MC172A 0.14	2N2221 0.25	2N4341 0.85	2N3712 0.16	2N4322 0.75	40187X 0.60
MC1741 0.17	2N2222 0.25	2N4353 2.99	2N3713 0.20	2N4315 0.20	40188K 0.60
BD133 0.37	2N2224 0.25	2N4355 0.20	2N3714 0.20	2N4320 0.20	40222 0.60
BF155 0.15	2N2368 0.25	2N4366 0.20	2N3719 0.36	2N4322 0.75	40238 0.80
BF184 0.36	2N2369 0.25	2N4367 0.20	2N3844 0.25	2N4322 0.18	40106 0.55
SF151 0.28	2N2948 0.75	2N4371 3.70	2N3856A 0.25	2N4345 0.34	40109 0.75
2N693 0.30	2N2905 0.37	2N4372 3.80	2N3858A 0.25	2N4447 0.15	40115 0.60
	2N2906 0.28	2N3698 0.16	2N3905 0.22	2N4449 0.19	

SPECIALIST CONSUMER NEW CATALOGUE

Shipping Distributors Officially Appointed

- NATIONAL
- TEXAS
- MULLARD
- SIEMENS
- SECOSEM
- VERO
- ANTEK
- ELECTROLUBE
- SIFAM
- ARROW HART

MAKES COMPONENTS BUYING EASY

ORDER NOW!

35p Post Paid or 25p To Callers. LARGE 32 PAGES packed with over 8500 LINE ITEMS



WHY NOT PAY US A VISIT AT OUR NEW CENTRAL LONDON BRANCH AT 325 EDGWARE ROAD, W2, ABOUT 100 YARDS NORTH OF THE WESTWAY FLYOVER. EXTENSIVE STOCK RANGE. MANY SPECIAL OFFERS TO PERSONAL SHOPPERS ONLY.

Prices correct 24 Nov. 1977, but please add VAT, p&g 40p

- TRANSISTORISED 3cm RADAR AMPLIFIER SWITCH:** with 24v waveguide switch, 1/8 x 4 cm ins. with crystal CV.2355 and spark gap VX.1046. £16.20 + £1.00 post.
- TRANSISTORISED VIDEO INDICATOR** (used with above amplifier): 1 1/2" C.R.T. £10.80 + £1.00 post.
- VACUUM & PRESSURE SEAL TEST EQUIPMENT:** Complete with 3 x 4" gauges indicating 0-20lbs p.s.i., 0-30lbs vacuum. With stand, hand pump, etc., £32.40 + £3.00 carr.
- INSULATION TEST SET 0 to 10 KV,** negative earth, with Ionisation Amplifier, 100/230 Volts, AC £45.90, carr. £3.00.
- RACAL RA-17 RECEIVER 500KHz-30mHz,** s/hand, good condition, £365.00 (including VAT 12 1/2%).
- AVO TRANSISTOR ANALYSER CT.446:** £37.80, carr. £2.20.
- MARCONI FREQUENCY METER 1026/4:** 2000-4000mHz 'as new' condition, £32.40 or secondhand condition £24.30.
- 1026/2:** 100-160mHz £32.40 'as new' or s/hand £24.30. Carriage for all type £2.00.
- BURGLAR ALARM BELL:** 6-8v. d.c. £3.24 + £1.00 post.
- MUIRHEAD ATTENUATORS:** 75 ohms 0-8Mc/s 3V MAK 3 ranges 0-5, 0-25, 0-50dB, £3.24 + 75p post.
- TELEPRINTER TYPE 7B:** Pageprinter 24v. d.c. power supply, speed 30 bauds per min. S/hand cond. (excellent), no parts broken £21.60, carriage £3.50.
- AUTO TRANSFORMER:** 230v, 50c/s, 1000 watts. Mounted in strong steel case 5" x 8 1/2" x 7". Bitumen impregnated. £12.96, carr. £2.00.
- CRYSTAL TEST SET TYPE 183:** Used for checking crystals in freq. range 3,000-10,000kHz. Mains 230v 50hz. Measures crystal current under oscillatory conditions and the equivalent resistance. Crystal freq. can be tested in conjunction with a freq. meter, £27.00, carr. £2.00.
- CATHODE RAY TUBES:** 5" screen, tube CV-1536 £4.32 + £1.00 post. Type 95J20 square face 5" x 3" £8.10 + £1.00 post.
- WEATHERPLOTTER RECEIVING SET AN/GMH-5:** Facsimile reproducing system for weather maps. Further details on request, £459.00 (inc. 8% VAT).
- CLASS 'D' WAVEMETER NO: 1:** Crystal controlled heterodyne frequency meter covering 2-8mHz. Power supply 6v. d.c. Good s/hand cond. £9.20 + £2.00 carr.
- RING TOROIDAL DUST CORES:** Size 2 1/2" outside, 1 1/4" inside, 5/16" thick. Box of two £1.10 + 30p post.

- ROTARY INVERTERS TYPE PE-218E:** Input 24-28v. d.c. 80 amps, 4,800rpm. Output 115v. a.c. 13 amp 400 c/s. 1Ph. P.F.9 £21.60 + £3.00 carr.
- FREQUENCY METER BC-221:** 125-20,000kc/s complete with original calibration charts. Checked out, working order. £22.70 + £2.00 carr.
- RECTIFIER UNIT:** 200-250v. a.c. input, 24v. d.c. at 26 amps output continuous rating. £37.80, carr. £5.00.
- PAPER TAPE:** 1/2" roll (teleprinters, etc.) Box of ten rolls £1.50 + £1.00 post.
- CREED TELEPRINTER TABLE:** £25.00 + £5 carr.
- ATTENUATOR UNITS STC:** Impedance 75 ohms. Two different types: (A) Push button 0-0.9 decibels in steps of 0.1dB and (B) Push button 0-90 decibels in steps of 10dB. Both types price £5.40, post 70p.
- MARCONI SIGNAL GENERATOR 801/DS:** 10-480mHz. £318.80.
- ROTARY CONVERTER:** 24 volts d.c. input, 230 volts, 100 watts output. £27.50, carriage £4.00.
- SIEMENS POWER METER 1mw to 500mw,** 6 ranges 0-17dB 50 ohms. £85.00, carriage £3.00.
- RADIO TELETYPE TERMINAL SET SG1A** 115 volts a.c. £17.50, carriage £3.00.
- TELEGRAPH DISTORTION TEST SET TYPE SCBV** 230 volts a.c. £25.00, carriage £3.00.
- RESONATOR PERFORMANCE CT.424** 8.5 to 9.0 kmc/s 3cm. £75.00, post £2.00.
- ALUMINIUM TRIPOD** (extra strong) will support 50lb. Extends to 56in. £10.00, carriage £3.00.
- INVERTER** 24 volts d.c. input 400 cycles 1ph 6600 r.p.m. 200 volts peak. £7.50, £1.50 post.
- OXYGEN BOTTLE** 1800lb, w.p. £10.00, carriage £3.00.
- VOLTAGE REGULATOR** 120 volts 62 amps. £17.50 each or two for £32.50, carriage £4.00 each.

BARGAIN MAPS

Large stocks of unused U.S.A.F. surplus maps, weather charts, etc. including:-

- ONC-EI — U.K. in full and part N.W. Europe. Scale 1:1,000,000.
- JNC-9N — N. Europe, U.K., Scandinavia. Scale 1:2,000,000.
- JN-21N — Europe (Mediterranean). Scale 1:2,000,000.
- 512R: 58" x 42", colour. Many others. Please send S.A.E. for list.

Price each 70p (inc. p+g)

25 x Maps (either same type OR assorted) £10.00 + £1.00 p+g

10 x Maps (either same type OR assorted) £5.00 (inc. p+g)

Above prices include VAT at 8% (except where stated)
Carriage quotes given are for 50-mile radius of Herts.

Visit our new shop in Ware High Street (old A10) opposite Church, 100s of individual bargains for callers. If you wish to collect any of the above items please telephone prior to calling to avoid disappointment.

W. MILLS 3 & 3a BALDOCK STREET, WARE, HERTS. SG12 9DT
WARE 66312 (STD 0920)

TRAMPUS



A SEMICONDUCTOR POWERHOUSE
TRAMPUS ELECTRONICS LTD., 58-60 GROVE ROAD, WINDSOR, BERKS. SL4 1HS. TELEPHONE WINDSOR (07535) 54525. CALLERS WELCOME MON.-SAT. 9 A.M.-5 P.M.

Fast service on in-stock products, normally 24 hour turn-around. Quality devices to manufacturers specifications. Bargainday & Access by post or telephone. £5 minimum. Send £500. and 30p post & packing plus 8% VAT to items marked * 12% VAT to unmarked items. No minimum order charge for cheque or postal orders. Government stocks, specials, NMA 25 min. order. Price catalogue free list, send SAE. Money back on untested components. Cheques

Ref.	VA (Watts)	£	P&P
67*	20	4.40	75
145	80	6.20	96
150	100	7.13	1.14
151	200	11.16	1.50
152	250	12.79	1.84
153	350	16.28	1.84
154	500	19.15	2.15
155	750	29.06	OA
156	1000	37.20	OA
157	1500	45.60	OA
158	2000	54.80	OA
159	3000	79.05	OA

*115 or 240 sec only. State volts required.

TRANSFORMERS

ALL EX-STOCK — SAME-DAY DESPATCH
MAINS ISOLATING VAT 8% 12 and/or 24-VOLT
 Pri 120/240V SEC 120/240V
 Centre Tapped and Screened
 Separate 12V windings Pri 220-240V

Ref.	Amps	£	P&P
111	0.5	0.25	2.20
213	1.0	0.5	2.64
71	2	1	3.51
16	4	2	4.03
70	8	3	5.35
108	8	4	6.98
72	10	5	7.67
116	12	6	8.99
17	16	8	10.39
115	20	10	13.18
167	30	15	17.05
226	50	30	26.82

50 VOLT RANGE

Primary 220-240V
 SEC. TAPS 0-20-25-33-40-50V
 70 or 20V 25 or 25V available by connection to appropriate taps

Ref.	Amps	£	P&P
102	0.5	3.41	75
103	1.0	4.57	96
104	2.0	6.88	1.14
105	3.0	8.45	1.32
106	4.0	10.70	1.50
107	6.0	14.62	1.64
118	8.0	17.05	2.08
119	10.0	21.70	OA

30 VOLT RANGE

Primary 220-240V
 SEC. TAPS 0-12-15-20-24-30V
 120-12V or 150-15V available by connection to appropriate taps

Ref.	Amps	£	P&P
112	0.5	2.64	78
79	1.0	3.57	96
3	2.0	5.27	96
20	3.0	6.20	1.14
21	4.0	7.44	1.14
51	5.0	8.37	1.32
117	6.0	9.92	1.45
88	8.0	11.73	1.64
89	10.0	13.33	1.84

60 VOLT RANGE

Primary 220-240V
 SEC TAPS 0-24-30-40-48-60V
 24-24V or 30-30V available by connection to appropriate taps

Ref.	Amps	£	P&P
124	0.5	3.88	96
126	1.0	5.58	96
127	2.0	7.60	1.14
128	3.0	10.54	1.32
123	4.0	12.23	1.84
40	5.0	13.95	1.64
120	6.0	15.66	1.84
121	8.0	20.15	OA
122	10.0	24.03	OA
189	12.0	27.13	OA

70 VOLT RANGE

Primary 220-240V
 SEC TAPS 0-24-30-40-48-60V
 24-24V or 30-30V available by connection to appropriate taps

Ref.	Amps	£	P&P
124	0.5	3.88	96
126	1.0	5.58	96
127	2.0	7.60	1.14
128	3.0	10.54	1.32
123	4.0	12.23	1.84
40	5.0	13.95	1.64
120	6.0	15.66	1.84
121	8.0	20.15	OA
122	10.0	24.03	OA
189	12.0	27.13	OA

SCREENED MINIATURES

Primary 240V

Ref.	mA	Volts	£	P&P
238	20	3-0-3	1.99	55
212	1A, 1A	0-6-0-6	2.85	78
13	100	3-0-3	2.14	38
235	350, 330	0-9-0-9	1.99	38
207	500, 500	0-9-0-9-0-9	2.59	71
208	1A, 1A	0-9-0-9-0-9	3.53	78
209	200, 200	0-15-0-15	1.99	38
259	50MA	12-0-12	1.99	38
214	300, 300	0-20-0-20	2.56	78
221	700(OC)	20-12-0-12-20	3.41	78
206	1A, 1A	0-15-20-0-15-20	4.63	95
203	500, 500	0-15-27-0-15-27	3.99	95
204	1A, 1A	0-15-27-0-15-27	5.39	96
S112	500	0-12-15-24-24-30	2.64	78

HIGH VOLTAGE

MAINS ISOLATING
 Pri 200/220 or 400/440
 Sec 100V/120 or 200/240

VA	Ref.	£	P&P
80	243	5.89	1.32
350	247	14.11	1.84
1000	250	35.85	OA
2000	252	54.25	OA

BRIDGE RECTIFIERS

200V	2A	45p
400V	2A	55p
200V	4A	65p
400V	4A	90p
400V	8A	£1.05
500V	10A+	£2.35

*P&P 15p. VAT 12½%
 *VAT 8%

TEST METERS

AVOB Mk. 5	£71.00
AVO71	£29.00
AVO73	£38.10
AVOMMS MINOR	£24.00
WEE MEGGER	£58.80
AVO TT189 (tests transformers in circuit, no soldering)	£30.00
U4315 budget meter 142 ranges) 20KΩ/VDC 1000V AC/DC (9 ranges) 2.5A AC/DC 500KΩ resistance. In robust steel case with leads, full instructions.	£14.95

Auto Cases and Accessories ex-stock
 P&P £1.15 VAT 8%

MINI-MULTIMETER

DC1000V, AC1000V
 AC/DC1000Ω/V
 DC100mA Res—150K
 Bargain at **£5.86**
 VAT 8% P&P 62p

PLASTIC CASES

PB1—77 x 56 x 37mm	.46p
PB2—95 x 71 x 35mm	.56p
PB3—115 x 95 x 37mm	.80p

n.p.o 29p. VAT 8%

STEREO F.M. TUNER

Phase lock loop, 4 pre-selected stations, varicap tuning, switched AFC Beacon
£20.45
 P&P 40p (VAT 12½%)

Special offers: Trans D12—Pri. 0-0-0, 110-200-220-240V Sec. 0-1-10V 0-20-24V 2.5A **£2.25**, P&P 45p

Barrie Electronics Ltd.

3, THE MINORIES, LONDON EC3N 1BJ
TELEPHONE: 01-488 3316/8
NEAREST TUBE STATIONS: ALDGATE & LIVERPOOL ST.

WW—069 FOR FURTHER DETAILS



Better instruments. Better service.

We have established a nationwide network of approved service organisations to deal with the repair and maintenance of our instruments. Every repair is backed by a full 12 month guarantee. Here's where to find them.

ENGLAND London Instrument Repair Centre, Acton Lane, Chiswick, London W4 5HJ. Trade Reception: Cunningham Street. Tel: 01-995 9212
 London Instrument Repair Centre, Archcliffe Road, Dover, Kent. Tel. Dover (0304) 202620
 Farnell International Instruments Ltd., Sandbeck Way, Wetherby, West Yorkshire LS22 4DH. Tel: Wetherby (09571) 3541
 T.F.R. Instruments Ltd., Peel Lane, Astley, Manchester M29 7JH. Tel: Atherton (05254) 2275 or 5611
 Midlands Instrument Repair Centre, Thom Automation Ltd., Armitage Road, Rugeley, Staffs. Tel: Rugeley (06894) 5151

SCOTLAND Falcon Electronics, 92 High Street, Johnstone, Scotland. Tel. Johnstone (0505) 23377

WALES Electro Services, 25 Chepstow Road, Newport, Gwent NPT 8BX. Tel: Newport (0633) 211243



The manufacturers' joint service organisation.
 WW—035 FOR FURTHER DETAILS

WW—047 FOR FULL DETAILS



YAESU MUSEN

FOR THE FINEST VALUE IN THE WORLD

THE FRG7 Synthesised General Coverage Communications Receiver



The FRG7 is a solid state mains and 12v. receiver offering continuous coverage 0.5—30 MHz with specifications unparalleled in its price range.

Its advanced circuitry provides superb performance for professional or amateur alike: search, monitor, test, amateur or broadcast band applications.

The use of a Wadley loop (using the same VHF oscillator to mix up, then after pre-mixing with a stable crystal source down again (this cancelling all drift from the variable oscillator). It provides equivalent performance to 30 crystal controlled converters (featuring a low IF, but without the image problems of such an arrangement).

The signal path starts with the choice of 3 antenna connectors: for 1.6-30 MHz, a 50/75 ohm feed (to a SO239 (UHF) coax socket and a binding post) and for 0.5-1.6 MHz (medium wave) a separate high impedance binding post. A 3 position 0-40dB switchable attenuator aids reception of very strong signals and reduces adjacent channel interference. The low noise MOSFET RF amplifier provides a SSB sensitivity of 0.25 μ V (for 10dB N+S/N at 10.5 MHz) and is sharply tuned by a well calibrated "pre-selector" capacitor with 4 band switched coils. Its output is low pass filtered ($f_c=35$ MHz) removing VHF image problems from the following mixer. This comprises a pair of JFETs, driven by the "MHz set" 55.5-84.5 MHz, oscillator, which upconverts the signal to the band pass first IF to 55 MHz \pm 500 KHz where it is MOSFET amplified. The second IF of 2-3 MHz is produced by a FET mixer by heterodyning with the synthesiser derived 52.5 MHz signal. A 1 MHz crystal oscillator and diode harmonic generator produces a 3-32 MHz comb spectrum. This, with the first heterodyne oscillator (MHz set) is fed to a dual balanced i.c. pre-mixer. The output is expurgated by a multiple stage selective amplifier producing the 52.5 MHz second oscillator. A small fraction of this is rectified, DC amplified and lights the "lock" LED (saving power) when the MHz oscillator is malset. The 2-3 MHz signal is MOSFET amplified and fed to the third mixer (a JFET whose input and output are tuned by capacitors ganged to the main tuning control) where it is heterodyned to the final IF by the main VFO which covers a 1 MHz range (2.455-3.455), is clearly calibrated, to 5 kHz (or better), well buffered and highly stable. The third (455 kHz) IF starts with the ceramic selectivity element and is followed by two stages of bipolar (the first in the signal path) amplification before the choice of detectors: twin diodes for AM, or a 4 diode product detector,

with well buffered switched frequency (for selectable sidebands) B.F.O. A diode rectifies, a fraction of the output from the final IFT, this is boosted to drive the illuminated "S" meter and automatically gain control the MOSFET amplifier in the RF, second and third IF stages, reducing fading and distortion. Immediately following the demodulator is an automatic noise limiter, highly effective in suppressing pulse type interference on AM signals, and a three position "tone" switch a (high, low or band pass) audio filter, reducing the bandwidth to that required. A transformerless AF amplifier delivers a generous 2W to the internal 5" x 3" or external speaker, drives a phone jack, and a "volume" independent output for tape recorder. The receiver is, mains (234VAC), external (12V DC) or internal dry cell powered, the most economic source being automatically chosen. This is reduced to a stable regulated 10v. (or 9v. for oscillator and the harmonic generator). A dial lamp switch is provided to conserve power on battery operation.

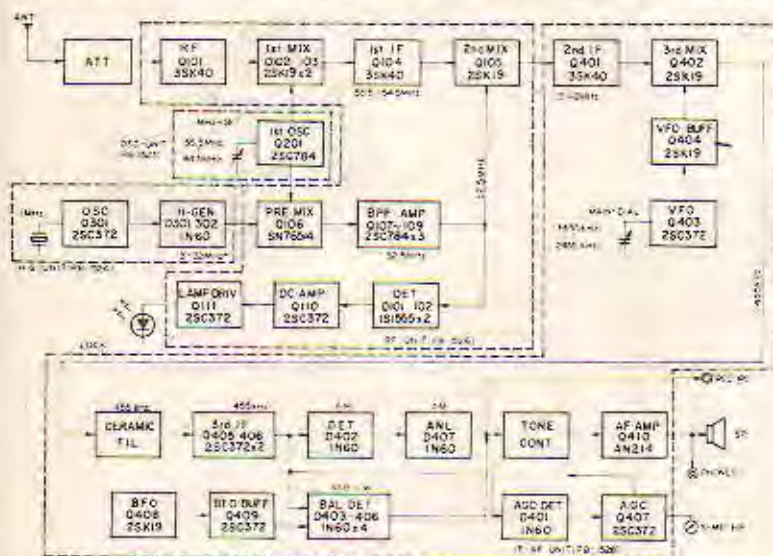

**PERFORMANCE WITH ECONOMY
WORLD WIDE WIRELESS**

CONSERVATIVE SPECIFICATIONS

FREQUENCY RANGE 0.5-30MHz

General coverage in 4 bands

AUDIO DISTORTION less than 10% at 2W output

AUDIO OUTPUT more than 2W

ANTENNA IMPEDANCE 50-75 ohms. Unbalanced for 1.6-30MHz. High impedance for 0.5-1.6MHz.

MODES SSB (selectable USB&LSB) AM, AM/ANL

or CW

CIRCUITRY 13 bipolar and 9 field effect transistors

2 ICs and 16 diodes

SIZE 13 1/2" W x 6" H x 11 1/2" D

POWER REQUIREMENTS 13.5V DC Neg.

ground or 8 off HP11 or 100/110/117/220/234V AC 50/60 Hz.

FREQUENCY STABILITY within 500Hz

during any 30 mins after warm up.

SELECTIVITY \pm 3KHz at 6dB (nominal) and

\pm 7KHz at -60dB down.

WEIGHT 15 1/2 lbs without batteries.

SENSITIVITY 0.25 μ V for 10dB N+S:N ratio for SSB and CW. 0.7 μ V for 30% modulated AM at 10.5 MHz.

OUR AGENTS

Amateur Electronics
508-514 Alum Rock Road
Alum Rock
Birmingham B8 3HX

South Midlands Communications Ltd.
S.M. House, Osborne Road
Totterton
Southampton, Hampshire SO4 4DN

Western Electronics (UK) Ltd.
Fairfield Estate
Louth
Lincolnshire LN11 0JH

WW-075 FOR FURTHER DETAILS

Magnum Modules

ENCAPSULATED HI-FI MODULES FOR THE DISCERNING ENTHUSIAST

MAGNUM BOARDS — FOR THE PROFESSIONAL TOUCH

Take a Magnum **CP-MC1** board, a **CP-P1** pre-amp module, one switch plus 4 pots and you have the basis of a quality pre-amp. Add a **CP-TM1** if you wish to monitor peak loads. For comprehensive Hi & Lo Filtering and control of stereo separation (Image Width) mount a **CP-FG1**. 2 switches and 3 pots on a Magnum **CP-MC2** board. A combination of these two gives 3mV sensitivity with >70db S/N ratio and >40db overload margin.

Distortion is a low 0.02%. Magnum boards aren't essential — just an easy way to build the Magnum system of your choice — you still retain all the options.

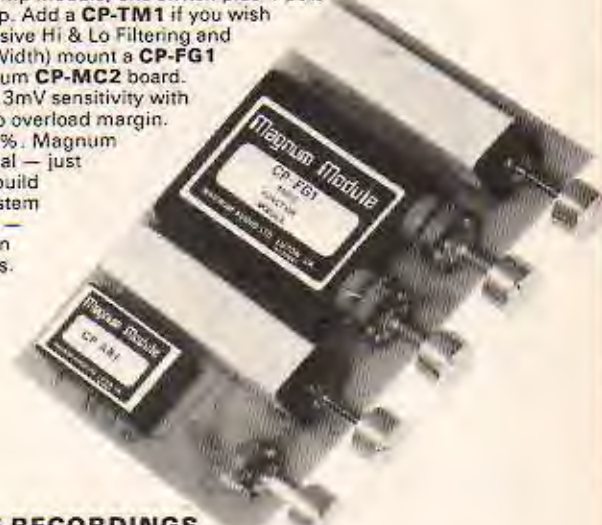
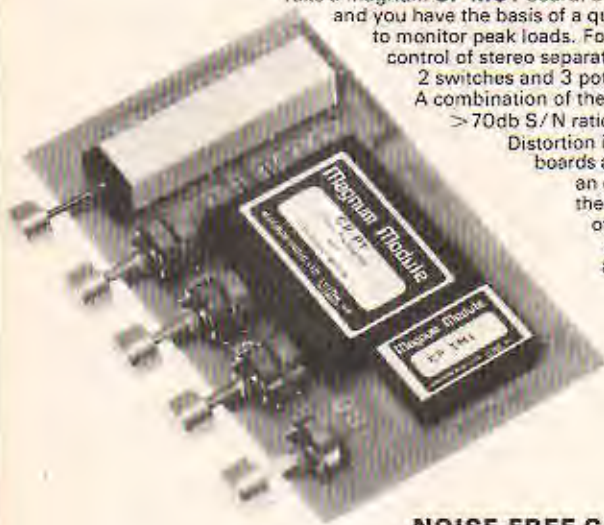

NOISE-FREE CASSETTE RECORDINGS

The limited dynamic range of most tape recorders, particularly cassette recorders, means noise over the quiet passages and clipping and distortion of peak levels. The **CP-DR1** lets you record almost double the dynamic range and recover the programme free of these defects.

It can also be used for dynamic range control to compensate for programme material and/or listening conditions.



ZERO-PHASE SPEAKERS

These active crossovers contribute zero phase error and are thus a 'must' for that ultimate speaker system. They are so easy to use (just 2 resistors to set each crossover point) that you may choose to use them instead of those chokes and capacitors. Try the **CP-LX1** in the WW Bookshelf speaker (Oct. 77 p.42).



15-40 WATT AMPLIFICATION

Each **CP2-15/20** heatsink contains two 15/20 watt amplifiers. One unit will give 15W/channel stereo into 8 Ohm (20W into 4 Ohm). Add another unit and you get 40W/channel.

These amplifiers are protected against overload and short circuit conditions and also feature thermal and reverse connection protection. Transient performance is virtually unaffected by loading and free from overshoot and TIM distortion. THD is typically <0.03% @ 1 KHz. All this adds up to a versatile and robust amplifier of extremely 'clean' and 'musical' performance.



Backed by first application data and information service, 2 year guarantee; fully inclusive prices (U.K.)

Send large SAE for details of all MAGNUM AUDIO MODULES

CP-P1 Stereo Pre-Amplifier	£14.96
CP-FG1 Audio Function Module	£13.22
CP-TM1 Peak Programme Monitor	£8.60
CP-DR1 Dynamic Range Controller/Tape Noise Eliminator	£41.40
CP-LX1 Single Point Linear Phase Active Crossover Network	£14.60
CP-LX1-P CP-LX1 set to your choice of frequency	£10.86
CP-LX2 Two Point Linear Phase Active Crossover Network	£14.60

Benelux Agent: I.A.T.A. p.v.b.a. Kerkstraat 16, B3020 Leuven-Wijgmaal, Belgium.

CP-LX2-P CP-LX2 set to your choice of frequencies	£16.29
CP2-15/20 Stereo Amplifier Module	£14.46
CP-AR1 Voltage Stabiliser Module	£7.57
CP-PS 18/20 Power Supply Module	£7.31
CP-MC1 Printed Circuit Board for CP-P1 and CP-TM1 (optional) and controls	£6.86
CP-MC2 Printed Circuit Board for CP-FG1 and CP-AR1 (optional) and controls	£6.75

Barclaycard and Access facilities available

MAGNUM AUDIO LTD.

DEPT. W2, 13 HAZELBURY CRESCENT
LUTON, BEDS, LU1 1DF. Tel. 0582-28887

Z & I AERO SERVICES LTD.

Head Office: 44A WESTBOURNE GROVE, LONDON W2 5SF
Tel.: 727 5641 Telex: 261306

RETAIL SHOP
85 TOTTENHAM COURT ROAD, W.1
Tel. 580 8403



R.C. OSCILLATOR G3-36A

Made in USSR

Portable transistorized R-C oscillator providing sinewave and 50/50 squarewave. Four separate output sockets give attenuation ratio of 1, 10, 100 and 1000. Output 0-5 volts R.M.S. Frequency range 20Hz-200KHz in four bands. Output impedance 600Ω for sinewave and 4000Ω for squarewave. Harmonic distortion 1-2%. Power supplies 200-240V AC.

Price **£37.00**
Packing and delivery **£2.00**
(VAT 8% to be added to the above figure)

TAUT SUSPENSION MULTIMETERS

Made in USSR



TYPE	U4313	U4315
Sensitivity D.C.	20,000 o.p.v.	20,000 o.p.v.
Sensitivity A.C.	2,000 o.p.v.	2,000 o.p.v.
D.C. Current	60μA-1.5A	50μA-2.5A
A.C. Current	0.6mA-1.5A	0.5mA-2.5A
D.C. Volts	75mV-600V	75mV-1000V
A.C. Volts	15V-600V	1V-1000V
Resistance	1K-1M	300Ω-500KΩ
Capacity	0.5μF	0.5μF
Accuracy	1.5% D.C. 2.5% A.C.	2.5% D.C. 4% A.C.

Price complete with pressed steel carrying case and test leads.
Packing and postage

£17.50 **£14.95**
£1.50 **£1.50**
Plus VAT at 8%

FULLY GUARANTEED



VALVES

0A2	0.55	6L6GT	0.80	6X5	0.60	6X8	2.80
0A3	0.75	6L6	0.55	6X4	0.50	6X5	0.50
0B2	0.60	6L6GT	0.65	6X5	0.50	6X5	0.63
0C3	0.75	6SL7GT	0.70	6X5	0.55	6X5	0.60
1B3GT	0.65	6SN7GT	0.70	6X5	1.50	6X5	0.70
1R5	0.50	12AT5	0.55	6X5	0.50	6X5	0.55
1X2B	1.20	12AQ5	0.55	6X5	0.50	6X5	0.70
5845Y	1.10	12AT5	0.60	6X5	0.50	6X5	0.70
5845	0.60	12AT7	0.50	6X5	4.50	6X5	0.75
5845B	0.95	12AU6	0.65	6X5	5.80	6X5	1.30
5V6	0.60	12AU7	0.47	6X5	0.85	6X5	1.80
5Y3GT	0.65	12AV6	0.85	6X5	0.85	6X5	7.80
5Z4GT	0.65	12AV7	1.00	6X5	0.85	6X5	0.58
6A4	0.55	12AX7	0.55	6X5	0.40	6X5	0.80
6A5	0.65	12AY7	0.85	6X5	0.40	6X5	0.70
6A5	0.55	12BA5	0.65	6X5	0.50	6X5	0.60
6AL5	0.40	12BE6	0.80	6X5	0.50	6X5	0.60
6AW6	0.70	12BH7	0.75	6X5	0.70	6X5	0.60
6AS5	0.75	12C4	0.50	6X5	0.90	6X5	0.60
6AS6	1.00	1940S	0.75	6X5	0.70	6X5	0.75
6AT6	0.75	3543	0.75	6X5	0.70	6X5	0.55
6AV6	0.75	35B5	0.65	6X5	1.20	6X5	0.75
6AW6A	0.75	35C5	0.70	6X5	0.95	6X5	0.65
6AU6	0.50	35W4	0.70	6X5	0.80	6X5	0.70
6AV6	0.75	30T5	1.00	6X5	0.65	6X5	0.75
6BA5	0.45	FA820	0.55	6X5	0.60	6X5	0.80
6BE6	0.48	FA72	0.70	6X5	0.60	6X5	0.80
6BE6	1.20	FA701	0.70	6X5	0.45	6X5	0.50
6EN6	0.80	EB01	0.75	6X5	0.75	6X5	0.50
6E25	0.65	EB01	0.70	6X5	0.80	6X5	0.50
6E27	0.70	EB01	0.50	6X5	0.80	6X5	0.80
6E4	0.55	EBK3	0.50	6X5	0.65	6X5	0.80
6E6	0.55	EBR8	0.45	6X5	0.65	6X5	0.80
6E06	2.20	EC85	0.75	6X5	0.60	6X5	0.80
6E43	0.70	EC85	0.75	6X5	0.50	6X5	0.80
6E46	0.90	ED1	2.80	6X5	0.60	6X5	0.80
6E4	1.20	ED24	0.60	6X5	0.60	6X5	0.80

All prices are exclusive of VAT

When ordering by post please add (unless otherwise indicated) 30p in £ for packing and postage, plus appropriate rate of VAT

Minimum order charge for approved credit customers is £20.00. Any order below £20.00 (before VAT) should be accompanied by remittance.

Minimum transaction charge for cash order, regardless of the value of goods is £1.00.

Our new 1978 Catalogue is now ready. Please send P.O. or stamps for 30p for your copy.

WW-070 FOR FURTHER DETAILS

EUROTECH

MISCELLANEOUS

J. Lloyd XY Plotter Type PL	£160
S. E. Labs. UV Recorder Type 3006DL	£600
Grubb Parsons Type IRG A20 Analyser	£480
6v 25 Amp. Power Supply Units	£25
D.M. Digital Voltmeter. Type 2022S	£240
Electro Scientific Industries Portametric PVB 300	£180
Stanley Lab. Counter Timer SL111	£100

OSCILLOSCOPES

TEKTRONIX

Type 551 with Power Supply	£300
Type 545A with 1A2 Dual Trace Amp	£485
Type 585 with Type 82 Dual Trace	£550
Type 581A with Type 82 Dual Trace	£550
Plug in Modules	
Type CA, G, H, L, K	£80 each
Type 3A75 Amp. 4MHZ	£80
3A8 Operational Amp	£75
3T77 and 3S76 Sampling	£250
82 Dual Trace Amp	£135
1A4 Four Trace Amplifier	£500

HEWLETT PACKARD

Type 180A with 1801A Dual Channel Vert Amp.
1820S Time Base **£650**

THE TEST EQUIPMENT BROKERS
EQUIPMENT SOLD, PURCHASED RENTED, LEASED
ALL PRICES EXCLUDE VAT AND CARRIAGE
TEL. NEWPORT 0633 211243.

EUROTECH
25 CHEPSTOW ROAD
NEWPORT, GWENT, U.K.

WW-025 FOR FURTHER DETAILS



Get up to date at IEA-ELECTREX

13-17th MARCH 1978

IEA-Electrex, the International Electrical, Electronic and Instrument Exhibition, which returns to the National Exhibition Centre, Birmingham, from 13-17 March 1978 following its most successful debut there in 1976, will be the first major event in its field in the European 1978 calendar.

IEA will have three impressive sections for electronic components, process control instruments and a general classification and will include professional and industrial electronics, active and passive components, process control and scientific instrumentation, machine tool control and automation, computer techniques and data handling.

ELECTREX will feature power production and transformation, power applications, transmission and distribution, safety and control equipment, emergency and stand-by plant, industrial and commercial lighting and installation equipment and components. Its sponsors are joined for the first time by the Lighting Industry Federation and a lighting section will be featured.

IPHEX, the International Pneumatics and Hydraulics Exhibition incorporating Compressors and Power Transmission Equipment, will be staged at the NEC concurrently with IEA Electrex.

The International Electrical,
Electronic and Instrument Exhibition.
National Exhibition Centre,
Birmingham, England.

IEA/ELECTREX

Please send me further details Registration cards

Name.....

Company.....

Address.....

WW1

Send to: Industrial & Trade Fairs Ltd, Rockliffe House, Blenheim Court, South West Midlands, B1 1RR, England

NEW! AMERICAN STYLE CRADLE TELEPHONE AMPLIFIER



ONLY
£14.95
+ VAT £1.20

Latest transistorised Telephone Amplifier is completely automatic with detachable plug-in speaker. Placing the receiver on to the cradle activates a switch for immediate two-way conversation without holding the hand-set. Many people can listen at a time. Increase efficiency in office, shop, workshop. Perfect for "conference" calls: leaves the user's hands free to make notes, consult files. No long waiting. On/Off switch, volume control. Model with tape recording facility £15.95 + VAT £1.36. P. & P. 89p. C.W.O. 10-day price refund guarantee.

WEST LONDON DIRECT SUPPLIES (W/W)
169 Kensington High Street, London W.8

NEW IMPROVED MAINS INTERCOM



NO CABLES
NO WIRES

ONLY
£29.99

per pair
+ VAT £3.75

Made to High Safety and Telecommunications Standards. The modern way of instant 2-way communications. Supplied with 3-core wire. Just plug into power socket. Ready for use. Crystal clear communications from office to office. Operates over 1/2-mile range on the same mains phase. On/off switch. Volume control. Useful as office intercom, garage and homes, between office and warehouse. Full price refund if returned in 10 days. **Six months' service guarantee.** P. & P. 89p.

STEREO DISC AMPLIFIER 2

FOR BROADCASTING, DISC MONITORING AND TRANSFER WITH THE HIGHEST QUALITY. Stereo Disc Amplifier 2 is a self-contained mains powered unit which accepts cartridge inputs and produces balanced line level outputs. Permanent rumble filtering and switched scratch filtering are included. 1KHz @ 6mV set for 0dBV. 7 output, loaded 600 ohms.

Total Harmonic Distortion

Output + 10dBV 7 30 Hz - 20KHz below noise

Output + 20dBV 7 1KHz-88dB, 0.004%; 30Hz-20KHz-82dB, 0.008%

Static Intermodulation Distortion 50Hz + 7KHz 4:1

Output + 10dBV 7 - 80dB, 0.003% limit of measurement

Dynamic Intermodulation Distortion 3.18KHz square wave (single pole) - 3dB @ 100KHz + 15KHz sine wave, 4:1 Relative to 15KHz component.

Pre-emphasised input 1V pk-pk - 70dB, 0.03% limit of measurement

Cartridge impedance interaction on frequency response.

High inductance cartridge, 1H Less than 0.2dB

Clipping Point Complementary to IIAA Curve, 1KHz disk at + 24dBV, 7 output

30Hz-20KHz Within 1dB

Clipping determined by onset of peaky distortion products or THD exceeding -80dB

Differential Phase Shift between left and right channels

50Hz-20KHz Within 0.5°

Worst error at LF and HF filter turnovers.

Within 5 1KHz - 76dB, 30Hz 20KHz - 60dB

Crosstalk

SURREY ELECTRONICS

The Forge, Luckis Green, Cranleigh, Surrey GU6 7BG (STD 04866) 5997

COMPUTER APPRECIATION

86 High Street, Bletchingley, Redhill, Surrey RH1 4PA. Tel: Godstone (0883) 843221

OLIVETTO Model 318 Teletype - compatible ASCII terminals. Complete ASR facility with tape reader/punch. Fully refurbished and with stand, etc. **£295.00.**

Also with correspondence-quality upper/lower case at + **£80.**

TELETYPE Model ASR 33 available now. **£425.00.** **KSR 35, £195.00.**

FLEXOWRITER ASR Typewriter terminals. **£100-£250.**

CASSETTYPER IBM Golfball with dual Philips cassette station. **£1225.00.**

COSSOR VDU Model 401 pw keyboard, memory, etc. but needs ext. clock. **£95.00.**

CASE Receive. Only VDUs with video monitor and VDU controller incl. 1024 character memory. Dated 7/77. **£75.00.**

ANNE ARBOR VDU, RS 232 to 9600 Baud, as new. **£275.00.**

SAGEM Electronic Teletypewriter, 7 unit code, 60-mA interface. **£45.00.**

REDIFON VDU controller, keyboard and case. **£85.00.**

FACIT 4021 300cps Tape Reader with TTL interface, as new. **£225.00.**

ICL Model 250 300cps Tape Reader. **£78.00.**

DATEK Model 40 40cps Tape Reader, brand new desk top unit. **£35.00.**

DATA DYNAMICS Model DD110 High Speed Punch in silencing cabinet. **£195.00.**

TELETYPE Model BRPE 110 High Speed Punch. **£95.00.**

SINGER 35cps Punch cw spooling, TTL interface, mains p.s.u. **£88.00.**

ICL Model 7020 High Speed Paper Tape Terminal with RS 232 interface switchable 600/1200 Baud. **£375.00.**

CASE Model 120 compact 120cps dot matrix PRINTER. ASCII coded, TTL interface. **£225.00.**

DIABLO Model 21 12 megabit disc unit. With p.s.u. and in bk demp. condition. **£345.00.**

DEC Model DF 32 Disc for PDP 8. **£275.00.**

MOHAWK MDS 1102 keyboard-to-magtape unit. **£95.00.**

PERTEC 6X40 7 track magtape unit. **£275.00.** Another, less electronics. **£125.00.**

HYTECH Model 8114 Data Logger. Compact unit with all electronics. **£85.00.**

GENERAL AUTOMATION SPC12 MINI with AK & TTY interface. **£85.00.**

AMD Am 2900 MICROPROCESSOR Evaluation Kit. **£65.00.**

MEMORY Cards 4K x 12 with TTL interface and all documentation. **£75.00.**

TEKTRONIX Model 585 oscilloscope, DC to 80MHz. With sweep delay. **£275.00.**

TELEEEQUIPMENT D 31 Oscilloscope, dual beam. **£68.00.**

HEATHKIT oscilloscope. **£42.00.**

SEFRAM Model RPS 5-channel variable speed chart recorder, DC to 300Hz. **£85.00.**

NATIONAL CCTV System comprising monitor and camera w lens. **£98.50.**

FERRANTI Gas LASER (probably Helium-Neon). **p.o.a.**

ELECTRONIC ASSOCIATES Gamma spectrometer with NaI probe and recorder. **£120.00.**

EMI 'EBITRON' Image Intensifier vidicon. **p.o.a.**

A SPECIAL FREE OFFER FROM DORAM



Buy either of these superb-value new Doram units, either ready-built or in kit form, and we'll enclose this free digital desk thermometer complete with perpetual calendar and pencil holder, beautifully finished in anodised aluminium.

But hurry! Offer closes March 10th 1978

LOW DISTORTION AUDIO OSCILLATOR

Attractive styling in satin finish avocado and black. Ready built and tested, only £99.95 plus 8% VAT



KEY DATA

Range 10Hz-100kHz in 4 decades
Sinewave distortion < 0.005% at 1 kHz
Output 1 mV-3V pp plus 0-10V square wave
Supply Mains 115/240v 50/60Hz

Save £20! Buy in kit form - £79.95 plus 8% VAT

HARMONIC DISTORTION METER



A perfect match in top quality and styling for the audio oscillator. Ready built and tested, only £99.95 plus 8% VAT.

KEY DATA

Frequency range Continuously variable 20Hz - 40Hz in 7 steps
Input range 60mV - 65V in 3 ranges
Distortion range 100% - 0.03% FSD reading to 0.003%
High impedance input > 75kΩ
BNC connectors. 500 Hz filter. Residual output provided.

Doram Electronics Limited, PO Box TR8, Leeds, LS12 2UF, West Yorkshire

Please send me the following units. I enclose cheque, PO value £.....

Low distortion audio oscillator Order code
Ready-built: £99.95 + 8% VAT. 74-710-7WF
Kit form: £79.95 + 8% VAT. 60-610-7WF
Harmonic distortion meter
Ready-built: £99.95 + 8% VAT. 74-720-0WF
Kit form: £79.95 + 8% VAT. 60-612-1WF

NAME.....
ADDRESS.....

TOWN.....
COUNTY.....

Offer closes March 10th, 1978

DORAM
Department WHF
PO Box TR8,
Leeds LS12 2UF,
West Yorkshire.



DRAKE

Radio Shack Ltd



DRAKE'S SUPERB TRANSCIVER TR-4CW

S.A.E. for details please.

AS WELL AS DRAKE EQUIPMENT, WE ARE THE DIRECT IMPORTERS OF HAL RTTY AND MICROPROCESSORS, ATLAS, NYE MORSE KEYS, PRESTEL VHF/UHF PROFESSIONAL FIELD STRENGTH METERS, HAM RADIO, CIR ASTRO 200, HY-GAIN CDR ROTORS, HUSTLER, OMEGA-T SYSTEMS, MFJ FILTERS AND SPEECH PROCESSORS, SUPREX. WE ALSO STOCK SHURE MICROPHONES, YAESU, MICROWAVE MODULES, SOLID STATE MODULES, ICOM, COPAL CLOCKS, G-WHIPS, BANTEX, MOSLEY, DAIWA, ASAHI, JAYBEAM, DECCA AND THE USUAL ACCESSORIES - COAX, CONNECTORS, INSULATORS, VALVES, Etc.

SEND FOR A COPY OF OUR PRICE LIST (Stamps please)

We are situated just around the corner from West Hampstead Underground Station (Bakerloo line). A few minutes walk away is West Hampstead Midland Region station and West End Lane on the Broad Street Line. We are on the following Bus Routes 28, 59, 159. Hours of opening are 9-5 Monday to Friday. Closed for Lunch 1-2 Saturday we are open 9-12.30 only. World wide exports.

DRAKE * SALES * SERVICE

RADIO SHACK LTD.

188 BROADHURST GARDENS, LONDON NW6 3AY
Giro Account No. 588 7151. Telephone: 01-624 7174. Cables: Radio Shack,
London, N.W.6. Telex: 23718

WW-038 FOR FURTHER DETAILS

£100 off
this super Hi-Fi system the
MATSI TFS60



from the

Lion House

BUDGET HI-FI DEPARTMENT

You can now purchase this fantastic Hi-Fi system complete for only £152.00 at what must be a fraction of its value today.

System consists of:- the famous MATSI TFS60 Tuner/AMP; a really top quality receiver from one of Japan's leading manufacturers, 15 watts per channel FM/MW/LW, two LH6 speakers fitted with AR units and a Goldring belt-drive turntable with magnetic cartridge complete with an attractive plinth & cover of ultra modern design. Leads, etc. supplied free.

LION PRICE: Complete MATSI System £152.00

or purchased individually:

TF60 Receiver: £69.90. LH6 Twin Speakers £55.

Goldring Turntable (cartridge Plinth & Cover) £29.95

Leading suppliers of TELEVISIONS, RADIOS, TAPE RECORDERS, BUDGET HI-FI, CASSETTE RECORDERS, SPEAKERS, AMPLIFIERS, TUNER/AMPS, VIDEO and MUSIC CENTRES and ACCESSORIES, EXPORT TELEVISIONS and MUSICAL INSTRUMENTS. ALL AT KEEN PRICES.



Lion House

277 TOTTENHAM COURT ROAD, LONDON W1
Tel: 01-252 7383 and 01-637 1510
Telex: 28394 LIONH

Open 9.30-6.00 Mon-Fri 9.30-5.00 Sat 10.00-5.00 Sun



WW-034 FOR FURTHER DETAILS

SEND FOR SINTEL FREE CATALOGUE

SINTEL

FAST SERVICE We guarantee that Telephone Orders for goods in stock, received by 4.15 p.m. (Mon-Fri) will be despatched on the same day by 1st Class Post (some heavy items by parcel post) and bus stocking if good. Private customers should telephone and pay by giving their Access or Barclaycard number, with a minimum order value of £5. Official orders, no minimum.

RESEARCH MACHINES 380Z COMPUTER SYSTEM
AVAILABLE THROUGH SINTEL

RESEARCH MACHINES 380Z SYSTEM 16+K
Ready built with 16K RAM, 2K ROM Monitor with Keyboard
As above but with 32K RAM **£1448** With 48K Ram **£1895.00**

RESEARCH MACHINES 380Z SYSTEM 4/KIT
Part assembled with 4K RAM, 2K ROM Monitor Without Keyboard **£539.00**

RESEARCH MACHINES 280Z
2K ROM Monitor 4K RAM **£398.00**

SOFTWARE: 8K Extended Basic for 380Z
Various combinations of the 380Z are available e.g. 4K/48K RAM, Assembled or Part-Assembled Kit Form, with or without Keyboard. PLEASE CONTACT SINTEL FOR FURTHER INFORMATION AND PRICES.
DELIVERY c. 8 weeks. PRICES: Exclusive of VAT and carriage.

MICROPROCESSORS
A SELF-CONTAINED MICROCOMPUTER KIT: THE MEK6800D2. Keyboard Data Entry, 5 Digit Hex Display, Integral Cassette Interface, 256 Words of RAM, Single 4.5V Power Supply.
Order as MEK6800D2 **£190.00**

MC6800 **£15.97** MC6820 **£8.02**
Z80-CPU (2.5MHz) **£28.44** Z80A-CPU (4MHz) **£36.98**
Z80-CTC **£12.80** Z80-PIO **£12.80**

COMPONENTS

SOLDERCON PINS	CLOCK CHIPS	DISPLAYS	CRYSTALS	MEK6800D2	100.00
100	0.50	3.10	3.50	3.50	15.97
1000	4.00	5.60	5.60	3.60	8.02
2000	10.00	7.95	7.95	3.80	28.44
				3.80	36.98
				4.90	12.80
				2.90	12.80

Free data is available on some of these items. SEND FOR FREE CATALOGUE.

CMOS
Major RCA

CD4001	0.17	CD4002	0.18	CD4003	0.23	CD4004	0.23	CD4005	0.23	CD4006	0.23	CD4007	0.23	CD4008	0.23	CD4009	0.23	CD4010	0.23	CD4011	0.23	CD4012	0.23	CD4013	0.23	CD4014	0.23	CD4015	0.23	CD4016	0.23	CD4017	0.23	CD4018	0.23	CD4019	0.23	CD4020	0.23	CD4021	0.23	CD4022	0.23	CD4023	0.23	CD4024	0.23	CD4025	0.23	CD4026	0.23	CD4027	0.23	CD4028	0.23	CD4029	0.23	CD4030	0.23	CD4031	0.23	CD4032	0.23	CD4033	0.23	CD4034	0.23	CD4035	0.23	CD4036	0.23	CD4037	0.23	CD4038	0.23	CD4039	0.23	CD4040	0.23	CD4041	0.23	CD4042	0.23	CD4043	0.23	CD4044	0.23	CD4045	0.23	CD4046	0.23	CD4047	0.23	CD4048	0.23	CD4049	0.23	CD4050	0.23	CD4051	0.23	CD4052	0.23	CD4053	0.23	CD4054	0.23	CD4055	0.23	CD4056	0.23	CD4057	0.23	CD4058	0.23	CD4059	0.23	CD4060	0.23	CD4061	0.23	CD4062	0.23	CD4063	0.23	CD4064	0.23	CD4065	0.23	CD4066	0.23	CD4067	0.23	CD4068	0.23	CD4069	0.23	CD4070	0.23	CD4071	0.23	CD4072	0.23	CD4073	0.23	CD4074	0.23	CD4075	0.23	CD4076	0.23	CD4077	0.23	CD4078	0.23	CD4079	0.23	CD4080	0.23	CD4081	0.23	CD4082	0.23	CD4083	0.23	CD4084	0.23	CD4085	0.23	CD4086	0.23	CD4087	0.23	CD4088	0.23	CD4089	0.23	CD4090	0.23	CD4091	0.23	CD4092	0.23	CD4093	0.23	CD4094	0.23	CD4095	0.23	CD4096	0.23	CD4097	0.23	CD4098	0.23	CD4099	0.23	CD4100	0.23	CD4101	0.23	CD4102	0.23	CD4103	0.23	CD4104	0.23	CD4105	0.23	CD4106	0.23	CD4107	0.23	CD4108	0.23	CD4109	0.23	CD4110	0.23	CD4111	0.23	CD4112	0.23	CD4113	0.23	CD4114	0.23	CD4115	0.23	CD4116	0.23	CD4117	0.23	CD4118	0.23	CD4119	0.23	CD4120	0.23	CD4121	0.23	CD4122	0.23	CD4123	0.23	CD4124	0.23	CD4125	0.23	CD4126	0.23	CD4127	0.23	CD4128	0.23	CD4129	0.23	CD4130	0.23	CD4131	0.23	CD4132	0.23	CD4133	0.23	CD4134	0.23	CD4135	0.23	CD4136	0.23	CD4137	0.23	CD4138	0.23	CD4139	0.23	CD4140	0.23	CD4141	0.23	CD4142	0.23	CD4143	0.23	CD4144	0.23	CD4145	0.23	CD4146	0.23	CD4147	0.23	CD4148	0.23	CD4149	0.23	CD4150	0.23	CD4151	0.23	CD4152	0.23	CD4153	0.23	CD4154	0.23	CD4155	0.23	CD4156	0.23	CD4157	0.23	CD4158	0.23	CD4159	0.23	CD4160	0.23	CD4161	0.23	CD4162	0.23	CD4163	0.23	CD4164	0.23	CD4165	0.23	CD4166	0.23	CD4167	0.23	CD4168	0.23	CD4169	0.23	CD4170	0.23	CD4171	0.23	CD4172	0.23	CD4173	0.23	CD4174	0.23	CD4175	0.23	CD4176	0.23	CD4177	0.23	CD4178	0.23	CD4179	0.23	CD4180	0.23	CD4181	0.23	CD4182	0.23	CD4183	0.23	CD4184	0.23	CD4185	0.23	CD4186	0.23	CD4187	0.23	CD4188	0.23	CD4189	0.23	CD4190	0.23	CD4191	0.23	CD4192	0.23	CD4193	0.23	CD4194	0.23	CD4195	0.23	CD4196	0.23	CD4197	0.23	CD4198	0.23	CD4199	0.23	CD4200	0.23	CD4201	0.23	CD4202	0.23	CD4203	0.23	CD4204	0.23	CD4205	0.23	CD4206	0.23	CD4207	0.23	CD4208	0.23	CD4209	0.23	CD4210	0.23	CD4211	0.23	CD4212	0.23	CD4213	0.23	CD4214	0.23	CD4215	0.23	CD4216	0.23	CD4217	0.23	CD4218	0.23	CD4219	0.23	CD4220	0.23	CD4221	0.23	CD4222	0.23	CD4223	0.23	CD4224	0.23	CD4225	0.23	CD4226	0.23	CD4227	0.23	CD4228	0.23	CD4229	0.23	CD4230	0.23	CD4231	0.23	CD4232	0.23	CD4233	0.23	CD4234	0.23	CD4235	0.23	CD4236	0.23	CD4237	0.23	CD4238	0.23	CD4239	0.23	CD4240	0.23	CD4241	0.23	CD4242	0.23	CD4243	0.23	CD4244	0.23	CD4245	0.23	CD4246	0.23	CD4247	0.23	CD4248	0.23	CD4249	0.23	CD4250	0.23	CD4251	0.23	CD4252	0.23	CD4253	0.23	CD4254	0.23	CD4255	0.23	CD4256	0.23	CD4257	0.23	CD4258	0.23	CD4259	0.23	CD4260	0.23	CD4261	0.23	CD4262	0.23	CD4263	0.23	CD4264	0.23	CD4265	0.23	CD4266	0.23	CD4267	0.23	CD4268	0.23	CD4269	0.23	CD4270	0.23	CD4271	0.23	CD4272	0.23	CD4273	0.23	CD4274	0.23	CD4275	0.23	CD4276	0.23	CD4277	0.23	CD4278	0.23	CD4279	0.23	CD4280	0.23	CD4281	0.23	CD4282	0.23	CD4283	0.23	CD4284	0.23	CD4285	0.23	CD4286	0.23	CD4287	0.23	CD4288	0.23	CD4289	0.23	CD4290	0.23	CD4291	0.23	CD4292	0.23	CD4293	0.23	CD4294	0.23	CD4295	0.23	CD4296	0.23	CD4297	0.23	CD4298	0.23	CD4299	0.23	CD4300	0.23	CD4301	0.23	CD4302	0.23	CD4303	0.23	CD4304	0.23	CD4305	0.23	CD4306	0.23	CD4307	0.23	CD4308	0.23	CD4309	0.23	CD4310	0.23	CD4311	0.23	CD4312	0.23	CD4313	0.23	CD4314	0.23	CD4315	0.23	CD4316	0.23	CD4317	0.23	CD4318	0.23	CD4319	0.23	CD4320	0.23	CD4321	0.23	CD4322	0.23	CD4323	0.23	CD4324	0.23	CD4325	0.23	CD4326	0.23	CD4327	0.23	CD4328	0.23	CD4329	0.23	CD4330	0.23	CD4331	0.23	CD4332	0.23	CD4333	0.23	CD4334	0.23	CD4335	0.23	CD4336	0.23	CD4337	0.23	CD4338	0.23	CD4339	0.23	CD4340	0.23	CD4341	0.23	CD4342	0.23	CD4343	0.23	CD4344	0.23	CD4345	0.23	CD4346	0.23	CD4347	0.23	CD4348	0.23	CD4349	0.23	CD4350	0.23	CD4351	0.23	CD4352	0.23	CD4353	0.23	CD4354	0.23	CD4355	0.23	CD4356	0.23	CD4357	0.23	CD4358	0.23	CD4359	0.23	CD4360	0.23	CD4361	0.23	CD4362	0.23	CD4363	0.23	CD4364	0.23	CD4365	0.23	CD4366	0.23	CD4367	0.23	CD4368	0.23	CD4369	0.23	CD4370	0.23	CD4371	0.23	CD4372	0.23	CD4373	0.23	CD4374	0.23	CD4375	0.23	CD4376	0.23	CD4377	0.23	CD4378	0.23	CD4379	0.23	CD4380	0.23	CD4381	0.23	CD4382	0.23	CD4383	0.23	CD4384	0.23	CD4385	0.23	CD4386	0.23	CD4387	0.23	CD4388	0.23	CD4389	0.23	CD4390	0.23	CD4391	0.23	CD4392	0.23	CD4393	0.23	CD4394	0.23	CD4395	0.23	CD4396	0.23	CD4397	0.23	CD4398	0.23	CD4399	0.23	CD4400	0.23	CD4401	0.23	CD4402	0.23	CD4403	0.23	CD4404	0.23	CD4405	0.23	CD4406	0.23	CD4407	0.23	CD4408	0.23	CD4409	0.23	CD4410	0.23	CD4411	0.23	CD4412	0.23	CD4413	0.23	CD4414	0.23	CD4415	0.23	CD4416	0.23	CD4417	0.23	CD4418	0.23	CD4419	0.23	CD4420	0.23	CD4421	0.23	CD4422	0.23	CD4423	0.23	CD4424	0.23	CD4425	0.23	CD4426	0.23	CD4427	0.23	CD4428	0.23	CD4429	0.23	CD4430	0.23	CD4431	0.23	CD4432	0.23	CD4433	0.23	CD4434	0.23	CD4435	0.23	CD4436	0.23	CD4437	0.23	CD4438	0.23	CD4439	0.23	CD4440	0.23	CD4441	0.23	CD4442	0.23	CD4443	0.23	CD4444	0.23	CD4445	0.23	CD4446	0.23	CD4447	0.23	CD4448	0.23	CD4449	0.23	CD4450	0.23	CD4451	0.23	CD4452	0.23	CD4453	0.23	CD4454	0.23	CD4455	0.23	CD4456	0.23	CD4457	0.23	CD4458	0.23	CD4459	0.23	CD4460	0.23	CD4461	0.23	CD4462	0.23	CD4463	0.23	CD4464	0.23	CD4465	0.23	CD4466	0.23	CD4467	0.23	CD4468	0.23	CD4469	0.23	CD4470	0.23	CD4471	0.23	CD4472	0.23	CD4473	0.23	CD4474	0.23	CD4475	0.23	CD4476	0.23	CD4477	0.23	CD4478	0.23	CD4479	0.23	CD4480	0.23	CD4481	0.23	CD4482	0.23	CD4483	0.23	CD4484	0.23	CD4485	0.23	CD4486	0.23	CD4487	0.23	CD4488	0.23	CD4489	0.23	CD4490	0.23	CD4491	0.23	CD4492	0.23	CD4493	0.23	CD4494	0.23	CD4495	0.23	CD4496	0.23	CD4497	0.23	CD4498	0.23	CD4499	0.23	CD4500	0.23	CD4501	0.23	CD4502	0.23	CD4503	0.23	CD4504	0.23	CD4505	0.23	CD4506	0.23	CD4507	0.23	CD4508	0.23	CD4509	0.23	CD4510	0.23	CD4511	0.23	CD4512	0.23	CD4513	0.23	CD4514	0.23	CD4515	0.23	CD4516	0.23	CD4517	0.23	CD4518	0.23	CD4519	0.23	CD4520	0.23	CD4521
--------	------	--------	------	--------	------	--------	------	--------	------	--------	------	--------	------	--------	------	--------	------	--------	------	--------	------	--------	------	--------	------	--------	------	--------	------	--------	------	--------	------	--------	------	--------	------	--------	------	--------	------	--------	------	--------	------	--------	------	--------	------	--------	------	--------	------	--------	------	--------	------	--------	------	--------	------	--------	------	--------	------	--------	------	--------	------	--------	------	--------	------	--------	------	--------	------	--------	------	--------	------	--------	------	--------	------	--------	------	--------	------	--------	------	--------	------	--------	------	--------	------	--------	------	--------	------	--------	------	--------	------	--------	------	--------	------	--------	------	--------	------	--------	------	--------	------	--------	------	--------	------	--------	------	--------	------	--------	------	--------	------	--------	------	--------	------	--------	------	--------	------	--------	------	--------	------	--------	------	--------	------	--------	------	--------	------	--------	------	--------	------	--------	------	--------	------	--------	------	--------	------	--------	------	--------	------	--------	------	--------	------	--------	------	--------	------	--------	------	--------	------	--------	------	--------	------	--------	------	--------	------	--------	------	--------	------	--------	------	--------	------	--------	------	--------	------	--------	------	--------	------	--------	------	--------	------	--------	------	--------	------	--------	------	--------	------	--------	------	--------	------	--------	------	--------	------	--------	------	--------	------	--------	------	--------	------	--------	------	--------	------	--------	------	--------	------	--------	------	--------	------	--------	------	--------	------	--------	------	--------	------	--------	------	--------	------	--------	------	--------	------	--------	------	--------	------	--------	------	--------	------	--------	------	--------	------	--------	------	--------	------	--------	------	--------	------	--------	------	--------	------	--------	------	--------	------	--------	------	--------	------	--------	------	--------	------	--------	------	--------	------	--------	------	--------	------	--------	------	--------	------	--------	------	--------	------	--------	------	--------	------	--------	------	--------	------	--------	------	--------	------	--------	------	--------	------	--------	------	--------	------	--------	------	--------	------	--------	------	--------	------	--------	------	--------	------	--------	------	--------	------	--------	------	--------	------	--------	------	--------	------	--------	------	--------	------	--------	------	--------	------	--------	------	--------	------	--------	------	--------	------	--------	------	--------	------	--------	------	--------	------	--------	------	--------	------	--------	------	--------	------	--------	------	--------	------	--------	------	--------	------	--------	------	--------	------	--------	------	--------	------	--------	------	--------	------	--------	------	--------	------	--------	------	--------	------	--------	------	--------	------	--------	------	--------	------	--------	------	--------	------	--------	------	--------	------	--------	------	--------	------	--------	------	--------	------	--------	------	--------	------	--------	------	--------	------	--------	------	--------	------	--------	------	--------	------	--------	------	--------	------	--------	------	--------	------	--------	------	--------	------	--------	------	--------	------	--------	------	--------	------	--------	------	--------	------	--------	------	--------	------	--------	------	--------	------	--------	------	--------	------	--------	------	--------	------	--------	------	--------	------	--------	------	--------	------	--------	------	--------	------	--------	------	--------	------	--------	------	--------	------	--------	------	--------	------	--------	------	--------	------	--------	------	--------	------	--------	------	--------	------	--------	------	--------	------	--------	------	--------	------	--------	------	--------	------	--------	------	--------	------	--------	------	--------	------	--------	------	--------	------	--------	------	--------	------	--------	------	--------	------	--------	------	--------	------	--------	------	--------	------	--------	------	--------	------	--------	------	--------	------	--------	------	--------	------	--------	------	--------	------	--------	------	--------	------	--------	------	--------	------	--------	------	--------	------	--------	------	--------	------	--------	------	--------	------	--------	------	--------	------	--------	------	--------	------	--------	------	--------	------	--------	------	--------	------	--------	------	--------	------	--------	------	--------	------	--------	------	--------	------	--------	------	--------	------	--------	------	--------	------	--------	------	--------	------	--------	------	--------	------	--------	------	--------	------	--------	------	--------	------	--------	------	--------	------	--------	------	--------	------	--------	------	--------	------	--------	------	--------	------	--------	------	--------	------	--------	------	--------	------	--------	------	--------	------	--------	------	--------	------	--------	------	--------	------	--------	------	--------	------	--------	------	--------	------	--------	------	--------	------	--------	------	--------	------	--------	------	--------	------	--------	------	--------	------	--------	------	--------	------	--------	------	--------	------	--------	------	--------	------	--------	------	--------	------	--------	------	--------	------	--------	------	--------	------	--------	------	--------	------	--------	------	--------	------	--------	------	--------	------	--------	------	--------	------	--------	------	--------	------	--------	------	--------	------	--------	------	--------	------	--------	------	--------	------	--------	------	--------	------	--------	------	--------	------	--------	------	--------	------	--------	------	--------	------	--------	------	--------	------	--------	------	--------	------	--------	------	--------	------	--------	------	--------	------	--------	------	--------	------	--------	------	--------	------	--------	------	--------	------	--------	------	--------	------	--------	------	--------	------	--------	------	--------	------	--------	------	--------	------	--------	------	--------	------	--------	------	--------	------	--------	------	--------	------	--------	------	--------	------	--------	------	--------	------	--------	------	--------	------	--------	------	--------	------	--------	------	--------	------	--------	------	--------	------	--------	------	--------	------	--------	------	--------	------	--------	------	--------	------	--------	------	--------	------	--------	------	--------	------	--------	------	--------	------	--------	------	--------	------	--------	------	--------	------	--------	------	--------	------	--------	------	--------	------	--------	------	--------	------	--------	------	--------	------	--------	------	--------	------	--------	------	--------	------	--------	------	--------	------	--------	------	--------	------	--------	------	--------	------	--------	------	--------	------	--------	------	--------	------	--------	------	--------	------	--------	------	--------	------	--------	------	--------	------	--------	------	--------	------	--------	------	--------	------	--------	------	--------	------	--------	------	--------	------	--------	------	--------	------	--------	------	--------	------	--------	------	--------	------	--------	------	--------	------	--------	------	--------	------	--------	------	--------	------	--------	------	--------	------	--------	------	--------	------	--------	------	--------	------	--------	------	--------	------	--------	------	--------	------	--------	------	--------	------	--------	------	--------	------	--------	------	--------	------	--------	------	--------	------	--------	------	--------	------	--------	------	--------

TTLs by TEXAS		C-MOS LICS		OP. AMPS		TRANSISTORS		DIODES	
7400	16p	74107	36p	CD4000AE	20p	1458	Dual Op. Amp. Int. Comp.	AC125	35p
74000	28p	74109	89p	CD4001AE	20p	301A	Ext. Comp.	AC129	25p
74500	83p	74110	85p	CD4002AE	20p	3130	CMOS 2-Input Buffer	AC129	25p
74LS00	30p	74111	90p	CD4003AE	85p	CA3140	BIMOS	AD129	25p
7401	18p	74116	200p	CD4007AE	20p	CA3160	Int. Comp.	AD141	20p
7402	18p	74118	84p	CD4009AE	107p	LM319	High Imped.	AD142	20p
7403	18p	74120	120p	CD4009AE	61p	LM324N	Quad Op. Amp.	AD175	25p
7404	23p	74121	32p	CD4010AE	80p	LM349N	Quad Op. Amp.	AD177	25p
74H04	25p	74122	54p	CD4011AE	80p	NE531V	High Imp. Amp.	AD178	25p
7405	25p	74123	75p	CD4012AE	85p	NE543K	Sense Amp.	AD179	25p
7406	43p	74129	73p	CD4013AE	85p	3000	Quad Op. Amp.	AD184	25p
7407	43p	74128	70p	CD4013AE	85p	709	Ext. Comp.	AD185	25p
7408	43p	74128	75p	CD4018AE	50p	741	Int. Comp.	AD192	40p
7409	27p	74132	50p	CD4017AE	100p	742	Ext. Comp.	AF114	30p
7410	18p	74136	75p	CD4018AE	110p	778	Programmable Op. Amp.	AF116	30p
74H10	28p	74141	75p	CD4018AE	110p			AF117	30p
7411	24p	74142	320p	CD4020AE	120p			AF136	43p
7412	25p	74145	90p	CD4022AE	100p			AF236	48p
7413	25p	74147	190p	CD4023AE	22p			BC107	8p
7414	25p	74148	160p	CD4024AE	80p			BC108	8p
7416	33p	74150	140p	CD4025AE	22p			BC109	10p
7417	36p	74151	72p	CD4026AE	170p			BC109C	12p
7420	18p	74163	85p	CD4027AE	85p			BC117	22p
7421	40p	74164	150p	CD4028AE	88p			BC141	8p
7422	22p	74155	90p	CD4029AE	120p			BC142	8p
7423	22p	74156	90p	CD4030AE	55p			BC143	8p
7425	30p	74157	90p	CD4035AE	131p			BC144	8p
7427	37p	74159	190p	CD4040AE	120p			BC145	8p
7428	36p	74160	120p	CD4042AE	90p			BC177	18p
7430	18p	74161	120p	CD4043AE	100p			BC178	17p
7432	36p	74162	120p	CD4046AE	140p			BC179	18p
7437	36p	74163	120p	CD4047AE	100p			BC182	12p
7438	36p	74164	120p	CD4049AE	63p			BC183	12p
7440	19p	74165	220p	CD4050AE	57p			BC184	13p
7441	75p	74166	180p	CD4054AE	120p			BC187	30p
7442	70p	74167	340p	CD4055AE	140p			BC212	11p
7443	140p	74170	250p	CD4056AE	135p			BC213	10p
7444	140p	74172	720p	CD4059AE	600p			BC214	14p
7445	120p	74173	160p	CD4060AE	130p			BC241	36p
7446	100p	74174	120p	CD4069AE	27p			BC478	18p
7447	85p	74175	85p	CD4071AE	27p			BC479	18p
7448	80p	74176	120p	CD4072AE	27p			BC480	18p
7450	18p	74177	120p	CD4073AE	30p			BC481	18p
7451	20p	74179	160p	CD4081AE	21p			BC482	18p
7453	20p	74180	110p	CD4082AE	27p			BC483	18p
7454	18p	74181	200p	CD4093AE	95p			BC484	18p
7460	18p	74182	82p	CD4502AE	138p			BC485	18p
7461	36p	74184	160p	CD4510AE	130p			BC486	18p
7472	30p	74185	150p	CD4511AE	160p			BC487	18p
7473	34p	74186	920p	CD4518AE	112p			BC488	18p
7474	34p	74189	160p	CD4519AE	130p			BC489	18p
7475	45p	74192	160p	CD4528AE	120p			BC490	18p
7476	36p	74193	160p	CD4560BE	250p			BC491	18p
7480	50p	74194	120p					BC492	18p
7481	95p	74195	95p	1702A	850p			BC493	18p
7482	90p	74196	120p	2102.2	200p			BC494	18p
7483	90p	74197	120p	2107	1000p			BC495	18p
7484	120p	74198	250p	2117.2	300p			BC496	18p
7485	110p	74199	250p	2708	2500p			BC497	18p
7486	34p	74221	160p	5101-1	650p			BC498	18p
7489	320p	74251	140p	8810A	400p			BC499	18p
7490	40p	74265	90p	8080A	1200p			BC500	18p
7491	85p	74278	290p	8212	200p			BC501	18p
7492	55p	74279	140p	8224	400p			BC502	18p
7493	40p	74283	190p	8228	700p			BC503	18p
7494	90p	74290	150p	8245	400p			BC504	18p
7495	70p	74293	180p	8251	800p			BC505	18p
7496	84p	74298	200p	8255	800p			BC506	18p
7497	340p	74385	150p	AY-5-1013	600p			BC507	18p
74100	120p	74388	150p	AY-5-2376	1100p			BC508	18p
74104	65p	74390	200p	RS-3-2513	800p			BC509	18p
74105	65p	74393	225p	RS-3-2517	1360p			BC510	18p

TELERADIO SPECIALISTS IN DESIGNS by John Linsley Hood

Example: 25 to 75 watt, Very Low Distortion HIGH FIDELITY STEREO AMPLIFIER D.C. Coupled T.H.D. hardly measurable. £73 in kit form (+12% VAT)



PP extra £2.50

Supplied as a Kit or parts or in ready assembled module form.

Also available: Phase Locked Loop F.M. Tuner, Millivoltmeter, Audio Signal Generators, I.H. Analyser, F.M. Signal Generator/Wobbulator.

Send SAE for comprehensive illustrated lists and up-to-date prices

TELERADIO ELECTRONICS

325 Fore Street, Edmonton, London N9 0PE

Telephone: 01-807 3719 Closed Thursdays

carbon film RESISTORS

ON BANDOLIERS OR PREFORMED 12.5mm AT NO EXTRA COST

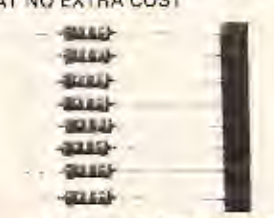

AERO SERVICES LTD.

42-44A.46 Westbourne Grove
London W2 5SF
Tel. 01-727 5841 Telex 261306

PLEASE SEND S.A.E. FOR OUR CATALOGUE

VAT RATES: All items at 8% EXCEPT where marked * which are at 12 1/2%.

TECHNOMATIC LTD.

54 SANDHURST ROAD, LONDON, NW9
Tel: 01-204 4333, Telex 922800

THE DYNAMIC DUO



The C15/15 is a unique Power Amplifier providing Stereo 15 watts per channel or 30 watts Mono and can be used with any car radio / tape unit. It is simply wired in series with the existing speaker leads and in conjunction with our speakers S15 produces a system of incredible performance.

A novel feature is that the amplifier is automatically switched on or off by sensing the power line of the radio / tape unit hence alleviating the need for an on / off switch.

The amplifier is sealed into an integral heatsink and is terminated by screw connectors making installation a very easy process.

The S15 has been specially designed for car use and produces performance equal to domestic speakers yet retaining high power handling and compact size.

C15/15

15 Watts per channel into 4Ω
Distortion 0.2% at 1KHz at 15 watts
Frequency response 50Hz - 30KHz
Input Impedance 8Ω nominal
Input sensitivity 2 volts R.M.S. for 15 watts output
Power line 10 - 18 volts
Open and Short circuit protection
Thermal protection
Size 4 X 4 X 1 inches

C15/15 Price £17.74 + £2.21 VAT P & P free

Data on S15

6" Diameter
5/4" Air Suspension
2" Active Tweeter
20oz Ceramic magnet
15 Watts R.M.S. handling
50 Hz - 15KHz frequency response
4Ω Impedance

S15 Price per pair £17.74 + £2.21 VAT P & P free

TWO YEARS GUARANTEE ON ALL OF OUR PRODUCTS

I.L.P. Electronics Ltd
Crossland House
Nackington, Canterbury
Kent CT4 7AD
Tel (0227) 63218

Please Supply _____
Total Purchase Price _____
I Enclose Cheque Postal Orders Money Order
Please debit my Access account Barclaycard account
Account number _____
Name & Address _____
Signature _____

WEST HYDE

Instrument cases



MOD 3

Other instrument manufacturers' low cost strength and rigidity PVC cases front and rear panels are removable PCB and PSU fits. Also available in black.

WE HAVE MOVED

Our stock of PVC coated cases front and rear panels are removable PCB and PSU fits. Also available in black.

CONTIL

A range of 12 cases, each in stock, featuring: Front panels removable with a price of PVC/Aluminium, also available unpainted up to 1277 (size Aluminium panels extra.

All dimensions are W x H x D (mm) unless stated otherwise. P & P not included.

MOD 3 - 12 cases	
504	7.19
507	7.39
508	8.59
514	7.85
505	9.19
506	10.99

CONTIL TEXTURED	
567	8.58
568	10.30
569	10.30
1277	11.88
1277	11.88
1612	16.38
1910	22.53

ELF CASES (12 cases)	
511	3.20
512	2.15
513	4.30
514	3.80
515	5.40

MOD 2 CASES	
516	8.05
517	9.70

WEST HYDE

MOD 2



Mod 2 cases are 24 sizes. Front and back panels are PVC. Aluminium cases included. Picked for their making blue PVC steel or up to size L also available in wood grain and black.

516	11.34
517	9.72
518	10.80
519	12.30
520	10.76
521	12.36
522	14.51
523	13.82
524	16.17
525	20.00
526	11.66
527	10.67
528	13.53
529	11.38
530	12.98
531	15.25
532	13.28
533	16.27
534	17.92
535	18.77
536	19.64
537	24.10

Three tough 1277 cases add very little to the cost of a job. Front panel aluminium with protective coat. Elf cases are available in 4 sizes, all made available in grey glass polyester, or panels, feet and chassis included.

All West Hyde cases are available with substantial discounts for quantities. Most cases priced in increments of 25 up to 100 off. Prices include P & P and are less 10% if collected, on first two price breaks on cases only.

BUY A CASE FROM A SMALL RANGE, YOU GET A CASE-BUY A CASE FROM A BIG RANGE, YOU GET A SOLUTION

MINOS



A plastic standard case, black PVC sheet top and bottom which can be supplied in white or grey color. Free standing in case returning kit, available in rack or half width assembled in special only a crate pack for safe delivery.



Small miniature ARS cases in tough high glass black. Front panels with an aluminium mesh. Built-in slots for PCB cards, divider line. Chassis in PC boards can be supported on P-type from internal pillars.

THE INSTRUMENT

Instrument cases

BRIGHTCASE MARK II	
BC212 10" Full Height	23.01
BC212 12" Full Height	16.83
BC212 15" Full Height	25.24
BC202 20" Full Height	18.61

More designs available.

MINOS	
M2 6x10x10x10mm	.73
M3 10x10x10x10mm	.84
M4 10x10x10mm	.68
M5 10x10x10mm	.58

HEAVY DUTY CASE	
H1 12x10x7"	16.33
H2 12x10x7"	22.95
H3 12x10x7"	25.95

OVER 400 DIFFERENT CASES IN STOCK—SIZE RANGE OVER 5000:1 IN VOLUME. Prices correct Jan. 1, 1978.

Send for catalogue

WEST HYDE DEVELOPMENTS LIMITED

Unit 6, Park Street Ind. Estate, AYLESBURY, Bucks, HP20 1ET
Tel: 0298 20341 Telex: 83570

SAMOS



Miniature instrument cases in blue and white PVC steel. Assembled in blue or white, slip feet, 2 screws allow the cover to hinge off cases, 2 mm to 100, PC feet are available to hold up to 4 PCB boards horizontally in case.

HEAVY DUTY



Available in 2 sizes. Heavily constructed in zinc steel, welded corners with heavy hinges. 2 screw latches and foam lined door. In the top is a panel with a switch and a chassis with screws provided.

CASE SPECIALISTS

WW - 059 FOR FURTHER DETAILS

VALVES

Minimum Order £1.00	PLUMBICON TUBES TYPE XQ. 1020R Mullard - £150 each	25L0GT
A1055 1.25	SAB 0.60	75 1.00
AR8 0.60	SAC1 0.50	76 0.80
AR9 0.60	SAC2 0.50	77 0.75
ATP4 0.50	SAC3 0.75	78 0.85
BAF06 0.50	SAK8 0.40	79 0.85
BT212 12.85	SAL5 0.30	80 0.85
DF86 0.80	SAL6 0.65	81 0.85
DK95 0.80	SAM5 1.50	82 0.85
DL32 0.50	SAM6 0.65	83 0.85
DL95 0.70	SAN5 0.55	84 0.85
DY80 07 0.50	SAN6 0.50	85 0.85
E80C2 0.43	SAS2W 0.85	86 0.85
EMCC/101.30	SAS5 0.80	87 0.85
EY81 0.50	SAT6 0.65	88 0.85
EY80C 1.30	SAT7 0.40	89 0.85
EY82 2.50	SAT8 0.60	90 0.85
EY83 0.50	SAT9 0.40	91 0.85
EY84 0.50	SAT10 0.40	92 0.85
EY85 0.50	SAT11 0.40	93 0.85
EY86 0.50	SAT12 0.40	94 0.85
EY87 0.50	SAT13 0.40	95 0.85
EY88 0.50	SAT14 0.40	96 0.85
EY89 0.50	SAT15 0.40	97 0.85
EY90 0.50	SAT16 0.40	98 0.85
EY91 0.50	SAT17 0.40	99 0.85
EY92 0.50	SAT18 0.40	100 0.85
EY93 0.50	SAT19 0.40	101 0.85
EY94 0.50	SAT20 0.40	102 0.85
EY95 0.50	SAT21 0.40	103 0.85
EY96 0.50	SAT22 0.40	104 0.85
EY97 0.50	SAT23 0.40	105 0.85
EY98 0.50	SAT24 0.40	106 0.85
EY99 0.50	SAT25 0.40	107 0.85
EY100 0.50	SAT26 0.40	108 0.85
EY101 0.50	SAT27 0.40	109 0.85
EY102 0.50	SAT28 0.40	110 0.85
EY103 0.50	SAT29 0.40	111 0.85
EY104 0.50	SAT30 0.40	112 0.85
EY105 0.50	SAT31 0.40	113 0.85
EY106 0.50	SAT32 0.40	114 0.85
EY107 0.50	SAT33 0.40	115 0.85
EY108 0.50	SAT34 0.40	116 0.85
EY109 0.50	SAT35 0.40	117 0.85
EY110 0.50	SAT36 0.40	118 0.85
EY111 0.50	SAT37 0.40	119 0.85
EY112 0.50	SAT38 0.40	120 0.85
EY113 0.50	SAT39 0.40	121 0.85
EY114 0.50	SAT40 0.40	122 0.85
EY115 0.50	SAT41 0.40	123 0.85
EY116 0.50	SAT42 0.40	124 0.85
EY117 0.50	SAT43 0.40	125 0.85
EY118 0.50	SAT44 0.40	126 0.85
EY119 0.50	SAT45 0.40	127 0.85
EY120 0.50	SAT46 0.40	128 0.85
EY121 0.50	SAT47 0.40	129 0.85
EY122 0.50	SAT48 0.40	130 0.85
EY123 0.50	SAT49 0.40	131 0.85
EY124 0.50	SAT50 0.40	132 0.85
EY125 0.50	SAT51 0.40	133 0.85
EY126 0.50	SAT52 0.40	134 0.85
EY127 0.50	SAT53 0.40	135 0.85
EY128 0.50	SAT54 0.40	136 0.85
EY129 0.50	SAT55 0.40	137 0.85
EY130 0.50	SAT56 0.40	138 0.85
EY131 0.50	SAT57 0.40	139 0.85
EY132 0.50	SAT58 0.40	140 0.85
EY133 0.50	SAT59 0.40	141 0.85
EY134 0.50	SAT60 0.40	142 0.85
EY135 0.50	SAT61 0.40	143 0.85
EY136 0.50	SAT62 0.40	144 0.85
EY137 0.50	SAT63 0.40	145 0.85
EY138 0.50	SAT64 0.40	146 0.85
EY139 0.50	SAT65 0.40	147 0.85
EY140 0.50	SAT66 0.40	148 0.85
EY141 0.50	SAT67 0.40	149 0.85
EY142 0.50	SAT68 0.40	150 0.85
EY143 0.50	SAT69 0.40	151 0.85
EY144 0.50	SAT70 0.40	152 0.85
EY145 0.50	SAT71 0.40	153 0.85
EY146 0.50	SAT72 0.40	154 0.85
EY147 0.50	SAT73 0.40	155 0.85
EY148 0.50	SAT74 0.40	156 0.85
EY149 0.50	SAT75 0.40	157 0.85
EY150 0.50	SAT76 0.40	158 0.85
EY151 0.50	SAT77 0.40	159 0.85
EY152 0.50	SAT78 0.40	160 0.85
EY153 0.50	SAT79 0.40	161 0.85
EY154 0.50	SAT80 0.40	162 0.85
EY155 0.50	SAT81 0.40	163 0.85
EY156 0.50	SAT82 0.40	164 0.85
EY157 0.50	SAT83 0.40	165 0.85
EY158 0.50	SAT84 0.40	166 0.85
EY159 0.50	SAT85 0.40	167 0.85
EY160 0.50	SAT86 0.40	168 0.85
EY161 0.50	SAT87 0.40	169 0.85
EY162 0.50	SAT88 0.40	170 0.85
EY163 0.50	SAT89 0.40	171 0.85
EY164 0.50	SAT90 0.40	172 0.85
EY165 0.50	SAT91 0.40	173 0.85
EY166 0.50	SAT92 0.40	174 0.85
EY167 0.50	SAT93 0.40	175 0.85
EY168 0.50	SAT94 0.40	176 0.85
EY169 0.50	SAT95 0.40	177 0.85
EY170 0.50	SAT96 0.40	178 0.85
EY171 0.50	SAT97 0.40	179 0.85
EY172 0.50	SAT98 0.40	180 0.85
EY173 0.50	SAT99 0.40	181 0.85
EY174 0.50	SAT100 0.40	182 0.85
EY175 0.50	SAT101 0.40	183 0.85
EY176 0.50	SAT102 0.40	184 0.85
EY177 0.50	SAT103 0.40	185 0.85
EY178 0.50	SAT104 0.40	186 0.85
EY179 0.50	SAT105 0.40	187 0.85
EY180 0.50	SAT106 0.40	188 0.85
EY181 0.50	SAT107 0.40	189 0.85
EY182 0.50	SAT108 0.40	190 0.85
EY183 0.50	SAT109 0.40	191 0.85
EY184 0.50	SAT110 0.40	192 0.85
EY185 0.50	SAT111 0.40	193 0.85
EY186 0.50	SAT112 0.40	194 0.85
EY187 0.50	SAT113 0.40	195 0.85
EY188 0.50	SAT114 0.40	196 0.85
EY189 0.50	SAT115 0.40	197 0.85
EY190 0.50	SAT116 0.40	198 0.85
EY191 0.50	SAT117 0.40	199 0.85
EY192 0.50	SAT118 0.40	200 0.85
EY193 0.50	SAT119 0.40	201 0.85
EY194 0.50	SAT120 0.40	202 0.85
EY195 0.50	SAT121 0.40	203 0.85
EY196 0.50	SAT122 0.40	204 0.85
EY197 0.50	SAT123 0.40	205 0.85
EY198 0.50	SAT124 0.40	206 0.85
EY199 0.50	SAT125 0.40	207 0.85
EY200 0.50	SAT126 0.40	208 0.85
EY201 0.50	SAT127 0.40	209 0.85
EY202 0.50	SAT128 0.40	210 0.85
EY203 0.50	SAT129 0.40	211 0.85
EY204 0.50	SAT130 0.40	212 0.85
EY205 0.50	SAT131 0.40	213 0.85
EY206 0.50	SAT132 0.40	214 0.85
EY207 0.50	SAT133 0.40	215 0.85
EY208 0.50	SAT134 0.40	216 0.85
EY209 0.50	SAT135 0.40	217 0.85
EY210 0.50	SAT136 0.40	218 0.85
EY211 0.50	SAT137 0.40	219 0.85
EY212 0.50	SAT138 0.40	220 0.85
EY213 0.50	SAT139 0.40	221 0.85
EY214 0.50	SAT140 0.40	222 0.85
EY215 0.50	SAT141 0.40	223 0.85
EY216 0.50	SAT142 0.40	224 0.85
EY217 0.50	SAT143 0.40	225 0.85
EY218 0.50	SAT144 0.40	226 0.85
EY219 0.50	SAT145 0.40	227 0.85
EY220 0.50	SAT146 0.40	228 0.85
EY221 0.50	SAT147 0.40	229 0.85
EY222 0.50	SAT148 0.40	230 0.85
EY223 0.50	SAT149 0.40	231 0.85
EY224 0.50	SAT150 0.40	232 0.85
EY225 0.50	SAT151 0.40	233 0.85
EY226 0.50	SAT152 0.40	234 0.85
EY227 0.50	SAT153 0.40	235 0.85
EY228 0.50	SAT154 0.40	236 0.85
EY229 0.50	SAT155 0.40	237 0.85
EY230 0.50	SAT156 0.40	238 0.85
EY231 0.50	SAT157 0.40	239 0.85
EY232 0.50	SAT158 0.40	240 0.85
EY233 0.50	SAT159 0.40	241 0.85
EY234 0.50	SAT160 0.40	242 0.85
EY235 0.50	SAT161 0.40	243 0.85
EY236 0.50	SAT162 0.40	244 0.85
EY237 0.50	SAT163 0.40	245 0.85
EY238 0.50	SAT164 0.40	246 0.85
EY239 0.50	SAT165 0.40	247 0.85
EY240 0.50	SAT166 0.40	248 0.85
EY241 0.50	SAT167 0.40	249 0.85
EY242 0.50	SAT168 0.40	250 0.85
EY243 0.50	SAT169 0.40	251 0.85
EY244 0.50	SAT170 0.40	252 0.85
EY245 0.50	SAT171 0.40	253 0.85
EY246 0.50	SAT172 0.40	254 0.85
EY247 0.50	SAT173 0.40	255 0.85
EY248 0.50	SAT174 0.40	256 0.85
EY249 0.50	SAT175 0.40	257 0.85
EY250 0.50	SAT176 0.40	258 0.85
EY251 0.50	SAT177 0.40	259 0.85
EY252 0.50	SAT178 0.40	260 0.85
EY253 0.50	SAT179 0.40	261 0.85
EY254 0.50	SAT180 0.40	262 0.85
EY255 0.50	SAT181 0.40	263 0.85
EY256 0.50	SAT182 0.40	264 0.85
EY257 0.50	SAT183 0.40	265 0.85
EY258 0.50	SAT184 0.40	266 0.85
EY259 0.50	SAT185 0.40	267 0.85
EY260 0.50	SAT186 0.40	268 0.85
EY261 0.50	SAT187 0.40	269 0.85
EY262 0.50	SAT188 0.40	270 0.85
EY263 0.50	SAT189 0.40	271 0.85
EY264 0.50	SAT190 0.40	272 0.85
EY265 0.50	SAT191 0.40	273 0.85
EY266 0.50	SAT192 0.40	274 0.85
EY267 0.50	SAT193 0.40	275 0.85
EY268 0.50	SAT194 0.40	276 0.85
EY269 0.50	SAT195 0.40	277 0.85
EY270 0.50	SAT196 0.40	278 0.85
EY271 0.50	SAT197 0.40	279 0.85
EY272 0.50	SAT198 0.40	280 0.85
EY273 0.50	SAT199 0.40	281 0

STOP HUNTING



4S-6

5 MHz Bandwidth,
10mV/cm Sensitivity,
10ns/cm-100ms/cm
Timebase (16 Calib-
rated Ranges)

4S-6LS

(£135) Designed for
LOW SPEED
Measurement &
10ps/cm-1sec/cm
Timebase

SCOPEX® 4S6 keeps running

£110

Scopex Instruments Ltd, Pixmore Industrial Estate, Pixmore Avenue,
Letchworth, Hertfordshire, SG6 1JJ, Letchworth T2771 (STD 046 26)

© Regd Trade Mark

WW-090 FOR FURTHER DETAILS

TEN GOOD REASONS FOR BUYING THE NEW FLUKE 8020A DMM.



ONLY
£99
PLUS VAT

1. 26 ranges of AC/DC volts and amps, ohms and conductance.
2. 0.25% vdc accuracy over 10°C range for 1 year.
3. 'High power' ohms for diode testing.
4. 'Low power' ohms for in-circuit resistance measurement.
5. Conductance ranges allow leakage measurement to 10,000 MΩ.
6. 9v battery gives typically 200 hrs. life.
7. Protected to 250v dc or rms on any range, any function.
8. Protects to 6kv for 10μs on any range, any function.
9. 2 year warranty on parts and labour.
10. Large liquid crystal display.

Harlow(0279)29522

ITT instrument services

Edinburgh Way, Harlow, Essex, CM20 2DF. Telex 81525

The only way to buy.

WW-010 FOR FURTHER DETAILS

Postage will
be paid by
Licensee

To obtain further details of any of
the coded items mentioned in the
Editorial or Advertisement pages
of this issue, please complete one
or more of the attached cards
entering the reference number(s).
Your enquiries will be passed on to
the manufacturers concerned and
you can expect to hear from them
direct in due course. Cards posted
from abroad require a stamp.
These Service Cards are valid for
six months from the date of
publication.

Please Use Capital Letters

If you are way down on the
circulation list, you may not be
getting the information you
require from the journal as
soon as you should. Why not
have your own copy?

To start a one year's subscription
you may apply direct to us by
using the card at the bottom of
this page. You may also apply to
the agent nearest to you, their
address is shown below.

**OVERSEAS SUBSCRIPTION
AGENTS**

Australia: Gordon &
Gotch (Australasia) Ltd,
380 Lonsdale Street,
Melbourne 3000, Victoria

Belgium: Agence et
Messageries de la Presse,
1 Rue de la Petite-ILE
Brussels 7

Canada: Davis Circulation
Agency, 153 St. Clair
Avenue West, Toronto 195,
Ontario

Cyprus: General Press
Agency Ltd, 131 Pro-
dromou Street, P.O. Box
4528, Nicosia

Denmark: Dansk
Bladdistribution,
Hovedvagtsgade 8,
DK-1103 Kobenhavn.

Finland: Rautakite OY,
Koivuvaatankuja 2,
01640 Vantaa 64, Finland.

France: Dawson-France
S.A., B.P. 40, F-91121,
Palaiseau

Germany: W. E. Seabroch
GmbH, 5 Kola 1,
Follerstrasse 2

Greece: Hellenic
Distribution Agency,
P.O. Box 315, 245
Syngrou Avenue,
Nea Smyrni, Greece.

Holland: Van Ditsmar N.V.,
Oostelijke Handelskade 11,
Amsterdam 1004

India: International Book
House, Indian Mercantile
Mansion Ext, Madame
 Cama Road, Bombay 1

Iran: A.D.A., 151 Khleban
Soraya, Tehran

Israel: Stelmartzky's
Agency Ltd, Citrus House,
P.O. Box 628, Tel Aviv

Italy: Intercontinental
s.a.s. Via Veracini 9,
20124 Milano

Japan: Western Publica-
tions Distribution Agency,
170 Nishi-Okubo
4-chome, Shinjuku-Ku,
Tokyo 160

Lebanon: Levant Distri-
butors Co., P.O. Box 1181,
Makdesi Street, Helim
Hanna Bldg, Beirut

Malaysia: Times
Distributors Sdn. Bhd.,
Times House,
380 Kim Seng Road,
Singapore 9, Malaysia.

Malta: W. H. Smith
Continental Ltd,
18a Scots Street, Valletta

New Zealand: Gordon &
Gotch (New Zealand) Ltd,
102 Adelaide Road,
Wellington 2

Nigeria: Daily Times of
Nigeria Ltd, 3 Kakawa
Street, P.O. Box 139,
Lagos

Norway: A/S Narvesens
Kioskopstern, Bertrand
Narvesens vei 2, Oslo 6

Portugal: Livaria
Bertrand s.a. r.l.
Apartado 37, Amadora

South Africa: Central
News Agency Ltd, P.O.
Box 1033, Johannesburg

Spain: Comercial
Athenium s.a. Consejo de
Ciento, 130-138 Barcelona
15

Sweden: Wennegren
Williams A.B. Fack 6-104,
25 Stockholm 30

Switzerland: Naville &
Cie SA, Rue Levisier 5-7,
CH-1211 Geneva 1
Schmidt Agence AG,
Savogelstrasse 34,
4002 Basle

U.S.A.: John Barlos,
IPC Business Press,
205 East 42nd Street,
New York, N.Y. 10017

BUSINESS REPLY SERVICE
Licence No. 12045

**WIRELESS WORLD,
PRODUCT REPLY SERVICE,
429 BRIGHTON ROAD,
SOUTH CROYDON,
SURREY
CR2 9PS**

21

Enquiry Service for Professional
Readers

WIRELESS WORLD Wireless World, February 1978 WW 862

Please arrange for me to receive further details of the products listed,
the appropriate reference numbers of which have been entered in the
space provided.

Name

Name of Company

Address

Telephone Number

PUBLISHERS USE ONLY		A/E		
------------------------	--	-----	--	--

Position in Company

Nature of Company/Business

No. of employees at this establishment

I wish to subscribe to Wireless World

VALID FOR SIX MONTHS ONLY

**Wireless World:
Subscription Order Form**

To become a subscriber to Wireless World
please complete the reverse side of
this form and return it with your
remittance to:

**Subscription Manager,
IPC Business Press,
Oakfield House, Perrymount Road,
Haywards Heath, Sussex RH16 3DH,
England**

'UL6 the best budget loudspeakers I've heard' says Philip Mount

Reproduced from Practical Hi-Fi Sept. '77

is
pro-
and
ncy
mis-
mit-
ned
tical
inal
ays

're-
in
om
d to
nt at
leph
inals
s the

deli-
ctly
pu-
ve
flat'
l-off,
gain
g an
ncy
The
ects
dge
und
es-
ras
ra-

and
dern
other
A401

'Har-
riled,
rays
and-
end.
s over
asises
vn —
quality
-ice,
the
rd is
jud-
ing
was
fian



Celestion's UL6s

Up to this point you could say the products described are competent by present standards, or even very good. Celestion's UL6 loudspeakers hooked up to the end are unequivocally the best budget loudspeakers I have heard, or in some particular respects, the best loudspeakers I have heard without the qualification of price. Around the time of their introduction a small group of audio journalists was asked by an importer of a certain well-known Japanese brand to give opinions on the quality of a loudspeaker they were about to import. For comparison, about eight popular British loudspeakers had been assembled and connected to a comparator. At the end of the session there was one point on which everybody seemed agreed, and that was the fact that Celestion's UL6 appeared to sound significantly smoother and more evenly balanced than any of the other makes. Since the difference appeared so great, even against significantly more expensive models, I at least wondered whether the particular listening conditions had by some quirk favoured the UL6's by an unusually large degree.

Now, about one year later I find that it wasn't providence and that the speaker easily beats most others into second place by uncanny ability. It was suggested to me for instance, and I think this is true, that the UL6 can be recommended irrespective of taste. Because it's so completely natural and free from major imbalances or defects I believe most people would admit to 1 — liking it, and 2 — finding that they could live with the unit no matter what they had been previously used to. According to taste, you may prefer another loudspeaker with its own peculiar sound, but you would have to admit that this sounds 'right'.

It is common when describing the sound of a loudspeaker to split the audio band into bass, midrange and treble regions, then deal with each separately. This is often provoked by the loudspeaker itself, because most do the same thing and don't present a coherent picture but a fractured programme where

bass output might be, say, soft and distant whilst treble is bright and forward.

This split in quality and relative levels is, as usual, fairly well compensated for by the brain after a short learning and adjustment process. Since it is so common the effect is also tolerated and one does expect to adjust to a speaker's own peculiar sound quality. The most immediately striking feature of the UL6 and the one that caused it to sound superior to all others on that group listening test described earlier is the fact that adjustment hardly seems necessary or called for. There aren't splits, suck-outs or imbalances. The treble doesn't leap out or disappear and you don't have to decide whether you like such-and-such an effect or not. At a broad fundamental level the UL6 just sounds unusually 'right'. I cannot say that behind this overall feeling detail criticisms are impossible but the UL6 certainly transcends its price category and cannot be approached, I feel, by most speakers costing around £200 or less.

If you want to hear a speaker with the whole of the audio range present and transmitted as a smooth coherent whole, listen to the UL6. It's as detailed as any of the best speakers but doesn't achieve this by false upper midrange or treble prominence. An ABR (Auxiliary Bass Radiator) is used to augment bass response and for the first time I can recall it doesn't produce soggy, indefinite bass quality. The main weakness I felt was some wooden nasality in vocals, but this was the only form of coloration easily identifiable.

Percussion instruments were astonishingly powerful and realistic for a speaker of the size and perhaps just a small amount of resonant boom contributed to this very large and excellent performance which will, I assure you, make a majority of budget equivalents sound like neutered cats (which they are) in spite of being, by some that real bass can be wrought from a tarted up shoe box).

Extremely good!

It was the loudspeaker around from so content (that's my fa mediocre to a who tems of far greater cartridge and amp sound balance ter and as I said at ings became o price the result extremely good. Therefore the

Now listen to this...

We don't expect you to take everything you see in the hi-fi magazines about speakers as read. Relying on someone else's ears — even when they are as expert and sensitive as Philip Mount's — isn't quite the same as getting the "message" first hand! But we're more than confident that you will find very little to disagree with once you've heard the UL6 demonstrated.

Celestion



Why not take one of your own records or tapes along to a Celestion dealer and listen.

name _____

address _____

Rola Celestion Ltd., Ditton Works,
Foxhall Road, Ipswich, Suffolk IP3 8JP.
Telephone: Ipswich (0473) 73131.
Cables: Voicecoil Ipswich. Telex: 98365.

07.15.02



NOW — FOR THE MICRO-PROCESSOR USER A LINE PRINTER YOU CAN AFFORD THE I.C.L. 667 BARREL PRINTER

150 lpm x 96 characters; 64 ASCII Character repertoire; Format control, TTL input to hammers and TTL outputs from character and index infra red sensors. Standard 240V Single Phase motors. Attractive Fibreglass case. Size only 28 x 29 1/2 x 12 1/2"

GOOD CONDITION — £62.50 each As New £95 each. Less Hammer Driver Electronics (hence size 13 x 29 1/2 x 12 1/2") £45 each. Carriage all units £3.25.

TEKTRONIX OSCILLOSCOPES

541A with G Plug-in £160. 545 with CA Plug-in £200. 547 Main Frame 581A Main Frame. 585 with S2 Plug-in £426. 661 with 4S1 £350.

Stocks of better oscilloscopes always changing. Enquiries please. Plug-in units not sold separately.

SOLARTRON CD1740 DB-3dB 50MHz. Solid State £375 each.

TEKTRONIX 647 3dB 50MHz £450.

R&S Audio Freq. Spectrograph BN48301 £650.

MARCONI Sweeper TF1099 £45 each

R & S POLYSCOPE SW081 £450 ea.

MARCONI OSCILLOSCOPE TF1330 15 MHz £70 each.

EQUIPMENT Oscilloscope D33R 5 MHz £90 each.

H.P. Oscilloscope type 185B £100 each.

ADVANCE MILLIVOLTMETER VM78 £50 each.

TEKTRONIX OSCILLOSCOPE type 502 High gain. Limited bandwidth £185 each.

EX-MINISTRY X BAND SPECTRUM ANALYSER CT152 (Marconi TF1035) 8.5GHz to 9.7GHz. Power input 115/250V 45.650Hz Fan-climatic £85 each.

J.A.C. ELECTRONICS FREQUENCY METER type 331. Hz to 3 GHz In and Out £55 each.

MARCONI SIGNAL GENERATORS. Freq. range 10-470MHz Type TF801D/1/5 £260 each.

MARCONI AM/FM SIGNAL GENERATOR TF2002B £775

FM/AM SIGNAL GENERATOR type AN/USM 16. 10 to 420MHz. Limited quantity £300 each.

HEWLETT PACKARD OSCILLOSCOPE 175A DC-50MHz Double Beam £190 with delay amp £220.

BRUEL & KJØER Automatic Vibration Exciter type T016. Sine Wave sweep from 5Hz to 10KHz £125 each.

AIRMEC WAVE ANALYSER type 24R £40 each.

POLARAD RECEIVER Model FIM-B2. Complete 1-10GHz £325.

MARCONI Wide Range Oscillator TF1370. Freq. range 10Hz to 10MHz. Sine Wave 10Hz to 100KHz. Square Wave. High outputs up to 31.5V. Good value at £90 each.

MARCONI ADAPTOR TM6113 for TF2700, TF1313, TF8668 £20 each.

AIRMEC 4 trace scope. Type 279. Large screen £95.

MARCONI TF142F DISTORTION FACTOR METER giving percentage distortion on a directly calibrated dial and includes any spurious components up to 30KHz £28.50 ea.

MARCONI PORTABLE FREQUENCY METER TF1026/11. 100 to 160MHz. Very fine condition £25. TF1026/4M 2.4GHz £35 ea.

COURTENAY MAJOR Mk. 2. 250 joules. 5 outputs. Can be combined 1250 joules. No heads £30.

RHODE & SCHWARZ Turnable Indicating Amplifier UBM £75.

TEKTRONIX 180A Time Making Generator £55.

RHODE & SCHWARZ POWER METER. BNRD-BN 2412/50 £50.

MARCONI RF POWER METER. TF1020A/1. 75 ohm £65.

RHODE & SCHWARZ Power Signal Generator BN4100/1. 100KHz to 30MHz £325.

JERROLD SWEEP GENERATOR 900A £165.

TELEVIC SWEEPER SM2000 — many plug-ins available — state frequency required between 0 to 1000MHz.

MARCONI CT44 Watt Meter 0-5 watts £30 ea.

MARCONI TF675P Wide Range Pulse Gen. £18 ea.

EDWARDS HIGH VACUUM PUMPS 15C30 £50, ES35 £40.

MARCONI Signal Generator TF801B/3/5 £160 each.

R. & S. FIELD STRENGTH METER BN1500 with Antennas 0.1 to 3 MHz £195.

H.P. UHF GENERATOR Model 612A 450-1230 MHz £350.

H.P. WAVE ANALYSER type 302A £150.

R. & S. SWEEP GENERATOR BN4242 50KHz-12MHz £176 each.

KAY SWEEPER 1.5MHz-220MHz CW or Sweep £120.

FURZEHILL Valve Voltmeter V200A £25 each.

POWER UNIT 3KV Stabilised £25 each.

FENLOW Low Freq. Analyser 0.3Hz to 1KHz £75.

REMSCOPE 501. Basically working — tube good £75.

H.P. FREQ. CONVERTER type 5252B £50.

S.T.C. DISTORTION SET 74252B £65.

WANDEL & GÖLTERMANN and SIEMENS EQUIPMENT.

LEVEL OSCILLATOR 3W518. SWEEP UNIT WZ.1. LEVEL

OSCILLATOR 3D335. RECEIVER LDE-1. SWEEP

OSCILLATOR 3W938b1a. TRANSMITTER LDE-1. LEVEL

TRACER (Display) 3D34851a. CARRIER FREQUENCY

LEVEL METER TFPM.78. LEVEL TRANSMITTER TFP.75.

CRT INDICATOR with Plug-ins SG-1. SWEEP CONVERTOR

WU.1

Other units available. Average price £120 per unit. Reduction for quantity.

FEED BACK LTD. Wave Form Gen. Sin/Trip/Saw/Sa. + DC offset £80.

TEKTRONIX DIGITAL UNIT. Type 230. Superb £100

GENERAL RADIO PULSE SWEEP GEN. Type 1391B £90

GENERAL RADIO, Osc. Unit 1209B. 750-920Megs. £50 each.

AIRMEC AM/FM SIG. GEN. Type 407. 200KHz-80MHz £300.

FLUKE AC-DC VOLTMETER. Model 803B £90 each.

WOODEN C.V. TRANSFORMERS. 230V input. 5.5V 5A output £2 each.

ALCAD CELLS 40APH. Type EP4. Size 4 1/2 x 2 1/2 x 9 1/2" high. Supplied less fluid £6 each. P&P £1.75.

BROOKFIELD VISCOMETER Model RVT complete with 7 spindles & stand. For 230V 50Hz. As new £275.

EX-MINISTRY OSCILLOSCOPE CT436

Double Beam DC-6 MHz £120

MARCONI TF801D/8/S SIGNAL GENERATOR

Very good condition
£425 each

PICK-A-PACK — 50 PENCE A POUND

From our "Pick-A-Pack" area weigh up your own components. No restrictions on what you take.

EX-DYNAMCO Oscilloscopes INVERTERS 30V Input 6KV Output. Size 2" x 4 1/2" x 1 1/2". Complete with circuit £10 each. P&P £1.

MINIATURE — ONLY MATCH PANELS — BRAND NEW ex-DYNAMCO. 10 x 10 complete with pins £8 each. P&P 50p.

TELEPHONES. Post free style 750. 300k or two-tone £5.50 ea. Modern style 708. Black or two-tone grey £4.50 ea. P&P £1 each. Old black style £1.50 each. P&P £1.

HANDSETS only 708 style £1.75 each. Older styles £1. P&P 75p.

TELEPHONE EXCHANGES. 5g. 15-wky automatic repair charge only from £95.

SURPLUS — BRAND NEW — REPLACEMENT TUBES FOR DYNAMCO 7100 SERIES OSCILLOSCOPES TYPE BEMERD D13-5108 Mesh P D A. Transistor Scan. Wave Bandwidth 80MHz. Rectangular 5 x 10cm. 1.4V 5HT x Sensitivity 15v. CM. Y Sensitivity 5V. CM. standard heaters. Length 12 1/2"

THIS IS A MUST AS A SPARE FOR THE DYNAMCO 7100 SCOPE OR IDEAL FOR THE HIGH QUALITY TRANSISTOR SCOPE BUILDER. At £15 each. Carriage £3.00.

To tube purchasers only. Nominal Stock at £2.50.

PAPST Moon 240V available at £7.50 ea. P&P 75p.

PHOTOMULTIPLIER Type D13A £4 ea. P&P 75p. Other types available.

RESERVE TRIMMERS 3. 30p. Brand New. 10 ea. 40p P&P 15p. 100 off £3.50. P&P 75p. 500 off £15. P&P £1.25. 1000 off £25. P&P £5.

LARGE RANGE OF ELECTROSTATIC VOLTMETERS. From 0.30KV/2" £3. to 20KV Max. General purpose 5KV 3" £5. Transistor £1 per KV. P&P 75p.

DON'T FORGET YOUR MANUALS. S.A.E. with request.

E.H.T. TRANSFORMERS 20KV 2KV £70 ea. 25KV SINGLE PHASE 20KV 50mA 2 x 2KV £85. 25KV SINGLE PHASE 1KV Output 10KV 25MA £175. Manufacturer's EHT Transformers and EHT Capacitors available.

* SEMICONDUCTOR PACK

Guaranteed full spec. devices make up this pack (No large quantities warrant individual advertising).

50 devices for £1 P&P 40p
Highly Recommended

* I.C. BOARD PACK

50 I.C.s and other useful components for £1 P&P 75p.

MULLARD & BRIMAR OSCILLOSCOPE TUBES

BRAND NEW BOXED — ALL RECTANGULAR

014-121. Green 50MHz Y 4.2V/CV £45 ea. As above but P7 Phosphor £35 ea. D13-46GM P7 £35 ea. D10-210GH/32 £40 ea. Carriage all tubes £1.75 ea.

COSSOR OSCILLOSCOPE CAMERAS

Brand New Boxed with 4 film packs & Manual £12 each. Carriage £2.75.

SOLID STATE TIMEBASES

By LARGE BRITISH MANUFACTURERS

These are a Plug-in Modular Timebase covering 0.2 microsec per cm to 5 sec per cm in 23 steps. Tunnel Diode triggering. 8 Front Panel Controls. 37 Transistors/FETs — all plug-in. Silver anodised front panel. Size 4 x 5 1/2 x 10 1/2" deep. Guaranteed absolutely brand new in original manufacturer's packaging. Complete with extremely comprehensive copy of manual. £17.50 ea. P&P £2.

FURZEHILL EX-MINISTRY AUDIO GENERATOR 0-20KHZ

Sinewave output. Metered. 600 Ohms. Size 16 x 10 x 9" deep. Standard mains now at £15 ea.

TRIPODS
P&T HEAD
£22.50 each

MARCONI VALVE
VOLTMETER
TF428B £15 ea.

DEC. MODULES

M8357 M7264 M7847BJ
M8655 M7228 MMV11

Prices and other Modules available on application

* TRANSISTORS/DIODES/ RECTIFIERS, ETC.

Guaranteed all full spec. devices. Manufacturers' Markings.

At 6p each
BC147, 2N3767, 2N4403, BC172B, BC261, BC251B, BC348B, BC171A/B, BC413, D10, BC182, BC212, BAX13, 1N937, BA102BE, 6X83, 2N4047, T1S61, 2N5040.

At 10p each
BFX85, 1N4733A, 5N7451N, BYX10 1.5KV, 0.36A, BYZ10 15p ea. TIP30 20p ea. TIP34A — 50p ea. BD538 — 40p ea. Heavy Duty Bridge Rectifier — 20p ea. 1BA810S — 75p ea. CA3123E — £1 ea. BDY55 — £1 ea. BU104 — £1 ea. 2N3055 — 40p ea.

1BA580CD £2 ea. 1M4435T — T03 Flat mount 10A 200piv £1 ea. 2N5879 with 2N5881 Motorola 150W Comp pair £2 pr. BD535/BD538 Comp. pair — 75p pr.

Linear Amp 709 — 25p ea.
High Speed Voltage Comparator 710 — 15p ea.
P&P Extra on all items.

FINNED HEAT SINK — single 103 — Size 4 1/2" x 3" x 1 1/4" 50p ea. P&P 75p.

DESKS with Punch Reader, Printer and Keyboard. Some ASCII. Various models from £200.

1/2" MAG TAPE

Approx. 2,000 ft. NOW 25p each. P&P £1. Or 5 for £1 ea. £2.75p.

FOR THE VDU BUILDER size type CME T22D 24 x 15cm at £9 ea. Base connections supplied.

Heads for PERDEC 6000/7000 — enquiries.

VDU BOARD ASSEMBLY

Single board approx. 12" x 8" — can be supplied cut into 4 Eurocard boards. 40 characters x 24 lines; 64 ASCII characters, flashing cursor, 32 control functions, adjustable baud rate; keyboard input; serial input/output; requires +5V and -12V and any modified television or video monitor. Guaranteed to provide a rock steady picture. Supplied in kit form (all components supplied) £95. Assembled and tested £147.50. P&P £1.75.

TELETYPE ASR 33 from £450

TELETYPE KSR33 £325

NON-STANDARD KSR33 eg basic ASCII + 20MA loop — but small print 0 to 9 above standard 0 to 9. some of the symbols having been relocated. £250.

TELETYPE 35R0 — no cases. £120 each.

TELETYPE 35R0 cased. £180 each.

TELETYPE 35R0 cased — with remote electronic keyboard £370 each.

VITRON PROCESSOR consisting of VDU, twin cassette information. £325. One only.

MELCOM 83 System with information. £425.

LITTON SYSTEM — Must go — £375 or offer.

BACK IN STOCK —

CREED 7B TELEPRINTERS

THE CHEAPEST WAY OF GETTING A FULL ALPHA/NUMERIC PRINTOUT FROM YOUR MICRO

Large Ministry purchase enables us to offer these at

£25 each

In good working condition. Requires 110 volts DC. Requires ASCII/BAUDOT converter for coupling to your micro-processor.

These units are Processor tested before dispatch. Cables included. Absolutely packed to guarantee safe arrival for £3.25.

A LARGE QUANTITY OF MISCELLANEOUS TEST GEAR — CHASSIS UNITS, ETC., on view at LOW COST

Minimum Mail Order £2. Excess postage refunded. Unless stated — please add £2.75 carriage to all units. VALUE ADDED TAX not included in prices — Goods marked with * 12 1/2% VAT, otherwise 8%.

Official Orders Welcomed. Gov./Educational Epts., Authorities, etc., otherwise Cash with Order.

Open 9 a.m. to 5.30 p.m. Mon. to Sat.



CHILTHEAD LTD



7/9 ARTHUR ROAD, READING, BERKS (near Tech. College, King's Road). Tel. Reading 582605

Electronic Brokers Ltd

The Test Equipment People

EXTRA SPECIAL OFFERS

MARCONI INSTRUMENTS TF2333 M.F. TRANSMISSION MEASURING SET



Freq. range 30Hz-550 KHz (5 ranges)
Attenuator Range
70dB in 10 dB and 1 dB steps
Level Measurement +25 to -70 dBm
Measures response of active and passive transmission networks

**REFURBISHED AND
RECALIBRATED TO SPEC.
£600.00**

LIST PRICE £900 +

MARCONI INSTRUMENTS TF893A A.F. POWER METER

FREQ. RANGE: 20Hz to 35KHz
5 power ranges 1mW to 10W.
Impedance 2.5 ohms to 20Kohms.
in 48 steps. Balanced or unbalanced.
inputs. Direct calibration in watts and dBm.

**REFURBISHED AND
RECALIBRATED TO SPEC.
NEW LIST PRICE £260.00 £155.00**

WIDE RANGE MULTIMETER UM11 BRAND NEW



**SPECIAL LOW PRICE FOR
LIMITED PERIOD ONLY:**
38 ranges. High input impedance
* DC Volts. 150mV to 1500V f.s.d. @
100K Ohms/V.
* AC Volts. 1.5 to 1500V f.s.d. @
31.8K Ohms/V.
* DC Current 10µA to 15A f.s.d.
* AC Current 15A.
* Mirror scale, rugged taut-band sus-
pension, dB scale, diode and fuse
protection.
* Supplied complete with test leads
and leather carrying case
* 3 months' warranty

**NORMAL PRICE £39.50
£29.50**

BRAND NEW FUNCTION GENERATORS



**Special Low Prices
for Limited Period
while Stocks last**

G.430
(illustrated)
* Frequency: 1 Hz to 1
MHz * Output: Sine
wave, 0-10V r.m.s.
from 600 Square-
wave 0-20V p.p. from
600. * 0-60 dB step
attenuator

**NORMAL PRICE
£95.00**

G.432
* Frequency 1 Hz to 1 MHz. * Sine, square
and triangle. * 5V from 0.60 dB 50 attenuator
dependent 600 outputs. * D.C. offset.

**NORMAL PRICE
£115.00**

£79.50 6 MONTH WARRANTY

DYNAMCO MODEL 7100 PORTABLE DUAL CHANNEL OSCILLOSCOPE

Supplied with plug in units
1X2 and 1Y2.
New condition.
DC to 30MHz
Rise Time: 12ns
10mV/div. also X10 gain
provides 1mV/div. (10Hz-
5MHz)
Comprehensive sweep de-
lay timebase.
Full spec. on request



**TODAY'S VALUE
£500 PLUS
UNUSED
£350.00**

HEWLETT PACKARD 332A DISTORTION ANALYSER

Fundamental Frequency Range 5Hz-600 KHz
Distortion levels of 0.1%-100% are measured full scale in 7 ranges
A.M. Detector facility

**REFURBISHED AND
RECALIBRATED TO SPEC.
OUR PRICE £495.00**

RACAL RA117 H.F. COMMUNICATIONS RECEIVER

FREQ.: 1-30MHz
TUNING: Effective scale length of 145 feet i.e. 6" corresponding to 100KHz
CALIBRATION: 100KHz signal derived from 1MHz Xtal oscillator accuracy 5
parts in 10⁶ provides check points at 100KHz intervals.
SENSITIVITY: A1 reception b/w 3KHz; 1µV for 18dB signal to noise ratio.
A2 reception, 30% mod. b/w 3KHz; 3µV for 18dB signal to noise ratio.
Intermodulation > 100dB down. Selectivity 5 J.I. bandwidths are obtained by
means of a selector switch. Full Spec. on request. Completely refurbished and
localised.

TODAY'S VALUE AT LEAST £600.00

SUPERB CONDITION £350.00

FLUKE MULTIFUNCTION COUNTER 1900A



FREQ: 5Hz - 80MHz
TOTALIZE: 1 to 999999
SENSITIVITY: 25mV, typically 15mV-5Hz to 80MHz
Autorangeing, 6 digit LED display, 10:1 attenuator

**LIST
PRICE
£199.00**

**BRAND NEW
£175.00**

BULK PURCHASE

ELECTRONIC BROKERS LIMITED
49-53 Pancras Road, London NW1 2QB
Tel. 01-837 7781. Telex: 298694

Hours of Business: 9 a.m.-5 p.m.
Mon.-Fri.: closed lunch 1-2 p.m.

Carriage and Packing charge extra on all
items unless otherwise stated.

WW-077 FOR FURTHER DETAILS

**ADD 8%
VAT
TO ALL
PRICES**

Electronic

The Test Equipment People

SIGNAL SOURCES

ADVANCE
V.H.F. Square wave Generator SG21. 10 KHz-100MHz Max. o/p 2V **£50.00**
H.F. Audio Signal Generator. Sine & Square Wave 15Hz-50KHz. 200V to 20V (Sine). Distortion 1% 1.4mV to 140V (Square) Brand new condition **£75.00**



Type PG59 Pulse Generator 2 Channel double pulse. Functions: Frequency, Width, Rise & Fall Time, Amplitude, Offset, Delay, Prepulse & Gate. Repetition Freq. 1Hz to 10MHz (20 MHz in double pulse mode). Delay & Width 25 nsecs/1sec. Full specification on request. **£595.00**

Type SG67A Wide Range Oscillator. Freq. Range 1Hz-1MHz. Sine or Square. Output Amplitude up to 2.5V. Battery operated. **£95.00**

R.F. Signal Generator B4B7 30KHz-30MHz. Output Z = 75. Int. Mod. 400Hz. 0-80%. Provision for Ext. Mod. Audio o/p 0.1-10V at 400 Hz into 600Ω. **£165**

SG68A Low Distortion Oscillator. 1.5Hz-150KHz c/w BE2 battery pack. New condition **£200.00**

HEWLETT PACKARD
10515A Frequency Doubler **£75.00**
F.M./A.M. Signal Generator 202H. F.M. A.M. C.W. & pulse coverage 54 to 216MHz R.F. o/p 0.1µV-0.2V 50ohms Impedance **£495.00**
B12A-L.H.F. Signal Generator 450-1230MHz. 0.1µV-0.5V (50ohms) A.M. Internal & external Pulse mod. facilities. SUPERB CONDITION **£1250.00**
E08A A.M. Signal Generator 50KHz-65MHz **£550.00**

MARCONI INSTRUMENTS
TF1050 U.H.F. Signal Generator 450-1250MHz. Sine wave and pulse a.m. **£400.00**
Signal Generator TF867. 15KHz-30MHz a/p 0.4µV-4V Int. & Ext. mod. Supplied with Terminating unit **£185.00**
Solid State Generator 8058B. Freq. range 3-12.5GHz. Int. & Ext. mod. freq. Stab. 0.003%. 50Ω impedance **£530.00**
A.M. Signal Generator TF801D/15 Military version 10-485MHz **£450.00-£800.00**

R.C. Oscillator TF1370A. 10Hz-10MHz Square Wave up to 100KHz High Outputs up to 31.6V **£225.00**
Phase/A.M. Signal Generator TF 2003 0.4-12MHz **£150.00**
A.M. Signal Generator TF801D/1. Freq. range 10-470MHz R.F. output 0.1µV-1V. Piston attenuator. 50ohms impedance. Signal Generator TF144H/4. Later models in super condition **£500.00 to £850.00**

TF2002 A.M. Signal Generator 10KHz-72 MHz. 100% A.M. depth. Int. a.m. variable 20Hz-20KHz. R.F. o/p 0.1µV-2V. Solid State **£675.00**
TF995B/5 F.M./A.M. Signal Generator 200KHz-220MHz **£675.00**
TF1101 R.C. Oscillator 20Hz-200KHz. 600ohm impedance. Output variable 1mV-20V **£105.00**
TF2000 A.F. Signal Source 20Hz-20KHz. 111dB Attenuator in 0.1 dB steps. Low distortion **£325.00**
TF2005R Two Tone Signal Source. 2 identical oscillators. 20Hz-20KHz. <0.1% distortion for intermodulation measurements on high quality A.F. equipment **£415.00**



PHILIPS
50MHz Pulse Generator PM5712 **£495.00**
Pulse Generator PM5775 **£800.00**
Pulse Generator PM5776 **£900.00**
L.F. Generator PM5105. 10Hz-100KHz. Sine & Square Wave 2VR (M.S.) Stabilised o/p. Low Distortion <0.8% (10Hz-100KHz) **£156.00**

RADIOMETER
SMC1C Stereo Signal Generator **£350.00**

DIGITAL VOLTMETERS AND MULTIMETERS

AVO
Test leads **£4.00**
Multimeter Mk 4 c/w carrying case and leads **£14.00**
Model 7x **£40.00**
Heavy Duty Mk 5 (with case) **£40.00**
AVO Model 8X **£53.00**
AVO Model 9 or Test Set No. 1 **£55.00**

DYNAMCO
Digital Voltmeter DM 2023 c/w DC ranging unit C1 Scale 99999 0.001% F.S.D. DC Accuracy 10µV-1Kv DC **£450.00**

FLUKE
DC Digital Voltmeter 8200A 4 1/2 digit. 80% overranging. autoranging, push button range and function selection, full guarding and a selectable input filter. Many options can be obtained for expanding the 8200A capabilities **£595.00**

HEWLETT PACKARD
DVM type 3430A 3 digit 5 ranges 100mV to 100V. FS input resistances 10Mohms. Overload protection **£145.00**
Digital multimeter 3470 2A with Display 34740A. 4 digit display. 4 ranges both AC & DC plus 8 ranges of ohms. AC function covers 45Hz to 100KHz. Ohms ranges are 100ohms to 10Mohms FS LED display. New condition. **£400.00**

PHILIPS
Electronic Analogue Multimeter PM2503 DC & AC Volts, 100mV-1KV f.s.d. Resistance 100 ohms-10M Ohms. DC & AC Current 1mA-1A f.s.d. **£90.00**

SIGN/ROGERS
A.F. Voltmeter AM324 **£50.00**

SOLARTRON
A.C. Converter LM1219. 30mV-300V mean reading. Freq. range 10Hz-10KHz. **P.O.A.**

D.C. Digital Voltmeter LM1420 2 2 1/2µV-1Kv in 5 ranges -0.05% DC accuracy **£235.00**

D.V.M. Type LM1420 28A. DC, true R.M.S. and mean A.C. sensing. Accurate measurement irrespective of harmonic distortion accuracy ±0.25%. Freq. 20Hz-20KHz **£350.00**

DVM Type LM 1440. 2 10µV-2Kv DC. 5 ranges. Oven controlled zener diode. Accuracy ±0.033% FSD ±0.005% reading **P.O.A.**

D.V.M. LM1480.3 Autoranging version of LM 1440.3. Max. reading 39999 5µV-2Kv DC. Full spec. on request. **P.O.A.**

D.M.M. 7050 (Autoranging) **£245.00**

SCOPE TEST EQUIPMENT

TEKTRONIX
Time Mark Generator 184 **£275.00**



5nscc Pulse Generator Model 2101 c/w leads and connectors **£575.00**
Time Mark Generator 2901 **£450.00**
Pulse Generator Model 110 **£95.00**

OSCILLOSCOPES

COSSOR
Dual Trace Scope 4000 50MHz 7nscc Rise Time 5mV/cm sensitivity. Calibrated sweep delay. Gated trigger. XY display 8 x 10cm display **£496.00**



DYNAMCO
Portable Scope 7200. Plug Ins 7201 & 7212. Solid State. Capable of being powered from AC or DC. DC 15MHz at 10mV/div. Dual Channel X10 Gain. Calibrated sweep delay **£315.00**
Precision TV Waveform Monitor 7060 Plug Ins 7174 & 7178. Full spec. on request **£850.00**

HEWLETT PACKARD
Portable Oscilloscope 1707A DC-75MHz. Dual channel 6 x 10cm display. Sensitivity -10mV/Div. Sweep delayed time base. **£825.00**

PHILIPS
PM6507 Transistor Curve Tracer. Solid State CRT - 10 x 12cm. Full spec. on request **£475.00**

PROBES
X1 Part No. 90 **£7.00**
X10 Part No. 91 **£9.00**
X1 & X10 (switchable) Part No. 95 **£11.00**

SOLARTRON
CT436 Dual Beam DC-6MHz. 100mV/cm AC x 10 giving 10mV/min sensitivity **£105.00**
CD1400 DC-15MHz. c/w Plug Ins 2 x CX1441 & 1 x CX1444 Calibrated sweep delay. 5" diam CRT **£190.00**

TEKTRONIX
DC30MHz Oscilloscope 545A c/w CA & 1 Plug-ins **£445.00**



Type 485 350MHz Portable. Dual Trace 5mV/div. 1nscc/div sweep rate. Delayed sweep. Auto focus, variable trigger hold off 50 ohms internal input protection **£3,280.00**

Type 551 DC-27MHz. Main frame and power supply. Various plug-in units available **£450.00**

Type 564B (Mainframe) Storage Oscilloscope. Various plug-in units available **£750.00**

847A (CT536A) Ruggedised DC-100MHz Dual Trace. Including Plug Ins 10A2A & 11B2A **£1,200.00**
849B DC-33MHz c/w 1A1 Plug In **£450.00**

533A DC-13MHz c/w CA Plug In **£225.00**

545B DC-33MHz c/w 1A1 Plug In **£600.00**

561A Sampling scope c/w 3576 & 3177 **£650.00**

555 (Including P/Supply) c/w 2 x 1A1 Plug Ins **£895.00**

587A DC-60MHz c/w Dual Trace Type 87 **£600.00**

585A DC-80MHz c/w Dual Trace Type B2 **£775.00**

TYPE M Plug In. 4 Trace **£250.00**

TYPE W Plug In. Differential **£325.00**



49-53 Pancras Road
London NW1 2QB

ADD 8% VAT
TO ALL PRICES

Tel: 01-837 7781. Telex: 298694

Brokers Ltd

49-53 Pancras Road,
London NW1 2QB
Tel: 01-837 7781

New Catalogue just
out. Send for your
copy now - POST
FREE



TYPE 132 Plug In Unit Power Supply £120.00
TYPE 151 Plug In Unit (without accessories) £200.00

TELEQUIPMENT



Rack Mounting Scope S54AR Fitted with P7 long persistence CRT. Single trace. DC-10MHz. 10mV/cm. Unused condition £205.00

TRANSMISSION TEST EQUIPMENT

AIRMEC/RACAL
Wave Analyser 248A. 5-300MHz £250.00-£300.00
Wave Analyser 248. Freq. range 5MHz-300MHz £145.00
Modulation Meter 409 £295.00
Type 210A Modulation Meter. 2.5-300MHz. AM Range 0-100%. FM Range 0 to 100KHz in 4 ranges. £185.00-£245.00

GENERAL RADIO
Type 1800A Wave Analyser c/w Graphic Level Recorder 1521B
Spec. 1800A, 20Hz-50KHz. 3 bandwidths 3, 10 and 50Hz Tracking averages 30mV-300V r.m.s. Input impedance 1M ohm 3 meter speeds
Spec. 1521B 4.5Hz-200KHz 1 mV sensitivity. Linear dB plot of r.m.s. ac-voltage level 20, 40 or 80 dB range £2,000.00

HEWLETT PACKARD
Sweeping Local Oscillator 3595A Plug-in for use with 3590A Wave Analyser Freq. range 20Hz to 620KHz £650.00

MARCONI INSTRUMENTS
Distortion Factor Meter TF142F Fundamental Freq. Range 100Hz-8KHz. Dist. measuring ranges 0.5% - 0.50%. Measures all spurious components up to 30KHz £60.00-£80.00

BRIDGES

WAYNE KERR
COMPONENT BRIDGE B521 (CT375). Resistance 10 ranges from 1M ohm to 1000M ohm. Capacitance 10 ranges from 50nF to 500pF. Inductance 10 ranges from 1uF to 500 KH. Capable of measuring components in situ. £105.00
Universal Bridge B221A (CT530). 0.1% Accuracy. Measures R, C & L. Mains operated £275.00
Low Impedance Adaptor Q221A for use with above £75.00

FREQUENCY COUNTERS

ADVANCE
Counter TC15 5Hz-80MHz. 5 digit £110.00
Timer Counter TC14 9 digit. Display storage. DC - 250MHz. Time limits selectable 0.1µs-100s. Multiple period average 10:10. Sensitivity 10mV, 100mV, 500mV. Overload protected £475.00
Timer Counter TC15 9 digit with storage, and plug-in capability. DC - 250MHz. Spec. similar to TC14 £585.00
Plug-In Unit TC15 P1 1MHz-500MHz. 10mV-1V. Full 500MHz display with 1Hz resolution in only 2 secs. £200.00
Timer Counter TC17A 6 digit, DC to 80MHz. Gate times 10µs to 10s in decade steps. Sensitivity 25mV (r.m.s.) sine wave. Overload protected £290.00
Timer Counter TC22. Measures - Frequency DC - 100MHz. 6 digit. Time, period, period average, count, totales, pulse width, ratio. £300.00
Type TC18 Time Counter Freq. measurement 10Hz-512MHz. 6 digit LED display UNUSED CONDITION £275.00

FLUKE
Industrial Counter Totaliser 1941A. 5Hz-40MHz. 40mV sensitivity R.P.M. measurement £150.00
Communications Counter 1920A 5Hz-520MHz. 15mV sensitivity 9 digit LED Display £400.00
RACAL
Frequency Period Meter 5Hz-10MHz 9520. Period Average measurements £110.00
Universal Counter Timer 9838. Measuring functions - Frequency Single and multi period. Ratio and Multiple ratio. Time interval - single line and double line totalising. 10 Hz to 100 MHz Frequency 10 Hz to 5 MHz Period. 1µs to 10⁵ sec. Time change £285.00

VOLTMETERS

BOONTON
R.F. Voltmeter BT C. Measurement range 1mV to 3V. Frequency range 20 KHz to 1200 MHz (with 'T' Adaptor supplied). Supplies also with R.F. probe and tip and 50Ω termination. Weight 12 lbs. £455.00

BRUEL & KJOER
Electronic Voltmeter 2409. True R.M.S. Average and Peak. 2Hz to 200KHz. Sensitivity 10mV - 1kV £250.00

FLUKE
DC Differential Voltmeter 891A. Input ranges, 1, 10, 100, 1000V. DC with 10% averaging. Infinite input resistance 0-1100V. Absolute accuracy ± 0.01% of input. 1 mV full scale Null Sensitivity. Resolution 1 ppm of range £395.00

GENERAL RADIO
Electronic Voltmeter 1806A AC DC 9 Resistance = 2% accuracy. Wide frequency range - up to 1500MHz £175.00

HEWLETT PACKARD
R.F. Voltmeter 3406A 20µV sensitivity - average response. 1mV sensitivity. 1mV - 3V.F.S. 9 ranges. 10KHz - 1.2GHz £485.00

RHODE & SCHWARZ
Selective Microvoltmeter USVH BN 1521 10KHz - 30MHz. 0.2V - 1V. F.s.d. of lowest range 1V £675.00

MARCONI INSTRUMENTS
TF2600 Sensitive Valve Voltmeter 1mV-300V (12 ranges) 1% Accuracy up to 500KHz £175.00
TF2604 R.F. Electronic Voltmeter 300mV-300V (7 ranges) 20Hz-1.5GHz 300mV-1kV DC 500ohms-500Mohms £225.00

MISCELLANEOUS

ADVANCE
Digital Panel Meters. DPM 102, 103, 112P, 201, 204, 301, 302, 303, 306, 343 Price and specs. on application
BIRD
Coaxial Resistor 8053 10W RF coaxial load resistor £20.00
Wattmeter Terminal 6935 3 ranges 0-120/0800/0-1200V 30-500 MHz £425.00
Wattmeter Terminal 67 3 ranges 0-25 / 0-100 / 0-500W / 30-500MHz £265.00

BRUEL & KJAER
Random Noise Generator 1402 £250.00
Automatic Vibration Exciter 1015 £495.00

GENERAL RADIO
Standard Frequency Multiplier 1112A Price & specs. on application
Standard Frequency Multiplier 1112B Price & specs. on application
MARCONI INSTRUMENTS
R.F. Power Meter TF152A/1 £80.00
Coor. Gain and Delay Test Set TF2904 625 line £505.00
R.F. Power Meter TF2502 3 and 10 watt ranges DC 1GHz £355.00
L.F. Extension Unit. TM8448 for use with OA 1094A series £200.00
RHODE & SCHWARZ
Standard Stereodecoder MSDC BN4193 £850.00
Polyscop I £950.00
Selektomat USWV £800.00
Frequency Indicator FKN £475.00
Type MSDC Standard Stereodecoder 30Hz-15KHz £850.00

Type MSC Stereodecoder BN4192/2 £1,250.00
RECORD
Chart Recorder - 500 µA Movement 1 in. 8.8 in. per hour £70.00
WAVETEK
Programmable Phase Meter 775 £795.00

CALIBRATORS & STANDARDS

FLUKE
Meter Calibrator 760A. Spec for DC Voltmeters - 0.001V to 1KV Accuracy 0.1% Resolution 100µV DC Ammeters - 3µA to 10A. Accuracy ±0.25% Resolution 1µA AC Voltmeters - 0.001V to 1KV 60Hz and 400Hz. Accuracy ±0.25% Resolution 100µV AC Ammeters - 1µA to 10A. 600Hz & 400Hz Accuracy ±0.25% Ohmmeters - 0 to 10M ohms ±0.1% of setting ±0.5M ohms. Resolution 1 ohm. Full spec on request. £2,150.00

Reference Divider 750A. Used for calibration of precision DC Voltmeters, Voltboxes, DC Calibrators etc. The equipment is a 10ppm (0.001%) divider with switched input taps ranging from 1100 to 1.1V & switched output taps ranging from 1100V to 0.1V £980.00

Null Detector 845A. All solid state. Designed for extremely high input impedances, sensitivity and isolation. Operates from either line or from built-in rechargeable batteries. 1µV through 100V DC and scale in 19 ranges using X1 and X3 progression. Full spec on request. £475.00

High Voltage Divider 805-10. Provides a highly stable, accurate means of measuring voltages up to 10KV in conjunction with differential voltmeters, d.v.m.s. and conventional potentiometers. Accuracy ±0.01% £285.00

FREQUENCY SYNTHESISERS

FLUKE
Frequency Synthesiser 6011A. Performs functions of an oscillator, counter and level meter. 10Hz-11MHz. Output 0.4mV-5V (r.m.s.) 7 digit LED display Accuracy ±3 parts in 10⁶ for one year. Freq. storage. Full Specification on request £2,650.00

Frequency Synthesiser B160A/DX. 4MHz-30MHz in 1Hz Steps. Output 1V into 50 ohms. Stability ±1 part in 10⁶ in 24 hours. Full Spec. on request. UN-USED. BARGAIN PRICE. £675.00

Shown on these pages are just a few samples of our huge stock. If the item you require is not shown please give us a ring.



Carriage and packing charge extra on all items unless otherwise stated

Please note: All instruments offered are secondhand and tested and guaranteed 12 months unless otherwise stated

Hours of business: 9a.m.-5p.m. Mon.-Fri. Closed lunch 1-2p.m.

OLSON**MINICASES**

Type	Overall Dimension			Case no vents	Case with vents	Chrome leg
	Width	Height	Depth			
21	6½"	4½"	4½"	—	4.75	1.00
22	8½"	5½"	5½"	—	5.35	1.00
23	10½"	6½"	6½"	—	6.35	1.05
24	12½"	7½"	7½"	—	6.95	1.05
25A	6½"	4½"	4½"	4.60	5.15	1.05
25B	6½"	4½"	6¼"	4.85	5.40	1.05
26A	8¾"	5¾"	6¼"	6.50	7.05	1.05
26B	8¾"	5¾"	8¼"	6.83	7.38	1.05
27A	12¼"	7½"	5½"	7.10	7.75	1.05
27B	12¼"	7½"	8"	7.70	8.35	1.05
28A	14"	10½"	6½"	8.40	9.05	—
28B	14"	10½"	8½"	9.13	9.78	—
29A	10"	4"	6"	5.88	6.43	1.05
29B	10"	4"	8"	6.20	6.75	1.05
30A	12"	5"	6"	6.40	7.05	1.05
30B	12"	5"	8"	6.70	7.35	1.05
31A	14"	6"	6"	7.00	7.65	1.05
31B	14"	6"	8"	7.35	8.00	1.05
61	15½"	7½"	9½"	—	10.60	—
62	17½"	8½"	9½"	—	12.35	—
63	16½"	9½"	9½"	—	12.35	—
64	15½"	7½"	12½"	—	12.35	—
65	17½"	8½"	12½"	—	14.00	—
66	16½"	9½"	12½"	—	14.00	—

C.R.T. TESTER/REACTIVATOR

Suitable for Monochrome or Colour. Tests, emission and inter electrode leakage. A three step reactivation facility to boost worn tubes.

£66 + V.A.T.

INSTANT TRUNKING SYSTEM!

Ready to use

Price **£21.50** + P. & P. & V.A.T.

Internal wiring suitable for 30 amp

PORTABLE POWER DISTRIBUTION FOR INSTANT MAINS!

COMPLETE WITH 6FT. CABLE AND 13 AMP FUSED PLUG

4 sockets 13A **£9.75**
 6 sockets 13A **£11.50**
 4 sockets 13A switched **£11.25**
 6 sockets 13A switched **£12.50**

ALL DISTRIBUTION PANELS ARE FITTED WITH MK SOCKETS & PLUG

ALL ITEMS + P & P + 8% V.A.T.

OLSON ELECTRONICS LTD., FACTORY NO. 8, 5-7 LONG ST., LONDON E2 8HJ
 TEL: 01-739 2343

WW-094 FOR FURTHER DETAILS

Design**Development****Prototype or
quantity production****Wound components
sub-assemblies****Professional or
consumer
applications****Design on our
capability**

Probably the best-equipped — and most experienced coil-windings specialists in Europe, Plessey Windings invites enquiries for all types of wound components and sub-assemblies.

**PLESSEY
WINDINGS**

Vicarage Lane, Ilford, Essex, England IG1 4AQ
 Telephone: (01) 478 3040. Telex: 23166.

More information, please,
about coil winding

Name _____

Company _____

Position _____

Telephone _____

Please call me

WW-084 FOR FURTHER DETAILS

7/ 612 PO75

Electronic Brokers The Computer People

STOP PRESS

ELLIOTT/ICL
PHOTOELECTRIC
PAPER TAPE READERS

250 cps operation. Compact table-mounting units consisting of lamp, driving motor, clutch electromagnet assembly, optical system, photosensor assembly and amplifier circuits. Power requirements: Lamp 9.5V, photosensors and amplifier circuits 6-10V.
PRICE: £165
Also available — high-speed models — 500 cps **£200** — 1,000 cps **£275**



Catalogue



Send for your free copy including latest update sheets

Mini-Computer Exchange



LATEST ARRIVALS:

PDP11-35 Processor with 96K parity core memory, memory management and expander box. 32K add-on parity core with backplane (MF11-UP + MM11-UP)
PDP8 Processors, 4K to 32K, various configurations available, prices from **£2,500**
PDP8 8K Processor and TTY interface **£1,750**
PDP8L 4K Processor and TTY interface **£950**
PDP8L Expander Box with 4K or 8K Memory enhancement, from **£750**
PDP11-05 Processors, 10 1/2" chassis, 8K or 16K core, prices from **£3,250**
PDP11/40 Processor, 28K core **£8,250**
RK08/RK05 Disk drive and control **£3,950**
RK05 16 sector disk packs **£30**
PR11 High speed reader complete with interface **£1,750**
RK11/RK05 Disk drive and control **£5,250**
PC11A Reader/punch and interface **£2,250**
RT02-AB Numeric data entry terminal with single line display **£150**

SPECIAL OFFER — ONLY A FEW LEFT!

DF32 Disc drive and control, only **£695**
DS32 Expander disk drive, only **£495**

DEC ADD-ON CORE:

MM8E 4K Memory stack **£600**
MM8EJ Memory stack **£1,300**
MC8EJ 8K Memory extension **£1,500**
MM11L 8K Memory stack **£1,000**
MM11L 8K Memory and backplane **£1,500**

DEC MODULES — PDP8E SERIES

K8E Positive I/O Bus **£275**
K8E Databreak **£350**
KL8E Serial Interface **£250**
KL8M Modem Control **£275**
KM8E Memory extension **£200**
KP8E Power fail/Auto restart **£175**
M8300 Major registers module **£550**
M8310 Registers Control **£285**
M8320 Bus Loads module **£82**
M8330 Timing Generator **£265**
M849 RFI Shield **£20**
M8E Bootstrap **£275**

DEC MODULES PDP11 SERIES

BM873YA Restart loader **£375**
BM792YL Bootstrap loader **£375**
DC11AC Dual Asynchronous interface **£750**
DL11C Serial Interface **£325**
H720E Expander Power Supply **£450**

Printers and Terminals

SUPER SAVINGS ON SPECIAL PURCHASE OF PORTABLE TEXAS SILENT 700 TERMINALS.

Our special price **£695**

Model 725 KSR ASCII Keyboard. Silent high speed operation up to 300 baud 5 x 7 dot matrix electronic printhead. Full or half duplex operation. Built in acoustic coupler. Mounted in integral carrying case. Gross weight 35lbs. Dimensions 21 1/2" x 19" x 5 1/2"



JUST RECEIVED — TEKTRONIX 611 STORAGE DISPLAYS

Prices from **£950**
11" Storage CRT. Vertical sensitivity 1V/16.2CM (sq. format) or 1V/21CM (rect format) within 2% FSD. Maximum input voltage — 50V DC and peak AC. Settling time 3.5 microseconds/cm + 5 microseconds. Stored resolution 4000 clearly legible characters (80 x 70mm) matrix) viewing time 15 minutes or less recommended for specified resolution.



FACIT PAPER TAPE PUNCHES

Special purchase of brand new surplus at big savings

FACIT 4070 75 CPS PUNCH

Self-contained table mounting unit with integral drive electronics plus tape supply and take-up spools

FACIT 4060 150 CPS PUNCH

with integral supply spool, complete with Facit 5107 control unit

OUR BARGAIN PRICE FOR THESE TOP QUALITY PUNCHES — £950 EACH

Also available — FACIT High-speed paper tape reader Model 4001. Reading speed up to 1000 cps. Integral supply spool. **£625**

LARGE STOCKS OF ASR33 AND KSR33 TELETYPE TERMINALS

- * ASCII Keyboard
- * Hard-copy unit (friction or sprocket paper/feeder)
- * Paper Tape punch and reader (ASR33 only)
- * Line Unit (20mA/6V/80V)

Overhauled in our own workshops to the highest standards and sold with 90 day warranty. Prices from **£425** (KSR 33) and **£625** (ASR33)

DIABLO Hi-type 1 daisy-wheel printer 30 cps (BRAND NEW, and offered complete with interface module for Data General processor) **Price £995**

IBM 731 and 735 INPUT/OUTPUT WRITERS

10 pitch golfball BCD or correspondence coding. 11 in. or 15 in. platen. Max. op speed 15 chps. **PRICES FROM £275.00**



Keyboards



KB8 REED-SWITCH KEYBOARD

- * 78 Station ASCII keyboard including separate numeric cluster, cursor control keys and 6 special function keys
- * Standard TTL logic
- * Power requirements + 5V @ 100mA and - 12V @ 4mA
- * 8-bit ASCII code (including parity) providing full 96-character set with upper and lower case outputs
- * Negative strobe with 4.0 ms delay

Overall dimensions 16 1/2 x 7 3/4 x 2 1/2". Supplied complete with full technical data and circuit diagrams. **PRICE £55 = £1.25 p&p + 8% VAT (Send £60.75).**



55SW3-1 54-station BCD-coded 4-bank alphanumeric keyboard.

Half-effect switches, input + 5VDC negative logic and strobed output, two key rollover. Set in attractive panel incorporating 5 indicator lamps and on/off switch. Dimensions 15 1/2 x 5 1/2 x 2 1/2". **PRICE £39.50 = £2 P&P + 8% VAT (Send £44.82).**

18-KEY PUSH-BUTTON CALCULATOR KEYBOARD

Numerals 0-9 decimal point C.K. = - X + = Mounted on PCB overall dimensions 5 1/2 x 4 1/2 x 1 1/2". **PRICE £4.00 = 50p P&P + 8% VAT (Send £4.86)**

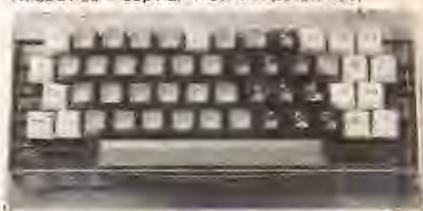

HONEYWELL KEYBOARDS

4-bank alphanumeric ex-equipment keyboards. 50 keystations, diode-encoded, 7-bit positive logic, positive strobe. TTL/DTL-compatible. Power requirements 5V, 100mA. Layout similar to IBM 029. **Price £25 = £1 P&P + 8% VAT (Send £28.08).**

*Teletype compatible *12" Diagonal Screen *TTY Format Keyboard *64 ASCII Character Set *5 x 7 Dot Matrix *Switch-Selectable Transmission Rate up to 9600 baud *Switch-Selectable Parity *Standard CCITT V.24 Interface

HAZELTINE 2000 Superb buffered terminal with full edit facilities, 1988 character capacity (27 lines of 74), detachable ASCII keyboard including 10-key numeric pad and 13-key cursor control cluster. Selectable transmission, full/half duplex or batch.
New List Price £1649
OUR PRICE £895

SAVE up to 45% on HAZELTINE World Leaders in CRT Terminals

HAZELTINE 1000 Compact terminal providing 12 line by 80 character display (960 chs.), full/half duplex, MOS SHIFT REGISTER MEMORY WITH CONSTANT REFRESH. Underline cursor.

New List Price £900
NEW LOW PRICE £495

ALL UNITS FACTORY-REFURBISHED TO AS-NEW STANDARD AND COVERED BY 90-day warranty

HAZELTINE 1200 All the features of the Model 1000 but with double screen capacity of 1920 characters (24 lines of 80). Reverse block image cursor.

New List Price £941
OUR PRICE £725

ELECTRONIC BROKERS LIMITED

49-53 Pancras Road, London NW1 2QB. Tel. 01-837 7781. Telex: 298694

Hours of business:
9 a.m.-5 p.m. Mon.-Fri. Closed lunch 1-2 p.m.

ADD 8% VAT
TO ALL PRICES

Carriage & Packing charge extra
on all items unless otherwise stated

WW-078 FOR FURTHER DETAILS



WILMSLOW AUDIO

The firm for Speakers

HI-FI DRIVE UNITS



PA GROUP & DISCO UNITS



WILMSLOW AUDIO

KITS FOR MAGAZINE DESIGNS etc.



SPEAKER KITS



Audax HD12.9 D25	£7.50
Audax HD20B25J4	£10.95
Audax HD11 P25EBC	£6.95
Baker Superb	£22.50
Castle 8RS/DD	£9.95
Coles 4001	£5.90
Coles 3000	£6.25
Celestion HF1300 II	£7.50
Celestion HF2000	£9.75
Dalesford D20/105 4"	£9.95
Dalesford D30/110 5"	£9.95
Dalesford D50/513 6 1/2"	£10.95
Dalesford D50/200 8"	£10.95
Dalesford D70/250 10"	£24.95
Dalesford D100/310 12"	£30.95
Decca London	£37.26
Decca CG/1000/8	£7.95
Decca DK30	£24.50
Elac TW3/04	£2.95
Elac GRM171	£4.35
Elac 6NC204	£6.50
Elac 6NC298 d/c	£6.75
Elac 6NC245 bass	£5.65
E.M. 14A/770 14" x 9"	£12.50
E.M. 8" x 5" d/c 10 watt	£3.95
Goodmans Axent 100	£8.50
Goodmans Twinaxiom 10" 80	£10.95
Isophon KK10/B	£8.25
Isophon KK8/8	£7.50
Jordan Watts Module	£17.95
Jordan 50mm Unit	£22.50
Jordan CB Crossover	£22.50
KEF T27	£8.50
KEF T15	£10.75
KEF B110	£10.95
KEF B200	£11.95
KEF B139	£24.95
KEF DN13	£4.95
KEF DN12	£7.25
Lowther PM6	£39.95
Lowther PM6 MKI	£42.95
Lowther PM7	£78.95
Peerless DT10HFC	£9.50
Peerless KO10DT	£8.25
Peerless KO40MRF	£10.50
Radford BD25 II	£26.95
Radford MD9	£14.50
Radford MD6	£17.95
Radford FN8/FN831	£19.95
Richard Allan CG8T	£8.95
Richard Allan CG12T Super	£19.50
Richard Allan HPBB	£13.50
Richard Allan LPBB	£9.25
Richard Allan HP12B	£21.50
Richard Allan DT20	£6.25
Richard Allan OT30	£6.95
Tannoy HPD 295A	£83.00
Tannoy HPD 315A	£93.00
Tannoy HPD 385A	£110.00

Baker Group 25	£13.00
Baker Group 35	£14.50
Baker Group 50/12	£21.00
Baker Group 50/15	£25.75
Baker Auditorium 12"	£21.00
Baker Auditorium 15"	£25.75
Celestion G12M	£12.95
Celestion G12H	£16.95
Celestion G15C	£27.95
Celestion G18C	£39.95
Celestion G12/50 2244/5	£21.95
Celestion G12/50 2235/6	£19.95
Celestion G12/50 2238/9	£20.50
Celestion G12/50 2241/2	£21.50
Celestion Powercell 12"/100	£43.95
Celestion Powercell 15"/100	£46.95
Celestion Powercell 15"/125	£49.95

Fane Pop 33T	£10.95
Fane Pop 50	£12.50
Fane Pop 55	£16.95
Fane Pop 60	£19.95
Fane Pop 70	£21.95
Fane Pop 100	£35.95
Fane Guitar 80L	£19.75
Fane Guitar 80B	£19.95
Fane Disco 80	£21.50
Fane PA80	£19.50
Fane Bass 85	£29.95
Fane Crescendo 12A	£42.95
Fane Crescendo 12B	£44.95
Fane Crescendo 15/100	£54.95
Fane Crescendo 15/125	£64.95
Fane Crescendo 18	£75.95
Fane 920 II Horn	£45.95
Fane HPX1/HPX2	£2.50
Fane PH50	£7.50

Goodmans 8PA	£3.95
Goodmans 10P	£6.95
Goodmans 12P	£16.95
Goodmans 12PD	£18.95
Goodmans 12PG	£18.25
Goodmans 15P	£24.00
Goodmans 18P	£39.95
Goodmans 50HX	£18.95

Motorola Piezo Horn £8.50

Richard Allan HD8T	£12.95
Richard Allan HD10T	£13.25
Richard Allan HD12T	£18.75
Richard Allan HD15	£29.95
Richard Allan HD15T	£30.50

Kits include drive units, crossovers, BAF/Long fibre wool, etc. for pair of speakers. Carriage £3.50.

Practical HiFi & Audio PRO9 TL (Rogers) £118
Felt panels for PRO9-TL £5.50 + £1.50 p&p

HiFi Answers Monitor (Rogers) £129

HiFi News State of the Art (Atkinson) £161

HiFi News No Compromise (Frisby) £126

Popular HiFi Mini Monitor (Colloms) £63

Practical HiFi & Audio Monitor (Giles) £119

Practical HiFi & Audio Triangle (Giles) £76

HiFi News Tabor (Jones) £57.75

HiFi News Tabor (with H4 bass units) £65

Wireless World Bookshelf (Wilkinson) £56.50

Wireless World T.L./KEF (Bailey) £112

Wireless World T.L./Radford (Bailey) £154

Send 3 x 7p stamps for reprints / construction details of any of above designs.

CARRIAGE & INSURANCE

Tweeters/Crossovers	40p each
Speakers up to 10"	75p each
Speakers 12"	£1.25 each
Speakers 15"	£2.00 each
Speakers 18"	£2.95 each
Speaker Kits	£2.50 pair
Mag. design kits	£3.50 pair

Prices per pair. Carriage £2.50.

Dalesford System 1	£51.50
Dalesford System 2	£53.75
Dalesford System 3	£89.75
Dalesford System 4	£106.00
Dalesford System 5	£131.00
Dalesford System 6	£91.00

Eagle SK210	£13.90
Eagle SK215	£23.50
Eagle SK320	£33.50
Eagle SK325	£51.00
Eagle SK335	£65.90

Goodmans DIN20	£31.50
Goodmans Mezzo Twinkit	£51.95

Lowther PM6 Kit	£81.75
Lowther PM6 MKI Kit	£86.95

Peerless 1060	£61.50
Peerless 1070	£109.90
Peerless 1120	£123.00
Peerless 2050	£43.95
Peerless 2060	£58.50

Radford Studio 90	£154.00
Radford Monitor 270	£208.00
Radford Studio 270	£275.00
Radford Studio 360	£390.00
Richard Allan Twin	£29.90
Richard Allan Triple 8	£45.50
Richard Allan Triple 12	£55.90
Richard Allan Super Triple	£65.90
Richard Allan RA8	£42.75
Richard Allan RA82	£67.75
Richard Allan RA82L	£73.50

Seas Mini	£21.95
Seas 203	£35.50
Seas 302	£43.90
Seas 303	£73.90
Seas 503	£111.90

Wharfedale Denton 2XP	£26.95
Wharfedale Linton 3XP	£41.95
Wharfedale Glendale 3XP	£56.95

Everything in stock for the speaker constructor!
BAF, long fibre wool, foam, crossovers, felt panels, components etc
Large selection of grille fabrics (Send 15p stamps for samples)
(Prices correct at 3/11/77)

SWIFT
OF WILMSLOW
The firm for Hi-Fi
5 Swan Street,
Wilmslow, Cheshire.

Send 15p stamp for free 38 page catalogue 'Choosing a Speaker'

Telephone: Speakers, Mail Order and Export:
Wilmslow 29599 Hi-Fi: Wilmslow 26213

Lightning service on telephoned credit card orders!

**WILMSLOW
AUDIO**
The firm for Speakers

Swan Works, Bank Square,
Wilmslow, Cheshire.

DIY SPEAKER KITS

15-WATT KIT IN CHASSIS FORM

When you are looking for a good speaker, why not build your own from this kit. It's the unit which we supply with the enclosure illustrated below Size 13" x 8" (approx.) woofer (EMI), tweeter, and matching crossover components. Power handling capacity 15 watts rms, 30 watts peak.

£17.00 PER STEREO PAIR + P & P £3.40

EASY-TO-BUILD WITH ENCLOSURE

Specially designed by RT-VC for cost-conscious hi-fi enthusiasts, these kits incorporate two teak-simulate enclosures, two EMI 13" x 8" (approx.) woofers, two tweeters and a pair of matching crossovers. Easily constructed, using a few basic tools. Supplied complete with an easy-to-follow circuit diagram, and crossover components. Input 15 watts rms, 30 watts peak, each unit. Cabinet size 20" x 11" x 9" (approx.).

£28.00

PER STEREO PAIR + P & P £5.50

COMPACT* FOR TOP VALUE

How about this for incredible bookshelf value from RT-VC! A pair of high efficiency units for only £8.50 — just what you need for low-power amplifiers. These infinite baffle enclosures come to you ready milled and professionally finished. Each cabinet measures 12" x 9" x 5" (approx.) deep, and is in wood simulate. Complete with two 8" (approx.) speakers for max. power handling of 7 watts.

per stereo pair
£8.50
+ P & P £2.20

SPEAKERS Two models — Duo III, teak veneer, 12 watts rms, 24 watts peak, 18 1/2" x 13 1/2" x 7 1/2" (approx.).

£17 PER PAIR + P & P £6.50

Duo III, 20 watts rms, 40 watts peak, 27" x 13" x 11 1/2" (approx.)
£52 PER PAIR + P & P £7.50

EASY TO BUILD RECORD PLAYER KIT

Ideally suited for the constructor who requires a complete stereo unit at a budget price, comprising ready assembled stereo amp, module, Garrard auto/manual deck with cueing device, pre-cut and finished cabinet work. Output 4 watts per channel, phono socket and record/replay socket.

£26.95
P & P £4.05

CAR RADIO KIT

Complete with speaker, baffle and fixing strip. The Tourist IV for the experienced constructor only. The Tourist IV has five push buttons, four medium band and one for long wave band. The tuning scale is illuminated and attractive small aluminium control knobs are used for manual tuning and volume control. The modern style fascia has been designed to blend with most car interiors and the finished radio will slot into a standard car radio aperture. Size approx. 7" x 2" x 4 1/2". 12 watts pos or neg earth (entered internally) P & P £1.50

Output 4 watts into 4 ohms.
FREE TO PERSONAL SHOPPERS BUYING CAR RADIO KIT. ELECTROMATE Rear window heater cable. Link element all wiring and switch work £3.00



20 x 20 WATT STEREO AMPLIFIER

Superb Viscount IV unit in teak-finished cabinet. Silver fascia with aluminium rotary controls and pushbuttons, red mains indicator and stereo jack socket. Function switch for mic, magnetic and crystal pick ups, tape, tuner, and auxiliary. Rear panel features two mains outlets, DIN speaker and input sockets, plus fuse. 20 + 20 watts rms, 40 + 40 watts peak.

£29.90
+ P & P £2.50

FREE To cash or cheque personal shoppers
A 4 channel Stereo Adaptor to all buyers of the Viscount 20 x 20 Amplifier at £29.90 limited offer. Available separately at £3.95 + P & P £1.00

- STEREO CASSETTE** record/replay fully built P.C. board incorporating 4 I.C.s, used without glue, £1.95
- PAIR STEREO 8 WATT SPEAKERS** 8" bass units with 3 1/2" approx. tweeters power handling 8 watts imp Behms. Size 16 1/2" x 11" x 3 1/2" approx. £12.95
- SLIMLINE RECORD PLAYER PLINTH**, accepts BSR Turntable GOODMAN 5" approx. 7 watt bare speaker £9.50
- AM. FM. TUNER P.C.B.** with Mullard I.P. 1188, 1185, 1187 valves £9.50
- 100K Multiturn Variable tuning pots** for HEAVY DUTY FIBRE GLASS COPPER CLAD BOARD 25" x 17" x 1/4" approx. per sheet only £1.00
- BECCA 201001 Stereo Cassette Record deck P.C.B.** complete with switch coilformer coils and tape heads and circuit diagrams. £2.95
- AM. FM. STEREO MULTIPLEX CAR RADIO/cassette player** in dash fitting Negative earth 5 watts output I.C. Stereo 3 Track to Cassette adaptor converts any 3 track player to cassette player. £36.00
- NATIONAL PANASONIC AM stereo auto-reverse car cassette player model No. CQ181EM.** Lot 5124. Car Price £24.95
- JAVELIN "MINI" AUTO-EJECT CASSETTE CAR STEREO PLAYER.** Model No. 21110. Car Price £8.95
- 4 DIGIT ELECTRONIC CLOCK**, with alarm. AC240V. Only £19.95
- AM 4 DIGIT ELECTRONIC CLOCK RADIO** with alarm, sleep and snooze. Only £19.95
- GARLTON STEREO CASSETTE TAPE DECK** with CD22 auto level control. Twin 1/2" outputs. Car Price Only £41.95

ADD-ON STEREO CASSETTE TAPE DECK KIT
Designed for the experienced D.I.Y. man. This kit comprises of a tape transport mechanism, ready built and tested record/replay electronics with twin V.U. meters and level control ready for mating together with the mechanism.
Specifications: Sensitivity — Mic. 0.85mV ± 20K OHMS. Din. 40mV ± 400K OHMS. Output — 300mV RMS per channel ± 1KHz from 2K OHMS source. Cross Talk — 30db. Tape Counter — 3 Digit. Resetttable. Frequency Response — 40Hz — 8KHz ± 6db. Deck Motor — 9 Volt DC with electronic speed regulation. Key Functions — Record, Rewind, Fast Forward, Play, Stop & Eject. P & P £2.50

Pair of Dynamic microphones £3.95 + P & P £1.00
Mains transformer £2.50 + P & P £1.00

BSR TURNTABLES
BSR automatic record player deck (Chassis form) with cueing device and stereo ceramic head. P & P £2.55

TURNTABLE illus. diamond stylus, and de luxe plinth and cover. Ready wired. £29 P & P £4.50

Popular BSR MP 60 type, complete with magnetic cartridge. £4.95

CERAMIC STEREO £1.95

30 x 30 WATT AMPLIFIER KIT
Specially designed by RT-VC for the experienced constructor, this kit comes complete in every detail. Same facilities as Viscount IV amplifier. Chassis is ready punched, drilled and formed. Cabinet is finished in teak veneer. Silver fascia and easy-to-handle aluminium knobs. Output 30 + 30 watts rms, 60 + 60 peak. £29.00 P & P £2.50

NOW AVAILABLE fully built and tested. £35.00 P & P £2.50

DECCA 20 WATTS STEREO SPEAKER
This matching loudspeaker system is hand made, kit comprises of two 8" diameter approx base drive unit, with heavy die cast chassis laminated cones with rolled P.V.C. surrounds, two 3 1/2" diameter approx. domed tweeters comp with crossover networks £4.00 P & P stereo pair £20.00

Indicating your credit card number ONLY
ALL PRICES INC. VAT AT 12 1/2%
13277
Send stamped addressed envelope for further details.

RTVC
323 EDGWARE RD., LONDON, W2. Tel. 01-723 8432
21 (E) HIGH STREET, ACTON, LONDON W3 6NE
ACTON: Mail Order only No callers.

PORTABLE MONO DISCO

with built-in pre-amplifiers
Here's the big-value portable disco console from RT-VC! It features a pair of BSR MP 60 type auto-return, single play professional series record decks. Plus all the controls and features you need to give fabulous disco performances. Simply connects into your existing slave or external amplifier.

£64.00

45 WATT MONO DISCO AMP

Size approx. 13 1/2" x 5 1/2" x 5 1/2"
Here's the mono unit you need to start off with. Gives you a good solid 45 watts rms, 50 watts peak output. Big features include two disc inputs, both for ceramic cartridges, tape input and microphone input. Level mixing controls fitted with integral push-pull switches. Independent bass and treble controls and master volume.

70 & 100 WATT MONO DISCO AMP

Size approx. 14" x 4" x 10"
Slipping fascia, you can use the controls without fuss or bother. Brushed aluminium fascia and relay controls. Five smooth acting, vertically mounted slide controls — master volume, tape level, mic level, deck level, PLUS INTER-DECK FADER for perfect graduated change from record deck No. 1 to No. 2, or vice versa. Pre-fade level control (PFL) lets YOU hear next disc before fading 70 watt it in. VU meter monitors output level. 100 watt Output 100 watts RMS 200 watts peak. P & P £4.00

BSR 80595 TYPE
Belt drive turntable unit. 7 speed, semi automatic operation. £24.95 + P & P £7.55

PRACTICE GUITAR AMPLIFIER WITH BUILT-IN SPEAKER

This budget practice amplifier, has been specially designed for the amateur, who requires a quality self contained unit with all facilities. 2 inputs — 1 for mic or guitar, the 2nd for record player or cassette deck. It also can be used for line sound amplification. 2 volume controls, 1 for each input, also bass and treble controls. Power output with internal speaker. 10 watts RMS, with remote speaker (not supplied) 20 watts RMS. Size approx. 17" x 9" x 11" P & P £3.00

HOME 8 TRACK CARTRIDGE PLAYER

Automatically switches programmes monitored by indicators, with manual override track selection. This unit will match with the Unisound modules and is compatible with the Viscount IV amplifier with Sim 100k cabinet approx. 8" x 8" x 3 1/2" P & P £2.50

PYE STEREO GRAM CHASSIS

(Complete with circuit diagrams)
Complete ready to install — Wave bands LM, VHF STEREO, VHF MONO. Controls for tuning volume balance, bass and treble. Power output 7 watts R.M.S. per channel 14 watts peak 3 ohms. 2" x 8" approx chassis speakers and BSR auto record player deck. PERSONAL SHOPPERS ONLY £35.00

BENTLEY ACOUSTIC CORPORATION LTD.

7A GLOUCESTER ROAD, LITTLEHAMPTON, SUSSEX. Tel. 6743
ALL PRICES SHOWN INCLUDE V.A.T. AT 12 1/2 %

WAG	0.45	WAG	0.75	WAG	0.50	WAG	0.52	WAG	0.55	WAG	0.58	WAG	0.60	WAG	0.62	WAG	0.65	WAG	0.68	WAG	0.70	WAG	0.72	WAG	0.75	WAG	0.78	WAG	0.80	WAG	0.82	WAG	0.85	WAG	0.88	WAG	0.90	WAG	0.92	WAG	0.95	WAG	0.98	WAG	1.00	WAG	1.02	WAG	1.05	WAG	1.08	WAG	1.10	WAG	1.12	WAG	1.15	WAG	1.18	WAG	1.20	WAG	1.22	WAG	1.25	WAG	1.28	WAG	1.30	WAG	1.32	WAG	1.35	WAG	1.38	WAG	1.40	WAG	1.42	WAG	1.45	WAG	1.48	WAG	1.50	WAG	1.52	WAG	1.55	WAG	1.58	WAG	1.60	WAG	1.62	WAG	1.65	WAG	1.68	WAG	1.70	WAG	1.72	WAG	1.75	WAG	1.78	WAG	1.80	WAG	1.82	WAG	1.85	WAG	1.88	WAG	1.90	WAG	1.92	WAG	1.95	WAG	1.98	WAG	2.00
-----	------	-----	------	-----	------	-----	------	-----	------	-----	------	-----	------	-----	------	-----	------	-----	------	-----	------	-----	------	-----	------	-----	------	-----	------	-----	------	-----	------	-----	------	-----	------	-----	------	-----	------	-----	------	-----	------	-----	------	-----	------	-----	------	-----	------	-----	------	-----	------	-----	------	-----	------	-----	------	-----	------	-----	------	-----	------	-----	------	-----	------	-----	------	-----	------	-----	------	-----	------	-----	------	-----	------	-----	------	-----	------	-----	------	-----	------	-----	------	-----	------	-----	------	-----	------	-----	------	-----	------	-----	------	-----	------	-----	------	-----	------	-----	------	-----	------	-----	------	-----	------	-----	------	-----	------

ALL PRICES INCLUDE V.A.T. NOTHING EXTRA TO PAY

NEW! STUNT TV MAN

4 EXCITING MOTORBIKE TV GAMES

Normal and Super Rider Modes at the flick of a switch.
Realistic Throttle and Crash sound effects from the TV Loudspeaker.

A GAME YOU'LL NEVER BE TIRED OF PLAYING

Super Stunt Cycle

Drag Race

Stunt Cycle

Motocross

HOW MANY BUSES CAN YOU JUMP?

This simple to assemble (1 hour) TV Game Kit comes complete (No extras needed) - just simple soldering. Expected retail price (when available in shops) - over £55.00. SAVE 50% by building it yourself. Be one of the first in Europe with this new stunt cycle craze at £28.50 (inc. VAT) + 25p P & P.

Make all cheques or postal orders payable to Teleplay.
Mail Orders: 53 Warwick Road, New Barnet, Herts. EN5 5EQ.
Retail Shop and Demonstrations - 14 Station Road, New Barnet, Herts.
For further Details and Technical Help - phone 01-441 2922.
For extra speed phone your order on Barclay or Access Cards.

(Franch and German spoken)

teleplay

CLICK

Light on the scene.
Local lighting just where you want it with Click's elegant, adjustable Spotlight or snake-arm Reading Lamp.

Tidy wires.
With Click you can hide all your leads and wires inside the uprights, with a neat, snap-in cover strip.

Keeping it steady.
With shelves fixed firmly to the wall, you eliminate floor vibration problems.

Finding a level.
Click brackets are infinitely adjustable for height so you can always get your shelves level.

Shelving for hi-fi.

We've solved the problems.

FREE Post this ad. with your name and address for a 10-page leaflet to Click Shelving Ltd.
Lowmoor Rd, Kirkby in Ashfield, Notts. NG17 7LH

Edicron

For Quality and Reliability

Edicron Limited
Redan House 1 Redan Place
London W2 4SA
Tel: 01-727 0101
Telex: 265531
Cables: Edicron London W2

Electronic Valves/Tubes

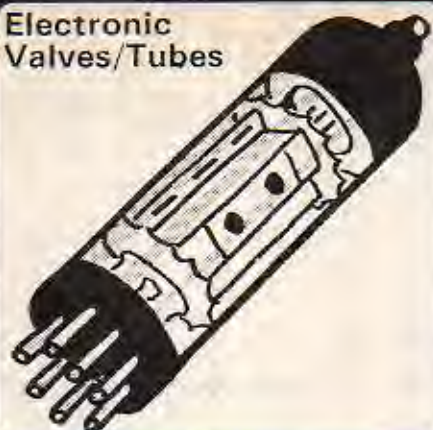

Resistors and Capacitors

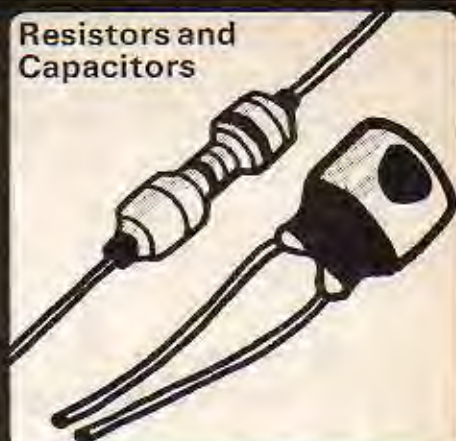

TV Picture Tubes

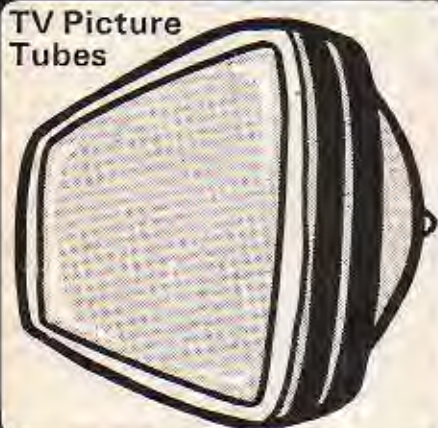

Transistors

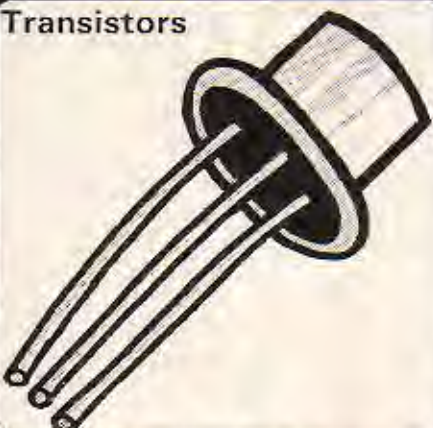

CR Gun Assemblies



EXPORT — INDUSTRY — WHOLESALE

WW — 095 FOR FURTHER DETAILS

MARGONI TEST EQUIPMENT

TF329G circuit magnification meter £125
TF455E Wave analyser. New. £135
TF1101 RC oscillators. £65
TF1099 20MHz sweep generators
TF1041B & C. VT Voltmeters
TF1102 Amplitude modulator. 500MHz
TF1020A Power meter. 100W. 250MHz. £85
TF1152A/1 Power meter. 25W. 500MHz. £75
TF890A/1 RF test set. £425
TF801B/35 Signal generator. £175
TF1417 200MHz counter (imperfect)
TF1400 Pulse generator
TF675F Pulse generator
TF1370 Wide-range RC oscillator £125
TF2904 Colour gain delay test set
TF1058 UHF/SHF signal generator
Zenith 8 Amp variacs. £28.50 (carr. 150p)

ADVANCE CONSTANT VOLTAGE TRANSFORMERS

Input 190-260V AC. Output constant
220 Volts. 250W. £25 (E2 carriage)

POLARAD TYPE TSA. SPECTRUM ANALYSER. C/w type STU/2M plug-in unit covering from 950 to 4500 MHz.

EVER-READY NICKEL CADMIUM BATTERIES

Size "F". 7.0Ah. 1.24 Volts. £2.75 (post 25p)
SONNENSCHNEIN DRYFIT BATTERIES
12 Volts 7.5 A.H. £4.50 (post 50p)
8 Volts 5.7 A.H. £7.00 (post 50p)

APT POWER SUPPLIES. Stabilised and regulated 6V (variable) at 3A. Brand new. £25.

BECKMAN TURNS COUNTER DIALS

Miniature type (22mm diam.) Counting up to 15 turn "Helipot". Brand new with mounting instructions. Only £2.50 each
Wandel & Gottman Equipment
Level Meter 0.2-1600KHz
Level Oscillator 0.2-1600KHz
Level Transmitter .3-1350 KHz
Carrier Frequency Level Meter

P. F. RALFE ELECTRONICS

10 CHAPEL STREET, LONDON, NW1
TEL: 01-723 8753

TEST EQUIPMENT

LEADER TV FM Sweep and marker generator
SOLARTRON CD1400. DC-15MHz oscilloscope
AIRMEC 254 High-power oscillator/amplifier
BOONTON 80 Signal generator. 2-400MHz. £105
BOONTON 230A RF Power Amplifier. £325
BPL Capacitance decade (5) CD133. 100pf-1uF. £45
GERTSCH Frequency meter and deviation meter 20-1000MHz £250
GR Standard sweep generator. 400KHz-230MHz £485
HEWLETT PACKARD 693D sweep oscillator £350
DERRITON. Digital Wheatstone Bridge £110
MUIRHEAD K-134-A Battery op. wave analyser
PYE EHT scalamp voltmeter 0-40KV £125



RADIO CORPS PB1 pulse & bar generator £45
SIEMENS Level oscillator 12-160KHz
SCHNEIDER type ci252 100MHz counter (red) £200
SCHOMANDL type FD1 frequency meter £125
HEWLETT-PACKARD 180A 50MHz DB. Oscilloscope
Bruel & Kjoer type 3301 Automatic Frequency Response Recorder 200Hz-20KHz
Airmec 201A Signal Generator 30KHz-30MHz.
MUIRHEAD-PAMETRADA D489EM Wave Analyser
TEKTRONIX 555 scope with plug-ins types CA (2 off), 21 and 22
TEKTRONIX 545 main frames. £210. Choice of plug-in units extra.
TEKTRONIX 585A oscilloscope with '82' P.I. DC-60MHz £580
TEKTRONIX type 525 Vectorscope £110
TEKTRONIX type 180A Time-mark generator £110
WANDEL & GOTTMAN Signal Gen. 10Hz-30MHz

NOTICE. All the pre-owned equipment shown has been carefully tested in our workshop and reconditioned where necessary. It is sold in first-class operational condition and most items carry our three months' guarantee. Calibration and certificates can be arranged at cost. Overseas enquiries welcome. Prices quoted are subject to an additional 8% VAT.

RÖHDE & SCHWARZ EQUIPMENT

HUZ Field Strength Meter. 47-225MHz.
AMF TV. Demodulator 470-790MHz.
Selective UHF v/meter. bands 4&5. USVF.
Selectomat. RF Voltmeter. USWV. BN 15221 £450
Standard attenuator. 0-100db. 0.300 mHz. DPR.
UHF Sig. gen. type SDR 0.3-1 GHz. £750
UHF Signal generator type SCH. £175
UHF Test receiver type USVD. £325
POLYSKOP SWOB I.

PAPER TAPE READERS

Tally model 1806. £150.
NCR with sound-proof case £55

TEKTRONIX TYPE 561A OSCILLOSCOPES

Supplied in first-class condition complete with types 3A1 and 3B3 plug-in units. DC-10MHz double-beam 10mV/div. Calibrated sweep delay and single-shot. Time-base 0.5us/div. £350.00

MUFFIN INSTRUMENT COOLING FANS

Made by Rotron Holland. These are very high quality, quiet running fans, specially designed for the cooling of all types of electronic equipment. Measures 4.5x4.5x1.5". 115V AC. 11 Watts. The list price of these is over £10 each. We have a quantity available brand new for only £4.50 each

500V TRANSISTORISED INSULATION TESTER

Lightweight, small size (13x7x4cms). Reads insulation from 0.2-100MΩ at 500V pressure. Runs from standard 9V PP3. Brand new. £16.50

TELEVISION MONITORS

Philips studio quality precision colour monitors and Pye monochrome 405/525/825 lines

PACE ELECTRONICS VARI PLOTTER

Type 1100E £175

MUIRHEAD DECADE OSCILLATORS type 890A.

1Hz-110kHz in four decade ranges. Scope monitored output for high accuracy of frequency. Excellent generator.

Appointments

Advertisements accepted up to 12 noon Monday, January 30, for the March issue, subject to space being available.

DISPLAYED APPOINTMENTS VACANT: £7.50 per single col. centimetre (min. 3cm).
LINE advertisements (run on): £1.10 per line, minimum three lines.
BOX NUMBERS: 50p extra. (Replies should be addressed to the Box Number in the advertisement. c/o Wireless World, Dorset House, Stamford Street, London SE1 9LU.)
PHONE: Eddie Farrell on 01-261 8508
 Classified Advertisement Rates are currently zero rated for the purpose of V.A.T.

Land a good job

Your
 Radio Officer's
 qualifications
 can mean a lot
 here on shore

If you're thinking of a shore-based job, here's where you'll find interesting work, job security, good money, and the opportunity to enjoy all the comforts of home where you appreciate them most - at home!

The Post Office Maritime Service has vacancies at Portishead Radio and some of its other coast stations for qualified Radio Officers to undertake a wide variety of duties, from Morse and teleprinter operating to traffic circulation and radio telephone operating.

To apply, you must have a United Kingdom Maritime Radio Communication Operator's General Certificate or First Class Certificate of Proficiency in Radio-telegraphy or an equivalent certificate issued by a

Commonwealth Administration or the Irish Republic. And, ideally, you should have some sea-going experience.

The starting pay at 25 or over works out at around £4093; after three years' service this figure rises to around £5093. (If you are between 19 and 24 your pay on entry will vary between approximately £3222 and £3732). Overtime is additional, and there is a good pension scheme, sick-pay benefits, at least 4 weeks' holiday a year, and excellent prospects of promotion to senior management.

For further information, please telephone Andree Trionfi on 01-432 4869 or write to her at the following address: ETE Maritime Radio Services Division (L690), ET17.1.2, Room 643, Union House, St. Martins-le-Grand, London EC1A 1AR.

Post Office Telecommunications

Electronics Maintenance Technician

(Male or female) for a department responsible for the repair of the Laboratories' professional electronic equipment. This involves the maintenance of oscilloscopes, precision high power magnet controllers, digital equipment such as D.V.M.'s, counters, pulse generators and analysers of various kinds.

Experience of servicing this type of equipment is required and it is hoped to gradually

extend the maintenance capability to include microprocessors, computers and associated peripherals.

Please apply for an application form to: Mr. M. L. Malpass, Personnel Manager, Philips Research Laboratories, Cross Oak Lane, Salfords, Redhill, Surrey. Tel: Horley 5544. Quoting reference: 102.



Research
 Laboratories

PHILIPS

7834

University of Wales

UWIST

**DEPARTMENT OF PHYSICS
 ELECTRONICS AND
 ELECTRICAL ENGINEERING**

**M.Sc./DIPLOMA
 COURSE
 IN ELECTRONICS**

Applications are invited for places in the full-time one-year MSc/Diploma course in Electronics, commencing 27 September 1978.

Further details and application forms (returnable as soon as possible) may be obtained from the Academic Registrar, UWIST, Cardiff CF1 3NU.

7823

DESIGN/DEVELOPMENT ENGINEERS

Ferranti wins Army contract.

Ferranti land space order.

**1200 MORE JOBS FOR
FERRANTI EXPANSION**

MoD order goes to Ferranti.

Come and make headlines with us.

Headlines like these are only possible when you're acknowledged internationally as one of the world's leaders in avionics. To keep us at the forefront we need highly motivated design/development engineers keen to make their mark. And at Ferranti there's plenty of opportunity to do just that. On projects like the Tornado, Sea Harrier, Jaguar and Lynx.

And headlines like these also mean expansion. Which explains why we're looking for more graduate mechanical and electronic engineers to join our airborne radar and inertial navigation teams. They must have the design/development experience to spearhead the progress of equipment from drawing board through to production.

We are particularly interested in talking to engineers with backgrounds in the design of:-

Digital/analogue circuitry.

Microwave and laser techniques.

Small digital computers.

Advanced instruments.

Optics.

Airborne structures and light mechanisms.

So if you're keen to make your mark on avionics, you'll find you're very much on our wavelength.

Think about it. Then ask the family how they'd like living in Edinburgh, freely acknowledged as one of Europe's finest cities.

Salaries are negotiable and, of course, we operate a contributory pension and life assurance scheme and pay realistic relocation expenses.

For an application form, write to John McPhee at the address below:

**Ferranti Limited
Ferry Road
EDINBURGH EH5 2XS
Tel: 031-332 2411.**

These posts are open to both male and female candidates.

17000

FERRANTI

Challenging Opportunities in Brunei's New Colour Television Service

Radio Television, Brunei commenced operations in 1975 as the first all colour television service in South East Asia. During 1978 it is expected that a completely new purpose-built 3 studio colour television complex will be brought into operation. Television standards are PAL, System S. To assist with the additional staffing requirements for this complex, applications for the following posts in the television studio centre in Bandar Seri Begawan are invited from candidates with at least 6 years' experience working professionally in a television service in a senior capacity. Relevant engineering qualifications are desirable but not essential.

Supervisory Engineer

Candidates should have a wide experience of video systems engineering and preferably be familiar with EMI type 2005 cameras, AVR2 Ampex recorders and Rank Cintel film scanning equipment. Working to the Superintendent Engineer, he will be responsible for the general supervision of all television studio operations.

Two Training Officers

One officer will be required to train local staff in all aspects of audio operations in both radio and television, while the other will be responsible for video operations. In addition to wide experience in television technical operations, candidates with some teaching experience will be given preference.

Salaries are in a scale equivalent to £8870-£9505 pa, tax free including special allowance, and attract 25% gratuity.

Benefits include first-class air travel for the officer and his family, subsidised housing, generous paid leave, education allowances, outfit allowance, interest free car loan and free medical attention. Appointment is on contract terms for 2 or 3 years.

For full details and application form write quoting MT/832/WD.

Crown Agents

The Crown Agents for Oversea Governments and Administrations, Appointments Division,
4 Millbank, London SW1P 3JD.

(7814)

APPOINTMENTS IN ELECTRONICS

Take your pick of the permanent posts in:

MISSILES — MEDICAL
COMPUTERS — COMMS
MICROWAVE — MARINE
HARDWARE — SOFTWARE

For expert advice and immediate action on career improvement, phone, or write to, Mike Gernat BSc.

Technomark
Engineering and Technical Recruitment

11 Westbourne Grove
London W2. 01-229 9239.

7098

NEWCASTLE AREA HEALTH AUTHORITY (TEACHING) Area Supplies Division

EQUIPMENT FOR DISPOSAL

Eight U.E.L. Cub hand-portable sets (1968), 0.5 watt, 171.35 MHz, with base station and antenna; in working order (new batteries only required). Licence needed. Technical queries to Chief Physicist, Royal Victoria Infirmary, Newcastle-upon-Tyne (Tel. 0832 31577). Offers, in writing, to Area Supplies Officer, 11-12 North Terrace, Newcastle-upon-Tyne, NE2 4AD. (7852)

ST. GEORGE'S HOSPITAL MEDICAL PHYSICS TECHNICIAN

Grade IV

is required to help in the development and manufacture of a wide range of clinical and research instruments using both digital and analogue integrated circuit techniques.

The person appointed will join a small group working in the electronics section of the department of Medical Physics.

Minimum qualifications are ONC or equivalent with recognised practical training. Salary £3,162-£4,730 (inclusive of all allowances).

Formal application and request for job description should be made in writing to:

Miss E. Fairclough, Personnel Department, St. George's Hospital, Blackshaw Road, SW17. Tel. 01-872 1255 ext. 4121.

Closing date: 3rd February, 1978.

(7856)

UNIVERSITY OF WARWICK ELECTRONICS TECHNICIAN (Psychology)

A Technician is required for a wide range of electronics development work in the expanding Department of Psychology. There is a particular emphasis on interfacing microprocessors to a variety of measurement and control systems. Applicants are expected to have some experience of logic circuitry. Qualifications to HNC level or equivalent relevant experience are desirable. The post is permanent and pensionable and appointment will be on the Technician Grade 5 scale: £2,889-£3,267 p.a. (under review). Further particulars are available from the Secretary, Department of Psychology (Tel. Coventry 24011 ext. 2165). Letters of application giving full details should be sent to the Academic Registrar, University of Warwick, Coventry CV4 7AL quoting Ref. No. 18/7/77. Closing date for receipt of applications is 30th January, 1978. (7807)

CAPITAL APPTS.

FREE LISTS

101 Design / Development and Test Jobs
Permanent and Contract

To £6,000

7708

637 5551 day; 636 9659 eve.

BRIGHTON POLYTECHNIC LEARNING RESOURCES

VIDEO RECORDING & STUDIO ENGINEER

£3,678-£4,407 p.a. plus up to £17.38 a month supplement

To supervise work in new recording and editing area with colour tele-cine and V.T.R.s, some to broadcast standard, and to assist with operations in two adjoining studios which include a video 80 colour system and a post production area with multi-track sound.

Operational experience of sound and colour video systems, preferably in a broadcasting or educational institution, and an HNC or equivalent educational qualification are desirable.

Application forms and details from the Personnel Officer, Brighton Polytechnic, Moulsecoomb, Brighton BN2 4GJ. Tel: Btm. 693655, Ext. 2536. Closing date: 27th January, 1978.

(7825)

The Polytechnic of North London

(Readvertisement)

ELECTRONICS TECHNICIAN

We are looking for a well qualified electronics technician with a keen interest in video, audio and audio-visual. As a member of the Educational Development Service, the technician would be responsible for:

- * establishing servicing routines and records.
- * establishing technical standards and assisting production staff in video and audio recordings.
- * training and supervising technical staff.
- * developing and building ancillary equipment.

HNC or equivalent qualifications required and minimum of nine years' relevant experience.

Salary Scale: £3671-£4227 (including London Weighting) plus 5% earnings supplement (minimum £2.50 per week, maximum £4 per week).

Application form from Educational Development Service, Polytechnic of North London, Holloway Road, N7 8DB.

(7801)

Could you teach IBM Customer Engineers?

We have a number of opportunities for instructors to train our customer engineers to service and maintain data processing equipment including the latest 370 Systems and Software.

If you're an experienced or potential instructor with a background in software and or electronics, educated to HNC, C & G standard or perhaps you've had similar Service's experience—now's the chance to find out more about these secure, well paid positions based in N.W. London, offering excellent salaries, career development prospects and in depth training.

If you are interested, please write with full career details or phone for an application form to: Anne Dare, IBM United Kingdom Limited, 389 Chiswick High Road, London W4 4AL. Tel: 01-995 1441. Ext. 4786. Quoting ref: ww/93452



(7833)

THE OPEN UNIVERSITY Faculty of Technology RESEARCH TECHNICIAN



(Electronics and Telecommunications)

A Technician is required to join the Electronics Discipline. His or her main duties will be to contribute to the Discipline's research programme in telecommunications, digital processing, instrumentation and control. This will involve the construction and testing of experimental and prototype electronic equipment, the maintenance and updating of documentation and drawings and the general maintenance of the technical facilities in the electronics research laboratory.

The required qualification is ONC in electronics, IS or equivalent, with, preferably, two years' experience of laboratory or prototype development work.

The person appointed will be expected to live within 20 miles of the University. We do offer assistance with removal expenses to make this possible. There is a wide variety of corporation and private housing, and we have an Accommodation Officer to advise and help new appointees.

The appointment is at Technical Grade 3, for which the salary scale is £2455-£2788 per annum (under review with effect from 1.10.77). We offer generous holidays and excellent social and sporting facilities.

Application forms are available, by postcard request please, from The Personnel Manager (112), The Open University, P.O. Box 75, Walton Hall, Milton Keynes, MK7 6AL, or by telephone from Milton Keynes 63868. Closing date for applications: 30.1.78.

(7821)

THE UNIVERSITY OF LEEDS

A vacancy exists in the School of Chemistry Electronics Workshop for an

ELECTRONICS TECHNICIAN (Grade 5)

The successful applicant will develop, construct and maintain a wide variety of electronic equipment. Experience in modern analogue and digital circuit techniques and in the use of test equipment is essential. Minimum qualifications HNC or equivalent plus 7 years' experience. Salary on the scale £3186-£3720 p.a. (under review). Applications giving age, experience, qualifications, state of health and the names and addresses of two referees to: **Mr. G. Spink, School of Chemistry, The University, Leeds LS2 9JT.** (7822)

MAINTENANCE ENGINEER

A young person is required to assist in the maintenance of Recording Studios and Visual Aid Equipment.

Sliding experience, please apply to:
**Nigel Adams
Sound Developments Limited
Spencer Court, 7 Chalcot Road, London NW1** (7828)

ELECTRONICS TECHNICIAN Grade 5 required for an establishment engaged in research and teaching based on a nuclear research reactor. Must be capable of constructing and maintaining a variety of electronic equipment to be found in a nuclear establishment. Applicants should have at least eight years experience and a qualification to ONC level is desirable. A knowledge of digital circuitry would be an advantage. Salary in range £3186-£3720 per annum. Excellent conditions, superannuation scheme. Four weeks annual holiday, plus additional days at Christmas and Easter. Applications, by 14 February 1978 to: The Reactor Supervisor, University of London Reactor Centre, Silwood Park, Sunninghill, Ascot, Berkshire, SL5 7PY. Telephone Ascot 23911, ext 272. (7837)



CAPITAL APPOINTMENTS LTD.

FREE JOBS LIST

for
FIELD SERVICE ENGINEERS
BASIC SALARIES TO
£5,000 + CAR (7187)

30 Windmill Street, London, W1
01-637 5551

If you are looking for a change from Broadcast TV and would like to employ your skills in a different capacity with a rapidly expanding facilities company then we would like to meet and talk to you.

We can offer exciting opportunities to Engineers who can operate and maintain R.C.A., Ampex, Quad Machines and all types of Helical Scan as well as T.B.C.s. and colour Telecines.

Ring us now on 01-580 7161 (7820)

SOUND ENGINEER

The Royal Opera House Covent Garden requires Assistant Sound Engineer. The post will probably suit someone with a studio or broadcasting background who is prepared to work unsociable hours. The work is very varied and requires an engineering bias and some musical knowledge.

Replies to: **Phil Leaver, Royal Opera House, Floral Street, London WC2E 7QA.** (7858)

Marconi Instruments

ELECTRONIC TECHNICIANS

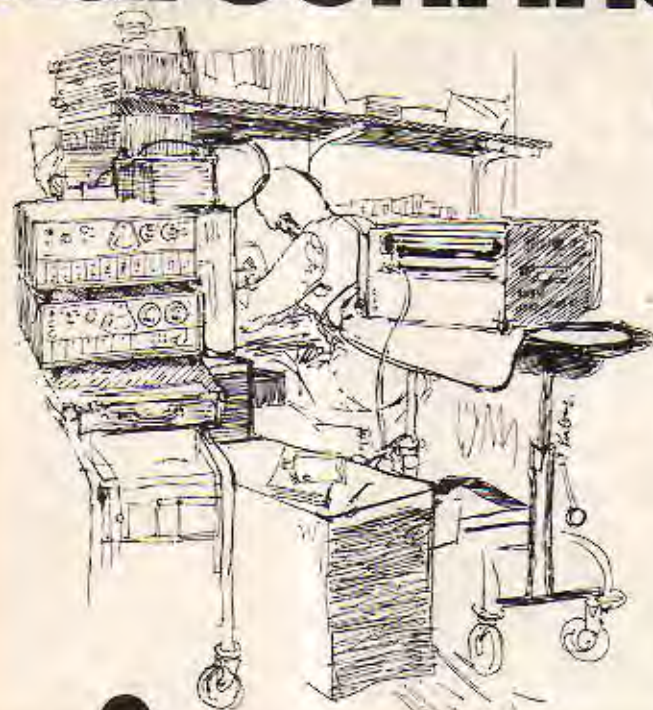

Opportunities for the experienced and sometimes inexperienced in St. Albans and Luton.

Work situations range from fault finding on PCB's and components, to batch product testing of equipment that utilise very advanced techniques including microprocessors and the repair/calibration of all manner and types of test instruments.

Attractive salaries and, where appropriate, relocation are offered for the right candidates. Further information may be obtained in confidence from John Prodger

Marconi Instruments Limited,

Longacres, St. Albans, Herts. tel: St. Albans, 59292



A GEC-MARCONI ELECTRONICS COMPANY

(7848)

mi

WIRELESS TECHNICIANS

There are a limited number of vacancies at the following Home Office Depots: Andover and Hannington Hants, Bridgend Mid Glamorgan, Guildford Surrey, Hinchbrook Hunts, Lewes East Sussex and Romsley West Midlands for Wireless Technicians to assist with the installation and maintenance of VHF and UHF systems.

Applicants must be able to drive a car and be in possession of a current UK driving licence.

Salary

is £2,010 (at 17), £2,450 (at 21) and £2,905 (at 25) rising to £3,385, plus a 1976 pay supplement of £313.20 a year and a 1977 pay supplement of 5% of total earnings, subject to a minimum of £101.79 a year and a maximum of £208.80 a year.

A Secure Future

with a non-contributory pension scheme, good prospects of promotion and a generous leave allowance. There are opportunities for day release to gain higher qualifications.

Qualifications

Candidates, male or female, must hold a City and Guilds Intermediate Telecommunications Certificate or equivalent and have practical experience of maintenance and construction of VHF and UHF wireless equipment and a working knowledge of workshop techniques.

Applications from Registered Disabled Persons will be considered.

Interested?

Then write or telephone for further details and an application form: to Mr C B Constable, Directorate of Telecommunications, Horsafery House, Dean Ryle Street, London SW1 2AW. Telephone: 01-211 6420.

7803



Home Office

RADIO TECHNICIANS

The Home Office has vacancies for Radio Technicians to carry out maintenance, modification and construction of specialised equipment including mechanical construction. Applicants must have a good understanding of radio fundamentals and be familiar with commonly used radio components and test equipment. The vacancies will be located at Stanmore, Middlesex, Central London (near Waterloo Station) and Baldock, Herts.

Qualifications and Experience

Applicants must possess either a City and Guilds Intermediate Telecommunications Technicians Certificate, a relevant ONC or equivalent qualification plus 1 year's practical workshop experience. Applications from Registered Disabled Persons will be considered.

Salary

is £2,010 a year at 17, £2,450 at 25 or over on entry, rising to a maximum of £3,385, plus a 1976 pay supplement of £313.20 and a 1977 pay supplement of 5% of total earnings, subject to a minimum of £101.79 a year and a maximum of £208.80 a year. A London Weighting Allowance of £465 a year is payable in Central London and £275 a year at Stanmore.

A Secure Future

with a non-contributory pension scheme, prospects of promotion, generous leave allowance, further education facilities and a 5-day week of 41 hours in London and 42 elsewhere.

Interested?

Then write or telephone for application forms (for return by 8th February 1978) to: Mr J J Willis, Directorate of Radio Technology, Room 514, Waterloo Bridge House, Waterloo Road, London SE1 8UA. Telephone: 01-275 3006.

(7799)



Home Office

Project Engineers Electronic Control Systems

Johnson Matthey & Co. Ltd., world leaders in refining and fabricating precious metals have vacancies for experienced Electronic Engineers to join our small, specialist team at Wembley. With an HNC/HND or degree level qualification, you'll be involved in the design, production and installation of electronic control systems to the individual requirements of our manufacturing centres.

Systems Engineer

Drawing on your management abilities, you'll detail the systems and equipment design and organise their manufacture and installation. There will be some travel involved and a clean driving licence is essential.

Electronic Engineer

You'll need to be able to think creatively for you will design the analogue and digital circuits to their pre-production stage from stated functional requirements and assist in the design of production equipment.

We are offering competitive salaries, according to age and experience, for a 37.5 hour week. In addition, we offer free lunches, 4 weeks' annual holiday and a contributory pension scheme.

To apply, please write or telephone I.J. Middleton-Stewart, Staff Officer.

(7847)



JOHNSON MATTHEY
100 HIGH STREET • SOUTHGATE
LONDON N14 6ET • 01-882 6111

Electronics Engineer

We require an Electronics Engineer at our Research Laboratories at Alderley Park to strengthen a team involved in the design and development of Biological and Research instruments.

Ideally candidates, male or female, should be qualified to HNC/HND or equivalent standard and have had four or more years experience of electronic design. A good knowledge of analogue and digital circuit design using the latest component technology is essential.

Age: 25 years plus.

Please apply in writing to:



Mr M. J. Higgins
Personnel Department
ICI Pharmaceuticals Division
Mereside Alderley Park
Macclesfield Cheshire

(7816)

Radio Engineers

Opportunities exist for several additional experienced radio engineers to join this leading firm of Consulting Engineers.

Vacancies exist both in our Brighton Offices and for engineers to serve on contract in the Middle East.

Chartered Engineers who have experience in several of the following fields are invited to apply; h.f. transmitters and receivers, sound broadcasting, m.f. and h.f. antennas, m.f. and h.f. propagation.

Salaries for engineers based in Brighton will be in the range £5,500 to £7,500 p.a. with the usual fringe benefits including assistance with removals.

Salaries for engineers contracted abroad will be about double the above range and these salaries are normally payable tax-free usually with free traveling and local accommodation.

Degree Engineers with extensive experience who are not Chartered may also be considered.

Please write or telephone:

G. E. Tedder, Group Personnel Manager,
PCR Service Company,
Paston House,
165/167 Preston Road,
Brighton, Sussex.
(0273) 507131

(7811)

The Polytechnic of North London

Department of Electronic and Communications Engineering

TECHNICIAN GRADE IV or V

Applications are invited for the appointment of a Grade IV or V Technician in the Department of Electronic Communications Engineering.

This interesting post involves the operation and maintenance of high grade test equipment, together with the general responsibility for students' day-to-day requirements with experiments and projects in the laboratory.

Important participation in research work in liaison with academic staff for the right applicant, leading to promotion prospects.

Educational level for Grade IV ONC/OND and Grade V HNC/HND in appropriate subjects.

Experience: Grade IV at least 7 years (including training period).
Grade V at least 8 years (including training period).

Salary Scales: (inclusive of London Weighting).
Grade V £3216-£3672 plus 5% earnings supplement
Grade IV £3024-£3450 (Maximum £4 per week)

Application forms obtainable from the Establishment Officer, Polytechnic of North London, Holloway Road N7 8DB. Further details from the Departmental Laboratory Superintendent Mr. S. Elliott 607 2789 extn. 2176.
(7853)

BRUSSELS

The Technical Centre of the European Broadcasting Union is seeking an

EDITORIAL ASSISTANT

for duties entailing the processing of English editions of the E.B.U.'s technical periodicals from source material to publication.

This post would suit an Engineer or Technician of English mother-tongue, with training and experience in telecommunications - preferably broadcasting - and the ability to produce documents in faultless English from English and French material, as well as precise translations of technical reports and correspondence. A higher - than - average proficiency in the French language is evidently essential.

The salary will be in the vicinity of 550,000 Belgian francs per annum, depending upon age and experience, with good prospects of advancement.

Candidates should write giving details of education and experience to:

The Director, Technical Centre of the European Broadcasting Union
Avenue Albert, Lancaster 32, B-1180 Bruxelles (Belgium)

(7800)

**DESIGN
ENGINEER****BBC Recording**

BBC requires an engineer with special responsibility for audio recording in its Design Department in central London. Much of the work is appraising or modifying commercial audio recording equipment and advising those responsible for audio operations and installations. There is also a substantial amount of original design, both mechanical and electronic, for auxiliary equipments and specialised recording systems.

Preference will be given to applicants having an appropriate University degree or professional qualification. The successful candidate is likely to have a substantial knowledge of the theory of magnetic recording, a wide experience of types of recorders, media and formats, and be skilled in operational alignment and laboratory measurement of audio recording systems. He/she will be experienced in the design of electronic circuits and mechanical devices, and familiar with digital techniques, logic and process control, and the use of time code signals for editing.

The post involves liaison with a wide range of engineers and managers in Radio, Television and External Broadcasting, and in industry. The post-holder must be able to establish effective communication with them and provide expert advice including technical reports and the recommendation of alternatives.

Salary according to experience in the range £5050 - £5430 rising to £6000, opportunities for promotion. Pensionable post.

Write for application form to **The Engineering Recruitment Officer, BBC, Broadcasting House, London, W1A 1AA**, quoting reference 77.E.4094/WW and enclosing a self addressed envelope at least 9" x 4"

Closing date for completed application forms is 14 days after publication.

BBC

1459

AMPEX

Ampex International recherche un ingénieur bilingue expérimenté pour l'élaboration de systèmes de télévision destinés à la France, la Belgique et aux pays d'Afrique francophone.

Sa fonction consistera en l'élaboration d'offres techniques en français, au sein d'une équipe depuis longtemps implantée sur les marchés internationaux. La connaissance des deux langues est indispensable.

Please reply, in French or English, to:

D. J. Lambert
AMPEX ELECTRONICS LTD.
Acre Road
Reading RG2 0QR

LINK**CHECK OUT NEXT
GENERATION'S
COLOUR TV CAMERAS**

Just about to go into production is our multi-mode colour camera which supplements our well known type 110 studio/OB version, now selling in increasing quantities.

Test Engineers are needed who can cope with high technology designs covering the whole spectrum of studio broadcast equipment. A background of circuit theory up to HNC/D/degree standard is essential, although knowledge is more important than a piece of paper.

You must have spent at least a year or two in industry and the experience you have will dictate the complexity of equipment you can work on initially. Domestic TV experience alone is, regrettably, insufficient.

You would be joining a young team in a successful operation, offering salary and benefits normally associated with a much larger company, plus financial help in relocation, where necessary.

Our modern factory in Andover is well placed for a good selection of housing and there is easy access to London and many major towns in the south and Midlands.

Please phone Jean Smith at 0264-61345 for an application form or write to Mic Comber at the address below, giving enough detail of qualifications, experience and salary progression, to make a form unnecessary.

LINK
ELECTRONICS

North Way, Andover
Hampshire, England

Telephone:
Andover (0264) 61345

SITUATIONS VACANT

RADIO TECHNICIANS

Government Communications Headquarters has vacancies for Radio Technicians. Applicants should be 19 or over.

Standards required call for a sound knowledge of the principles of electricity and radio, together with 2 years experience of using and maintaining radio and electronic test gear

Duties cover highly skilled Telecommunications/electronic work, including the construction, installation, maintenance and testing of radio and radar telecommunications equipment and advanced computer and analytic machinery

Qualifications: Candidates must hold either the City and Guilds Telecommunications Part 1 (Intermediate) Certificate or equivalent HM Forces qualification.

Salary scale from £2,230 at 19 to £2,905 at 25 (highest pay on entry), rising to £3,385 with opportunity for advancement to higher grades up to £3,780 with a few posts carrying still higher salaries. Pay supplements total between £443 and £522 per annum.

Annual Leave allowance is 4 weeks rising to 6 weeks after 27 years' service.

Opportunities for service overseas.

Candidates must be UK residents.

Further particulars and Application forms available from:

Recruitment Officer
Government Communications Headquarters
Oakley, Priors Road
CHELTENHAM, Glos GL52 5AJ
Tel. Cheltenham 21491 Ext. 2270
(STD 0242-21401)

(7741)

BROADCAST V.T.R. ENGINEERS

Due to expansion vacancies exist for experienced engineers with suitable qualifications. Depending on the successful applicants' experience, the posts will be substantive engineers or senior engineer (ACTT/ITCA salary grades). Duties will involve operation + Maintenance of TR70c + AVR 2 machines together with a (CDL timecode) editing suite, so knowledge of these would be an advantage.

Please write: Graham Saych, Ewart & Co. (Studio) Ltd., Wandsworth Plain SW18 1ET.

(7839)

ARTICLES FOR SALE

MORSE CODE RECEIVING AND SENDING

Receiving:
CASSETTE A For Amateur Radio examination preparation. Speed slowly increasing from 1-12 w.p.m.
CASSETTE B For Professional examination preparation. Computer produced morse from 12-24 w.p.m. Including international procedure signs and symbols and their incorporation into messages.

Sending:
Morse Key and Buzzer Unit for sending practice and own Tape preparation. Phone output.
Prices: each cassette, including booklets, £4.50
Morse key and buzzer unit, £4.50

Prices include VAT, postage, etc. Overseas Airmail £1 extra

M. H. ELECTRONICS
12 LONGSHORE WAY, MILTON, PORTSMOUTH PO4 8LS

COMMUNAL TELEVISION EQUIPMENT

Offers are invited for the following equipment which has been made redundant by the re-engineering of the Council's Communal Television System.
VHF Distribution Equipment consisting of a complete head end with AGC Amplifiers
12 Repeater Amplifiers of tele type 6301
Communal Television Mast and Aerials.

All enquiries should be addressed to:
H. Davies, A.R.I.C.S., Valuer to the Council, Borough of Milton Keynes, Sherwood House, Sherwood Drive, Bletchley, Milton Keynes MK3 6DE.
Tel: Milton Keynes (0908) 71171 Ext. 427.

(7808)

DEVELOPMENT ASSISTANT. Rank Video Centre is a fast expanding broadcast television facilities house, located in the centre of London, operating state-of-the-art technology. A vacancy has occurred within the Research and Development Department for an enthusiastic Engineer having a good basic knowledge of the PAL colour TV system and who is conversant with the latest analogue and digital techniques. The successful applicant will be responsible to the R & D Supervisor for manufacture and testing of prototype equipment for final installation and operation within the various facilities departments of the company. This post offers a unique opportunity for an Engineer, ideally aged 22-28, having an aptitude for design and construction work, to join a small, active team providing specialist back-up to a busy commercially oriented company. Starting salary will be £4,000 plus p.a. with automatic progression over 5 years. Application, in the first instance, should be in writing to:—
Garry A. Duguid, C.Eng., MIERE, Chief Engineer, Rank Video Centre, Film House, 142 Wardour Street, London, W1V 4BU. (7850)

THE UNIVERSITY OF LEEDS. Electronics Technician Grade IIIE required. Will be responsible, under the head of the Department and the Departmental Electronics Engineer, for the construction, modification and maintenance of electronic equipment associated with research and teaching of biological studies. Must be capable of working from precise instructions, circuit diagrams, sketches and manuals. Applicants should hold ONC or equivalent qualifications in relevant subjects. Salary on the scale £2,688-£3,060 according to qualifications and experience. Applications stating age, qualifications and full experience together with the names and addresses of 2 referees should be addressed to:
Mr. E. French, Departmental Superintendent, Department of Physiology, Medical Multipurpose Building, Mount Preston Street, Leeds LS2 9NQ. (7854)

ARTICLES FOR SALE



NEOPRENE SHEET, RUBBER AND PLASTIC EDGING, WINDOW RUBBERS. Write or Phone List MELFLEX, 934 Wimborne Road, Bournemouth Tel: 0202 527934 (7844)

JERMYN INVERTER CHARGES 24 volt battery from mains supply and when this supply fails automatically provides 300 watt 240 volt 50 cycle square wave, £60. Valradio d24/200S transverter provides 300 watt 240 volt 50 cycle sine wave from 24 volt battery £110. Both units in excellent condition and in working order buyer to collect Kingston upon Thames area. Telephone 01-942 1230. (7819)

VALVES RADIO — T.V. Industrial-Transmitting. We dispatch valves to all parts of the world by return of post, air or sea mail, 2,700 types in stock, 1930 to 1976. Obsolete types a speciality. List 20p. Quotation S.A.E. Open to callers Monday to Saturday 9.30 to 5.00. Closed Wednesday 1.00. We wish to purchase all types of new and boxed valves. Cox Radio (Sussex) Ltd., Dept WW, The Parade, East Wittering, Sussex PO20 5BN, Westing. Wittering 2023 (STD Code 024388). (5392)

VHF/UHF MONITOR RECEIVERS, air, marine and business bands, all crystal controlled, from £50. Send 15p PO, not stamps. Radio Communications Ltd, St Sampsons, Guernsey, G.I. (7738)

WE INVITE ENQUIRIES from anywhere in the world. We have in stock several million carbon resistors ½, 1, 2, and 1 watt, ½ million wire wound resistors 5 and 10 watt — 1 million capacitors — 1 million electrolytic condensers — 3 million transistors and diodes, thousands of potentiometers, and hosts of other components. Write, phone or call at our warehouse. — Broadfields and Mayco Disposals Ltd., 21 Lodge Lane, North Finchley, London, N.12. 01-445 0748, 445 2713. (5907)

300,000 MULLARD C 250 & C 251 for sale, valves from 01UF to above 1 UF 250/400 V/W price per mixed pack, 100/£150, 500/£7.00 P&P (export 50p). Electronic Mallordealtd., Ramsbottom, Bury, Lanes. (7512)

THE FABULOUS D2 MICROPROCESSOR EVALUATION KIT FROM MOTOROLA

Featuring 24 key keyboard 7-segment display Cassette interface 8rom & Ram Expandable Interface Capability. Full Documentation 5 Volt power supply required 100 year's FREE membership of the Amateur Computer Club with every purchase! £176 + £1.50 P&P + 8% VAT.

ENAMELLED COPPER WIRE

SWG	1 lb	8 oz	4 oz	2 oz
14-19	2.80	1.40	.66	.55
20-29	2.80	1.60	.95	.65
30-34	3.00	1.70	.95	.70
35-40	3.35	1.90	1.10	.79
40-43	4.50	2.50	1.80	1.25
44-46	5.00	3.00	2.10	1.65
47	8.00	5.00	3.00	1.76
48	15.00	9.00	6.00	3.50

Tinned Copper, Even Gauges 14-30 £3 per lb. Multicore 80/10 Solder 185SWG £3.24 per lb. Prices include P&P and VAT. SAE brings list of copper and resistance wires.

THE SCIENTIFIC WIRE COMPANY
PO Box 30 London E.4 (7771)

THE UNIVERSITY OF LEEDS. A vacancy exists in the Department of Electrical and Electronic Engineering for an Electronic Technician (Grade 5) to work in the Electronics Workshop. This workshop undertakes the development and construction of prototype electronic equipment used in teaching and research together with the modification testing and maintenance of an extensive range of electronic equipment used in the teaching and research laboratories. The minimum qualifications required are ONC, OND or City and Guilds certificates in Electronic Engineering together with at least 7 years relevant experience. Salary on the scale £3,186-£3,720 a year. Applications should be sent to Mr. C. S. Petch, Department of Electrical and Electronic Engineering, The University Leeds LS2 9JT. (7826)

Quartz Crystal Units
ACCURATE RELIABLE
Private enquiries, send 1.3p in stamps for brochure
THE QUARTZ CRYSTAL CO. LTD.
Q.C.C. WORKS, WELLINGTON CRISSETT
NEW MALDEN, SURREY. 01-942 0354 & 2985

ARTICLES FOR SALE



AUDAX

HD129D25	7.50
HD13DJ4	8.95
HD13D34H	12.50
HD13D37	12.25
HD10D25AV	7.50
HD11P25BC	6.95
HD17B37	17.50
HD21B37	18.50
HD20B2534	10.95
HD20B26H4	14.65
HIF13E 5"	5.25
HIF21E 8"	6.95

CELESTION

HF1300 II	7.50
HF2000	9.75

COLES

4001	5.90
3000	6.25

EMI

350 4 OHM	7.95
12" 14A/1200	14.95
14" x 9" 14A770	12.50
13" x 8" BASS	8.95

DALESFORD

D20/105 4" MID	9.95
D30/110 5" BASS	9.95
D50/153 6 1/2" BASS	10.95
D50/200 8" BASS	10.95
D70/200 8" BASS	21.75
D100/200 8" BASS	23.50
D70/250 10" BASS	24.95
D100/310 12" BASS	30.95

FANE

13" x 8" 138/101	5.95
------------------	------

JORDAN WATTS MODULE

JORDAN WATTS HI FREQUENCY KIT

	17.95
	7.85

KEF

T27	8.50
T15	10.75
B110	10.95
B200	11.95
B139	24.95
DN12	7.25
DN13 SP1106	4.95
DN13 SP1017	4.95
DN22 (104AB)	36.00

MOTOROLA

PIEZO HORN	8.50
------------	------

TANNOY

HPD285A	83.00
HPD315A1	93.00
HPD385A	110.00

Everything in stock for the speaker constructor! BAF, long fibre wool, foam, felt panels, crossovers and components. Large selection of grille fabrics. Send 15p stamps for samples.

Send 15p stamps for free 38-page catalogue "choosing a speaker".



Swan Works, Bank Square, Wilmslow, Cheshire.

Lightning service on telephoned credit card orders!

Tel: Wilmslow 29599

SEMICONDUCTOR CIRCUIT DESIGN

VOL. V
by Texas
Price £9

ACTIVE FILTER COOK BOOK by D. Lancaster. £10.85.

I.C. TIMER COOK BOOK by W. G. Jung. Price £7.50

HANDBOOK OF LINEAR INTEGRATED ELECTRONICS FOR RESEARCH by T. Hamilton. Price £15.

BUILT YOUR OWN WORKING ROBOT by D. L. Heiserman. Price £3.70

MICROPROCESSORS & SMALL DIGITAL COMPUTER SYSTEMS by G. A. Korn. Price £18.90

LOGIC DESIGN PROJECTS USING STANDARD I.C.s by J. S. Wakerley. £5.00

TOWER'S INTERNATIONAL TRANSISTOR SELECTOR by T. D. Towers 1977. Price £5.00

HYBRID MICROELECTRONICS by T. D. Towers. £8.00

* Prices include postage *

THE MODERN BOOK CO.
SPECIALISTS IN SCIENTIFIC & TECHNICAL BOOKS
19-21 PRAED STREET
LONDON W2 1NP
Phone 723 4185
Closed Sat. 1 p.m.

ENAMELLED COPPER WIRE

s.w.g.	1/2 reel	3/4 reel
10 to 19	£2.95	£1.80
20 to 29	£3.15	£1.80
30 to 34	£3.45	£1.80
35 to 40	£3.85	£2.10

All the above prices are inclusive of postage and packing in UK.

COPPER SUPPLIES
102 Parrwood Road, Withington
Manchester 20
Telephone 061-445 8753

ENAMELLED COPPER WIRE

Swg	1 lb.	4oz.	2oz.
14-19	2.40	.69	.50
20-29	2.45	.82	.59
30-34	2.60	.89	.64
35-40	2.85	1.04	.75

inclusive of p&p and VAT
SAE brings Catalogue of copper and resistance wires in all coverings

THE SCIENTIFIC WIRE COMPANY
PO Box 30, London E4 9BW (7347)

ELECTRONIC TIMESAVER LEARNING AID. Unique, practical, hi-speed learning. Ideal beginners, students, clubs, schools, colleges. Normal price £9.00. Sliding introductory offer £4.75 until February 28th. Dept. WW, TECHNOCENTRE, PO Box 33, Acklam, Middlesbrough. (7802)

LAB CLEARANCE: Signal Generators; Bridges; Waveform transistor analysers; calibrators; standards; millivoltmeters; dynamometers; KV meters; oscilloscopes; recorders; Thermal sweep, low distortion, true RMS, audio, FR, deviation. Tel: 040-378236. (7789)

RUB-ON ETCH RESISTANT SYMBOLS for 1 off Printed Circuits. Large range of lines, pads, letters, etc. available 27p/sheet. SAE catalogue and sample. PKG ELECTRONICS, Oak Lodge, Tanstey, Derbyshire. (7809)

COLOUR, UHF AND TV SPARES. TELETEXT 77 IN COLOUR. MANOR SUPPLIES "EASY TO ASSEMBLE" KIT, including TEXAS Decoder. Aerial input, completely external unit, no further connections to set. Full facilities, mixed TV programme and Teletext, Newsflash. Update, and many special features not found in other units. Demonstration model in operation at 172 write for further information.

NEW COMBINED COLOUR BAR GENERATOR PLUS CROSS HATCH KIT (MK4) UHF Aerial input type. Eight vertical colour bars plus R-Y, B-Y. Luminance combinations, Grey scale etc. Push button controls. Battery operated. £35. Case £2.40. Battery Holders 75p. p/p £1.

CROSS HATCH KIT. UHF Aerial input type, also gives peak white and black levels. Battery operated. £11. p/p 40p. Add-on Grey Scale kit £2.90. p/p 35p. Add-on Colour Bar Kit (MK 3) £25. Cases £1.40. p/p 95p. Cross Hatch Unit, complete and tested in De Luxe case £18.00. p/p £1.

Wireless World TV Tuner and FM Tuner Projects by D. C. Read. Kits of parts available. ORT test and reactivator kit for colour and mono £18.80. p/p £1.20. UHF Signal Strength Meter kit £18. p/p 80p. 625 TV IF Unit for Hi-Fi amps or tape recording £6.30 p/p 70p. Decca Colour TV Thyristor Power Supply Unit, incl. H.T., L.T., etc. incl. circuits £3.80 p/p £120 Bush CVT 25 Power Supply Unit incl H.T., L.T., etc. £3.20 p/p £1.20. Bush CVT 25 Convergence Panel plus yoke, blue lateral £3.60 p/p 90p. Philips Single Standard Convergence Units complete, incl. 16 controls £3.75 p/p 85p. Colour Scan Coils, Mullard or Plessey, £6 p/p 80p. Mullard AT 1023/05 Converg. Yoke £2.50 p/p 75p. Mullard or Plessey Blue Laterals 75p p/p 35p. BRC 3000 type Scan Coils £2 p/p 90p. Bush CVT 25 Scan Coils £2.50 p/p 90p. Delay Lines: DL20 £3.50, DL40 £1.50. DL1E, DL1 85p p/p 45p. Lum. delay lines 50p p/p 40p. G8 Tripler £6. BRC 300 Tripler £6.60 p/p 75p. Others available, Philips G8 Decoder part-complete, £2.50 p/p 75p. GEC 2040 Ex-Rental Panels, Decoder £3.00. Time Base £5.00. p/p 90p. VARICAP TUNERS. UHF: ELC 1042 £4.50, ELC 1043/05 £5.50, VHF: ELC 1042 £4.80, Philips VHF £3.80. Salvaged UHF & VHF Varicaps £1.50 p/p 35p. SPECIAL OFFERS: 6 Psn Varicap Control Unit £1. 7 Psn De Luxe Control Unit £2.50. p/p 35p. UHF Transd. Tuners incl. slow motion drive £3.80. 4 Psn and 6 Psn. Push button transd. £4.20 p/p 95p. Helical Pots 100K, 4 for £1.20 p/p 30p. Thorn 850 Dual Std. Time Base panels 50p. Philips 625 IF panel incl. cct. 50p p/p 70p. VHF Turret Tuners AT 7850 for KB Featherlight, Philips 19TG170, GEC 2010 etc. £2.50. Fireball Tuners, Ferguson, HMV, Marconi 80p. p/p all tuners. 80p. Mullard Mono Scan Coils for Philips, Stella, Pye, Ekco, Ferranti, Invicta £2.00 p/p 85p. Large selection LOPTS, FOPTS available for most popular makes. MANOR SUPPLIES, 172 WEST END LANE, LONDON, N.W.6. Shop Premises. Callers welcome. Thousands of additional items available not normally advertised. (Nos. 28, 159 Buses or West Hampstead-Bakerloo Line and British Rail). Mail Order: 64 Golders Manor Drive, London, N.W.11. Tel: 01-794 8751. V.A.T. Please ADD 12% TO ALL PRICES (EXCEPT WHERE MARKED* V.A.T. 8%) (60)

BRUEL & KJAER low noise measuring amplifier type 2607. Precision sound / vibration measurement, 10uV to 300V. List £2000 plus sell for £1450.. 0527 892378. (7857)

FOR SALE. Several hundred copies of the Wireless World from 1933-1939. P. E. Brooks, 7 Belgard Road, Poole, Dorset. (7840)

ECIO transistored communications receiver battery/mains, used twice. Offers still in original packing. Phone evenings 769 0212. (7839)

PERSONAL
SPEAK TO THE WORLD without Licence! Worldwide Tapetalk, 35 The Gardens, Harrow, Britain's largest Tape-X-Change. (7806)

EXCLUSIVE OFFER

HIGHEST QUALITY 19" RACK MOUNTING CABINETS
Over 80 types available from 12" to 90" high. Also racks, tripods & consoles. Below are only a few types. Please send for full list.

Type	Height	Weight	Price
RA1	10"	13	£10.00
RA2	12"	21	£20.00
RA3	14"	25	£28.00
RA4	16"	26	£50.00
RA5	18"	26	£20.00
RA6	20"	21	£20.00
RA7	22"	24	£70.00
RA8	24"	24	£30.00

Rack cabinets for RA-17/117

AUDIO AND INSTRUMENTATION TAPE RECORDER-REPRODUCERS

- Fluxes: 100X Digital Units, 1 Track 1/2"
- Plessey M500 Digital Unit, 1 Track 1/2"
- Amplex FR-100, 6 speeds, stereo 1/2"
- Amplex 10600, 4 speeds, 1 Track 1/2"
- D.R.I. RM1, 4 speeds, 4 Tracks 1/2"
- EMI 1000 2 speeds, 1 Track 1/2"
- MIRTR1, 1 speed, 1 Track 1/2"
- MIRTR01G, 2 speeds, 2 Tracks 1/2"
- Mitsum CMP-100, 6 speeds, 2 Tracks 1/2", 1"
- Leevers Tech DA 29, 2 speeds, 2 Tracks 1/2"
- Leevers Tech Cones 2 Track 1/2", 2 speeds

Prices of above £70 to £500

Also Transact Decks only available

We have a large quantity of "bits and pieces" low cost items. Please send your requirements, we can probably help - all enquiries answered.

All our aerial equipment is professional MOD quality

- Wireless World Vol 1, No 1 (Induct)
- Racal MA-75 Universal Drive Units
- Racal RA-100 Receivers (new)
- Racal RA-100 Receivers (new)
- Form Coupled Voice Frequency Teletext
- Racal & Schwarz ISM Tunable VHF Receivers 30-180 MHz
- Racal & Schwarz HPH (Well Strength HF Loop Aerial)
- Nida, 200 Prog meters 200 SW MHz
- Cosser C145 Electronic Volt meters
- Racal 2400 Electronic Multimeters
- Sligh & Chester Multi-purpose Trainers with Jacks 12" x 17"
- Racal RA-17L Receivers
- Racal & Schwarz Fibreglass HA Diversity Dipole
- SE4/2B CRT
- SE5/2A CRTs
- SE4/2 (DMN 811) CRTs
- M.I. Documents C.C.T. Ducts
- Advance 3KVA AC Transformers
- Counger HF Log Amplifier Aerial
- Metal V.D.U. Tables 30" x 30" x 30"
- Devian Logic Testers
- General Radio Straybars

MANUALS
We have a quantity of Technical Manuals of Electronic Equipment, inc. photostats, 1940 to 1960, British and American. No bids. Enquiries invited.

- Data Efficiency Response 2000
- Beving Low Impedance Interference Filters
- Armes 201 Sig. Gen. 20 KCS 30 MCS
- Oscilloscopes Gen. purpose 2"
- Armes 702 Sig. Gen. 20 300KCS
- R-216 Power Supply Units
- Oscilloscope Trailing Term
- M.I. Video Diode Units 4-12"
- Audiphon VHF Receivers 20-120MHz
- Solomon CD 324 Oscilloscopes
- AWI VT Voltmeters CT-471A
- Racal MA157B pre-selector
- Collins 500 watt 2-18 mcs. Transmitters
- Collins KW16 SSB 500W Transmitters
- Collins KW16 200 m/w AM Transmitters
- SEC R3-2-25 mcs. Harmonic Diversity
- Rack Mounting Oscilloscope Tables
- Gaumont Kales 354 Fluter Motors
- Hewlett Packard 6158 Sig. Gen. 3.8-7.2 GHz
- Kenn 600 mcs. lattice 12" video
- 300 Lattice Masts, 14' masts
- 120 Lattice Mast sections, 20' masts
- 1200 Lattice Masts, 15' masts
- 75-500 Sec. Towers, self supporting
- Heavy Aerial Rotators
- 750 Aluminium Lattice Masts, 25' masts
- Racal & Schwarz SSB sig. gen. 7.6-2.4 GHz
- Racal MA 175 1.5 B. Modulators (new)
- 45 feet Cones 4 Cones 30 ohms
- Balun Professional Exterior 100' 16 ohms
- Video 8 Track Tape Punches
- Quality Weather Vane Contacts (new)
- Racal MA 175 1.5 B. Modulators (new)
- Insulate Cabinet Shelf Sliders
- Tally 8 Track Tape Reader 80 cps
- Daily 8 Track Tape Reader Track Spooling

We have a quantity of Power Transformers 250 watts to 15KVA at voltages up to 48KV. Best quality at low prices. Lists available.

- Racal RA-85 SSB Adaptors, new
- Racal RA 157 L.W. Converters, new
- Racal RA 158 L.S.B. Transceiver Converter (new)

We have a large assortment of industrial and professional Cathode Ray Tubes available. List on request.

PLEASE ADD CARRIAGE AND V.A.T.

P. HARRIS ORGANFORD DORSET BHT6 6BR BOURNEMOUTH (0202) 765051

ARTICLES WANTED

WANTED IN
LARGE
QUANTITIES

Electronic components, resistors, capacitors, potentiometers, chassis loudspeakers, semi-conductors, diodes, TV tubes, especially colours, etc., etc., etc. First or second grades. Finished or incomplete products, record players, amplifiers, radios, tuners, tape recorders, enclosures etc., etc. etc.

We will buy complete factories and pay cash.

TEL. 01-491 4636
E.C.E. AVON HOUSE
360/366 OXFORD STREET
LONDON, W.4 (7827)

WE PURCHASE ALL FORMS
OF ELECTRONIC
EQUIPMENT AND
COMPONENTS, ETC.

SPOT CASH
CHILTHEAD LTD.
7, 9, 11 Arthur Road
Reading, Berks.
Tel. (0734) 582 605

A.R. Sinclair

Electronic Stockholders
Stevenage 812193

We purchase all types of
Mechanical and Electronic
Equipment and Surplus stocks.

(7807)

WANTED, all types of communications receivers and test equipment. Details to R. T. & I. Electronics Ltd., Ashville Old Hall, Ashville Rd., London, E.11. Ley 4986. (63)

COSSOR CDU 120. Wanted, plug in or whole scope. Any condition. Ring G.A.S. on 01-853 1818. (7805)

WILL BUY ANYTHING, any quantity if price is right. Ring Stan Willetts, West Bromwich, 021-553 0186. (7813)

ARTICLES FOR SALE

60KHZ MSF Rugby Receiver. BCD TIME OF DAY OUTPUT. High performance, phase locked loop radio receiver, 5V operation with 1 second LED indication. Kit complete with tuned ferrite rod aerial £14.08 (including postage and VAT). Assembled circuit and case, up version also available. Send for details. Toolex, Sherborne (4359), Dorset. (21)

SOLARTRON CT436 oscilloscope mains transformer wanted. Phone 0723 870884. (7841)

TEKTRONIX 545B C/W CA plug in, immaculate, £350. 561A mainframe £120; 11B2A time base £150. CA dual trace £50; S54 pulse generator £110; sweep frequency converter £60; constant amplitude signal generator £65. Hewlett Packard 175A C/W 1755A dual trace 50 MHz and 1781A delaying time base £200. 693D sweep oscillator A-5 GHz. £200. Terroid 707D sweep oscillator 10-1-MHz. £70. Wayne Kerr B521 LCR Bridge £80; B221 LCR Bridge 0.1X £110. Sultzer frequency standard 5A. 100 KHZ 1MHz, 5MHz. O/P. 5x10-10 stability £70. VLF receiver for precision frequency comparison £210. Branson, 111 Park Road, Peterborough. (7804)

OFFERS INVITED for PDP9 16K computer with 2 cpcwriters, 2 tape transports, Dec PDP9L 4K memory. Box Number WW 7816

T.V. TUBE REBUILDING PLANT. Western-Whybrow Engineering can supply all items of plant for quality rebuilding of Colour Tubes. Complete installation, training, and all associated supplies. Western-Whybrow Engineering, WECO Works, Fraa Sands Cross, Penzance. Tel: (073 676) 2265. (7781)

WANTED

for immediate cash
ALL MAKES OF
OLD RADIOS AND
GRAMOPHONES
PRIOR TO 1940

Offers with details and photos (returned) to:
Wallfass, P.O. Box 1244
D-4050 Moenchengladbach
W. Germany (7357)

★ MINICOMPUTERS
★ PERIPHERALS
★ INSTRUMENTATION

For latest, best CASH offer, phone

COMPUTER APPRECIATION
Godstone (088 384) 3221 (7817)

MINICOMPUTERS
PERIPHERALS
INSTRUMENTATION

For fastest, better CASH offer
Phone.

CHILTHEAD LTD.
Reading (0734) 586419

TURN YOUR SUPPLUS Capacitors, transistors, etc., into cash. Contact COLES-HARDING & Co., 103 South Brink, Wisbech, Cambs. 0445-4155. Immediate settlement. We also welcome the opportunity to quote for complete factory clearance. (7439)

STORAGE SPACE is expensive, why store redundant and obsolete equipment? For fast and efficient clearance of all test gear, power supplies, PC boards, components, etc. regardless of condition or quantity call 01-771 9413. (7414)

B.D. ELECTRONICS offer prompt settlement for surplus electronic components, i.v./audio spares are of particular interest. Contact Miss Hughes, 9 Westhawe, Bretton, Peterborough. Tel 265219. (7632)

WE PURCHASE FOR CASH the following: R. P. Power Transistors, Varactor Diodes, and all special components normally used in VHF/UHF Transmitting equipment. MODULAR ELECTRONICS, 95 High Street, Selsey, Sussex. PO20-0QL. Tel. Selsey 2916. (7696)

SOLARTRON CT 436 oscilloscope mains transformer wanted. Phone 0723 870884. (7841)

EQUIPMENT

BROADFIELDS AND
MAYCO DISPOSALS

21 Lodge Lane, N. Finchley
London, N12 8JG
Telephone:
01-445 2713
01-445 0749 01-958 7624

MAY WE ASSIST YOU TO
DISPOSE OF YOUR SURPLUS
AND REDUNDANT STOCKS.

We will call anywhere in the
British Isles, and pay SPOT CASH
for Electronic Components and
Equipment.

RECEIVERS AND AMPLIFIERS

HRO RX55, etc. ARSS, CR100, BRT400 G209, S840, etc., etc. in stock. R. T. & I. Electronics, Ltd. Ashville Old Hall, Ashville Rd., London, E.11. Ley 4986. (95)

SIGNAL Generators Oscilloscopes, Output Meters, Wave Voltmeters, Frequency Meters, Multi-range Meter etc., etc. in stock. R. T. & I. Electronics Ltd. Ashville Old Hall, Ashville Rd., London E.11. Ley 4986. (64)

COURSES

The Decca College

Microminiature Electronics
Courses in Practical Techniques

Short courses on the microminiature practical techniques required in the Aviation Industry are available.

The standard course lasts for three days (Tuesday to Thursday) and is approved by the Civil Aviation Authority. The course is designed for experienced avionics or electronics personnel and aims to train them to carry out practical repairs, modifications and overhauls on microminiature equipment.

Details of these and other courses from: **The Principal, The Decca College, New Road, Brixham, Devon TQ5 8NQ. Telephone: 08045-3409.**

(761)

SERVICES

EURO CIRCUITS

Printed Circuit Boards - Master layouts - Photography - Legend printing - Roller stamping - Gold plating - Flexible films - Conventional fibre glass - No order too large or too small - Fast turnaround on prototypes. All or part service available NOW... 7669

EURO CIRCUITS TD.
Highfield House
West Kingsdown
Nr. Sevenoaks, Kent. WK2344

LABELS, NAMEPLATES, FASCIAS on aluminium or plastic. Speedy delivery G.S.M. Graphic Arts Ltd., 1-5 Rectory Lane, Gulsborough (02873-4443), Yorks, U.K. (8305)

CAPACITY AVAILABLE

AIRTRONICS LTD. for coil winding Large or small production runs. Bobbin - Layer - Wave - Billar - Miniature Toroidals - Airtronics Limited, Gardner Industrial Estate, Kent House Lane, Beckenham, Kent BR3 1UG. Tel. 01-639 1147. (7158)

PCBs/WIRING/ASSEMBLY. Design, artwork, manufacture, assembly, wiring of small batches of boards, panels etc. to high standards. Quick turnaround and competitive prices. Contact us first: HALL ELECTRONICS LTD, 492 Kingston Road, London SW20. 01-542 9209.

BATCH Production Wiring and Assembly to sample or drawings. McDeane Electricals 18B Station Parade, Ealing Common, London, W.5. Tel: 01-892 8976. (7831)

CITRONICS for design, manufacture and assembly of P.C.B. we are used to the wanted yesterday situation in small or large batch quantities. We have other services available. Contact us first: Citronics, 36 Coles Road, Milton, Cambridge. (7783)

HIGHWAY ELECTRONICS, Logic design, PCB Artwork, Assembly, Testing, Custom built electronics. - Write to Unit 12, Pantnewydd Ind., Est., Pontypool, Gwent, NP4 6PD. (7742)

PRINTED CIRCUITS. Small catch-wiring, electrical testing, minicomputers undertaken by Wandronics Ltd. Skilled ex Philips workers. Phone or write for details: Wandronics Limited, Wandy Wharf, Frogmore, Wandsworth, London SW18 1HW. Tel. 01-870 6585. (7755)

SMALL BATCH PRODUCTIONS wiring assembly to sample or drawings. Specialist in printed circuits assembly. Rock Electronics, Harlow, Essex. 0279 33018. (7674)

RADIO and Radar M.P.T. and C.G.L.I. Courses Write: Principal, Nautical College, Fleetwood, FY7 8JZ (25)

RADIO AMATEURS EXAMINATION CITY & GUILDS. Pass the important Examination and obtain your GB licence with an RRC Home-study course. For details of this and other courses (GCE, professional examinations etc), write or phone: The Rapid Results College, Dept. 3W1, Tutition House, London SW19 4DS. Careers Advisory Service, 01-947 7272 or ring 01-848 1102 for prospectus only (24hr answering service). (7580)

ELECTRONIC ASSEMBLY
AND WIRING
CAPACITY AVAILABLE

M.O.D. approved

J.N. Electronic Supplies
Osiers Road, London, SW18
Tel. 01-874 6162 (7417)

PRINTED CIRCUITS. Ultra fast turnaround. Very competitive prices paper or glass. Punched or drilled. Single- or double sided. Also prototypes, artwork, photography Kilmere Circuits Ltd., 120 Garlands Road, Redhill, Surrey RH1 6NZ. Phone Redhill 88450. (7283)

SPARE CAPACITY - Quick Turn-around Specialist wiring assembly of large and small items cable forms, P.C.B. wire wrapping, panels, etc. Lewco, Wellington (0933) 677781. (7695)

RAMTEK LTD for PCB assembly using flow soldering techniques. Try us for competitive quotations against your own internal costs. No job too small, rapid turnaround. Capacity also available for wire cutting, stripping and loam manufacture. Call us today on 0242 38558 Lansdown Industrial Estate, Cheltenham, Glos. (7812)

ONE MAN WORKSHOP has capacity for wiring assembly etc. Anything considered. Contact: Jolyon Havinden, Market Place, Lechlade, Glos. (0367) 52287. (7858)

A COMPLETE and efficient PCB Service from layout through to assembly. Incorporating quality reliability, and price. No order too large or too small. Also mechanical detailing is undertaken. For details and free estimates please contact: J. S. Roberts on 01-553 2577 H.R.C. Artwork Design, 45 High Street, Maldon, Essex. (7731)

I.C.E. MULTIMETERS

TWICE the information in HALF the size

The I.C.E. range of multimeters provides an unrivalled combination of maximum performance within minimum dimensions, at a truly low cost. Plus, a complete range of add-on accessories for more ranges, more functions.

All I.C.E. multimeters are supplied complete with unbreakable plastic carrying case, test leads, etc., and a 50-plus page fully detailed and illustrated Operating and Maintenance Manual.

Now available from selected stockists. Write or phone for list, or for details of direct mail-order service.

Supertester 680R (illustrated)

20kV/V. = 1% f.s.d. on d.c.
4kV/V. = 2% f.s.d. on a.c.
40 Ranges — 10 Functions
140 x 105 x 55mm
£25.25 + VAT
(For Mail Order add 80p P&P)

Supertester 680G

20kV/V. = 2% f.s.d. on d.c.
4kV/V. = 2% f.s.d. on a.c.
48 Ranges — 10 Functions
109 x 113 x 37mm

£19.95 + VAT
(For Mail Order add 80p P&P)

Microtest 80

20kV/V. = 2% f.s.d. on d.c.
4kV/V. = 2% f.s.d. on a.c.
40 Ranges — 8 Functions
*Complete with case — only 93 x 95 x 23mm

£14.95 + VAT
(For Mail Order add 80p P&P)

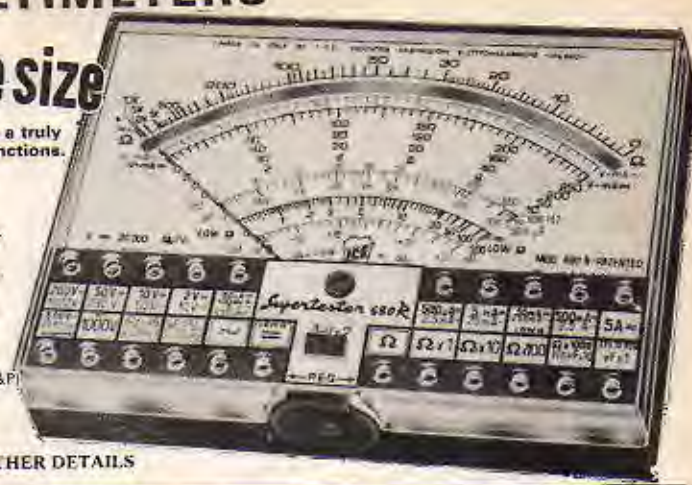

Electronic Brokers Ltd.,
49-53 Pancras Road, London NW1 2QB
Tel. 01-837 7781

WW-082 FOR FURTHER DETAILS

INDEX TO ADVERTISERS

Appointments Vacant Advertisements appear on pages 124-135

	PAGE		PAGE		PAGE
AEL Crystals Ltd	22	General Inst. Microelectronics Ltd.	2	Plessey Controls	61
Amateur Components	87	Gould Advance	13	Plessey Windings	118
Ambic International	86	H/H Electronics	84	Pinnacle Electronic Comps. Ltd.	62
Amplicon Ltd	21	Harmsworth Townley & Co. Ltd.	6	Powertran Electronics	98, 99
Antex	71	Harris Electronics (London) Ltd.	14, 20	Precision Instrument Labs.	72
Aspen Electronics Ltd.	15	Hart Electronics	90	Radio Components Specialists	95
Astra-Pak	94	Icon Designs	7	Radio Shack Ltd.	106
Audio Amateur	96	ILP Electronics Ltd.	18, 109	Ralfe P. Electronics	123
Audix Ltd.	81	Industrial Tape Applications	23	R.C.S. Electronics	82
Baker Loudspeakers Ltd.	20	Industrial T/Fair	105	Rola Celestion Ltd.	113
Barr & Stroud Ltd.	24	Integrex Ltd.	92, 93	R.S.T. Valves Ltd.	91
Barrie Electronics Ltd.	101	Interport Mains-Store Ltd.	133	RTVC	121
Bayliss, A. D. & Sons Ltd.	12	ITT Instrument Services	112	Scopex Instruments Ltd.	112
Bentley Acoustic Corp. Ltd.	122	JPS Associates	22	Semi Conductor Supplies Ltd.	87
Bi-Pak Semiconductors Ltd.	88, 89	KGM Electronics	10, 84	Service Trading Co.	111
Boss Industrial Mouldings Ltd.	17	Kothly Instruments Ltd.	81	Shure Electronics Ltd.	cover iii
C.A.E. Ltd.	19	Langrex Supplies Ltd.	91	Sintel	107
Cambridge Learning	19	Loevers-Rich Equipment Ltd.	14	SMC (Yaesu Musen)	102
Catronics	97	Lovell Electronics Ltd.	3	Southwest Technical Prods. Ltd.	11
CEC Corporation	85	Light Soldering Developments Ltd.	12	Sowter, E. A.	133
Chiltmead Ltd.	114	Linstead Mfg. Co. Ltd.	84	Special Products Ltd.	16
Chromasonics	4	Lion House	106	Strumech Engineering Ltd.	14
Communications 78	82	Lloyd, J. J. Insts. Ltd.	20	Sugden, J. E. & Co. Ltd.	22
Colomor (Electronics) Ltd.	110	Logic Leisure	122	Surrey Electronics Ltd.	105
Computer Appreciation	105	London Inst. Repair Service	101	Swanley Electronics Ltd.	86
Continental Specialities Corp.	8	Lynx (Electronics) London Ltd.	96, 97	Swift of Wilmslow	86
Crellon	9	McKnight Crystals	133	Technomatic Ltd.	108
Crimson Elektrik	21	MacInnes Laboratories Ltd.	16	Telecraft	122
Datong Electronics Ltd.	97	Magnum Audio Ltd.	103	Teletradio Hi Fi	108
Doram Electronics	106	Maplin Electronic Supplies	5	Trampus Electronics	101
Drake Transformers Ltd.	10	Marconi Instruments Ltd.	cover ii	Varian A. G.	6
Edicon	123	Marshall, A. (London) Ltd.	100	Vero Electronics Ltd.	15
E.L. Instruments	94	Martin Associates	85	Vero-Verospeed Ltd.	21
Electro/Eurotech	104	Micronics, The, Co.	22	West Hyde Developments Ltd.	110
Electronic Brokers Ltd.	115, 116, 117, 136	Mills, W.	100	West London Supplies	105
Electronic Brokers Ltd. (Second User Computer (Div.))	119	Modern Book, The	134	Wilmslow Audio	120
Elec. & E/Trader Y/Book	90	Monolith Electronics Co. Ltd.	84	Z. & I. Aero Services Ltd.	15, 104, 108
Erie Electronics Ltd.	82, 96	MultiCore Solders Ltd.	cover iv	Zettler (UK) Division	16
4 Books from W. World	83	Newbear Computer Stores	107		
Feedback Insts. Ltd.	94	Nexus	122		
Future Film Developments	97	Olson Electronics	118		

OVERSEAS ADVERTISEMENT AGENTS:

Hungary: Mrs. Edit Bajusz, Hungexpo Advertising Agency
Budapest XIV, Városliget
Telephone: 225 008 — Telex: Budapest 22-4525
INTFOIRE

Italy: Sig. C. Epia, Etas-Kompass, S.p.a. — Servizio Estero,
Via Mantegna 8, 20154 Milan
Telephone: 347051 — Telex: 37342 Kompass.

Japan: Mr. Inatsuki, Trade Media — IBPA (Japan), B 212,
Azabu Heights, 1-5-10 Roppongi, Minato-ku, Tokyo 106,
Telephone: (03) 585-0581

United States of America: Ray Barnes
IPC Business Press, 205 East 42nd Street, New York, NY
10017 — Telephone: (212) 689 5861 — Telex: 421710.
Mr. Jack Farley Jr., The Farley Co., Suite 1584, 35 East
Wacker Drive, Chicago, Illinois 60601 — Telephone: (312) 6
3074
Mr. Richard Sands, Scott, Marshall, Sands & Latta Inc., 5th
Floor, 85 Post Street, San Francisco, California 94104 —
Telephone: (415) 421 7950 — Telephones: Dascotico, San
Francisco.
Mr. William Marshall, Scott, Marshall, Sands & Latta Inc.,
1830 West Eighth Street, Los Angeles, California 90057 —
Telephone: (213) 382 6345 — Telegrams: Dascotico, Los
Angeles

Mr. Jack Mentel, The Farley Co., Suite 650, Ranna Building,
Cleveland, Ohio 44115 — Telephone: (216) 621 1919
Mr. Ray Rickles, Ray Rickles & Co., P.O. Box 2008, Miami
Beach, Florida 33140 — Telephone: (305) 532 7301
Mr. Jim Parks, Ray Rickles & Co., 3118 Maple Drive N.E.,
Atlanta, Georgia 30305, Telephone: (404) 237 7432.
Mike Loughlin, IPC Business Press, 15085 Memorial, Ste
119, Houston, Texas 77079 — Telephone: (713) 783
8673

Canada: Mr. Colin H. MacCulloch, International Advertising
Consultants Ltd., 915 Carlton Tower, 2 Carlton Street, Toronto 2
— Telephone: (416) 364 2269

*Also subscription agents.

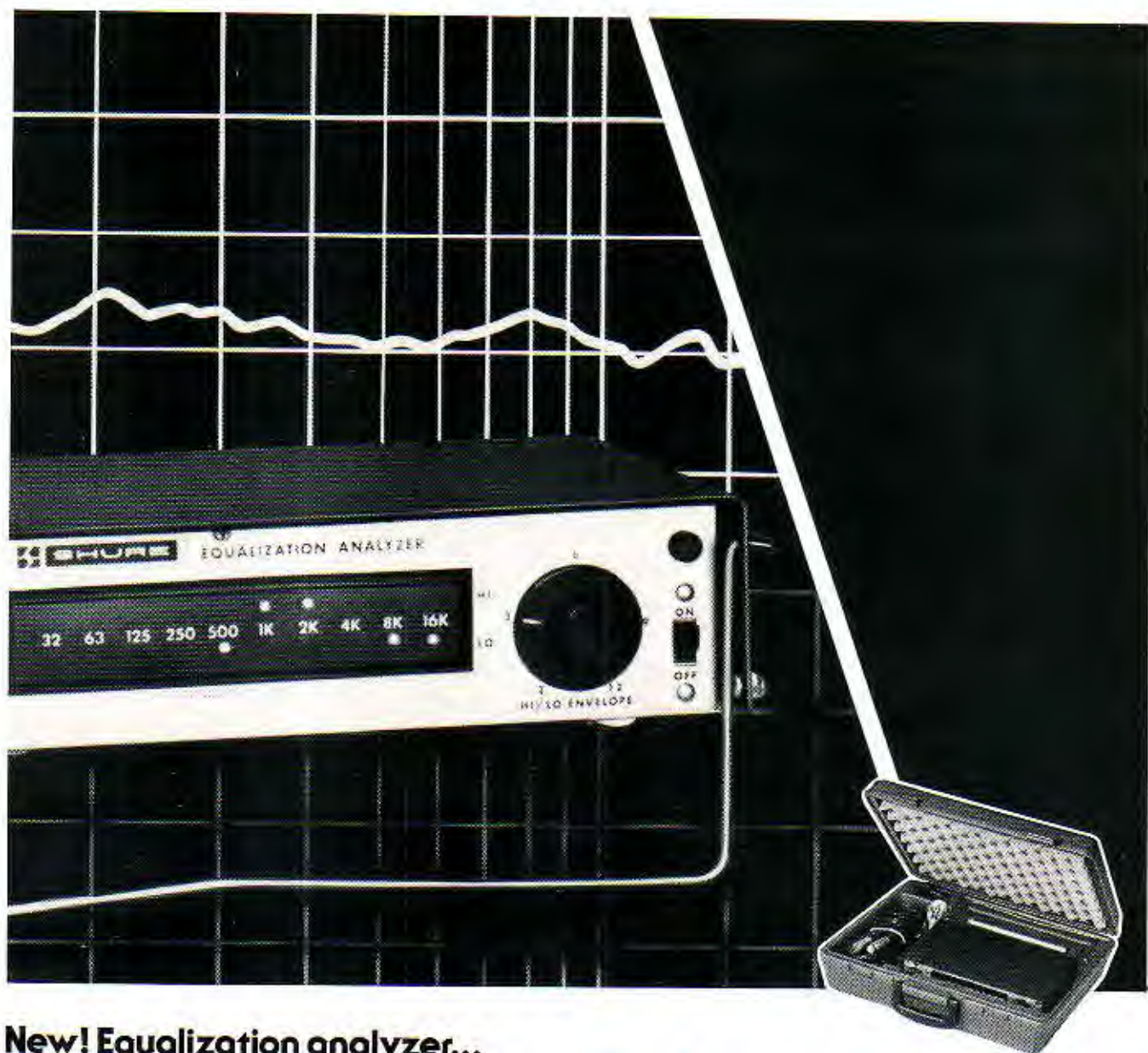

New! Equalization analyzer...

Balance a system...Balance a budget.

Quick and accurate adjustment of sound system frequency response is finally within the reach of most budgets. The Shure M615A5 Equalization Analyzer System is a revolutionary breakthrough that lets you "see" room response trouble spots in sound reinforcement and hi-fi systems—without bulky equipment, and at a fraction of the cost of conventional analyzers.

The portable, 11-pound system (which includes the analyzer, special microphone, accessories, and carrying case) puts an equal-energy-per-octave "pink noise" test signal

into your sound system. You place the microphone in the listening area and simply adjust the filters of an octave equalizer (such as the Shure SR107 or M610) until the M615 display indicates that each of 10 octaves are properly balanced. You can achieve accuracy within ± 1 dB, without having to "play it by ear."

Send for complete descriptive brochure.

Shure Electronics Limited
Eccleston Road
Maidstone ME15 6AU
Telephone: Maidstone (0622) 59881

TECHNICORNER

The M615 Analyzer's display contains 20 LEDs that indicate frequency response level in each of 10 octave bands from 32 Hz to 16,000 Hz.

A rotary hi/lo envelope control adjusts the HI LED threshold relative to the LO LED threshold. At minimum setting, the resulting frequency response is correct within ± 1 dB. Includes input and microphone preamplifier overload LEDs. A front panel switch selects either flat or "house curve" equalization.

The ES615 Omnidirectional Analyzer Microphone (also available separately) is designed specifically for equalization analyzer systems.

 SHURE®

“There’s a lot more to Multicore...”



Multicore Fluxes, Chemicals, Preservatives, Cleaners and Conformal Coatings. For highest quality soldering.



Multicore Oxide-free Solder Creams. For microcircuits and P.C.'s. Also a wide variety of pre-forms for repetitive soldering operations.

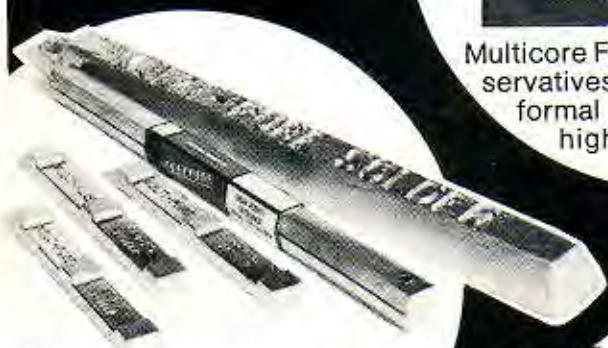

Multicore Solid Solders. In Bars, Ingots, Sticks, Wire or Pellets. For all dip and wave-soldering.

...than meets the iron!



Multicore now solders the 'impossible'. ALU-SOL 45D solders most types of aluminium and has a good corrosion resistance. Arax 96S for difficult stainless steels, being non-toxic and bright.



Multicore Solderability Testers. MK III - Tests components semi-automatically. New PTH - tests plated-through-holes in P.C. boards automatically.



“The name that stands for quality and quantity.”

Please write on your Company's letterhead for further details on your particular application.

Multicore Solders Limited,

Maylands Avenue, Hemel Hempstead, Herts HP2 7EP. Tel: Hemel Hempstead 3636. Telex: 82363.